

## SMC 系列共模线圈 SMC Series Common Mode Chokes



### 特征 Features

超薄小型化	Low Profile & Small Size
温度最高125°C	High Temperature, Up to 125°C
低信号损耗	Lower Signal Loss



### 应用 Applications

笔记本电脑	Notebook
智慧型手机	Smart Phone
共模信号滤波	Common Mode Filtering

### 电路接线图 Circuit

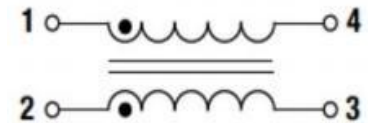

### 产品规格型号表示方法 How to Order

SMC   1206      -   121   P   S  
①            ②            ③            ④            ⑤            ⑥

①	②		③		④	⑤	⑥	
产品代号 Product Code	规格尺寸(L×W×T) Dimensions(mm)		型号规格 Type Code		阻抗值 Impedance	误差 Tolerance	应用领域 Application	
SMC 系列 SMC Series	1206	3.2×1.6×2.2	M 无	标准品 For Standard 低电阻型号 For Low DCR	1R0=1.0Ω 100=10Ω 101=100Ω 102=1000Ω	K=10% M=20% P=25% N=30% Y=其他误差	S C T	标准品 For Standard. 车载品 125°C Automotive 125°C. 特制品 For Special.

### 外型尺寸 Dimensions(Unit:mm)

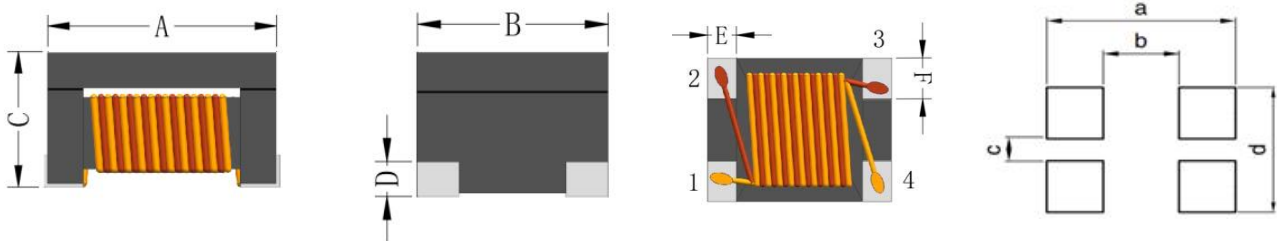

Type Name	A	B	C	E	F	a	b	c	d
SMC1206	3.2±0.2	1.6±0.2	2.0±0.2	0.64 Typ.	0.66 Typ.	4.1 Typ.	2.0 Typ.	0.5 Typ.	1.6 Typ.

性能参数 Electrical Characteristics

Part No.	Common Mode Impedance	DCR	Rate Current	Rate Voltage	Insulation Resistance
Units	( $\Omega$ )@100MHz/0.5V	( $\Omega$ )Max.	(mA)Max.	(V)	(M $\Omega$ )Min.
SMC1206-600PS	60±25%	0.3	400	50	10
SMC1206-900PS	90±25%	0.3	370	50	10
SMC1206-121PS	120±25%	0.3	350	50	10
SMC1206-161PS	160±25%	0.4	340	50	10
SMC1206-261PS	260±25%	0.5	310	50	10
SMC1206-361PS	360±25%	0.6	300	50	10
SMC1206-601PS	600±25%	0.8	260	50	10
SMC1206-102PS	1000±25%	1.0	230	50	10
SMC1206-222PS	2200±25%	1.2	200	50	10

备注 Remark

Temperature : 20±2°C

Humidity : 60 to 75% (RH)

Atmospheric Pressure : 86 to 106 kPa

测试设备 Test Equipment

共模阻抗  
Common Mode Impedance

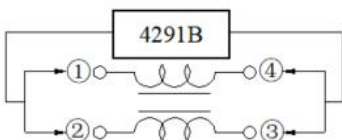

直流电阻  
DC Resistance

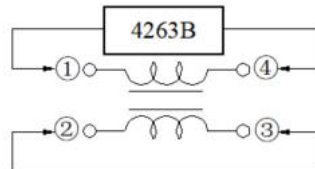

绝缘电阻  
Insulation Resistance

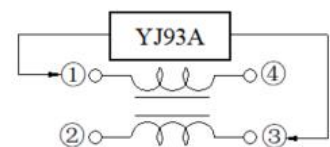

推荐回流焊条件 Recommended Reflow Soldering Conditions

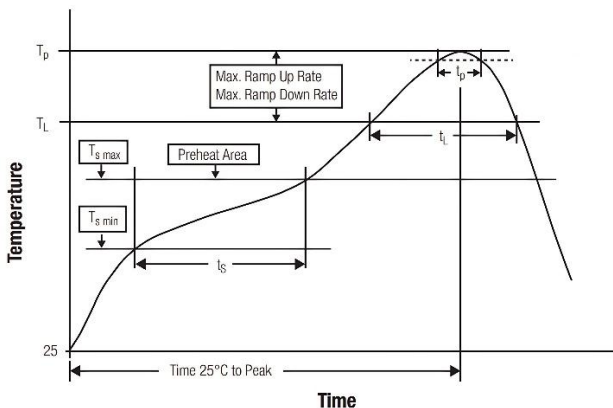

Profile Feature	Lead-Free Assembly
Preheat Temperature Min ( $T_s$ min)	150°C
Preheat Temperature Max ( $T_s$ max)	200°C
Preheat Time $t_s$ from $T_s$ min to $T_s$ max	60-120 seconds
Average Ramp-Up Rate ( $T_L$ to $T_p$ )	3°C /second max.
Liquidous Temperature ( $T_L$ )	217°C
Time $t_L$ maintained above $T_L$ ( $t_L$ )	60-150 seconds
Peak/Classification Temperature ( $T_p$ )	255°C
Time within 5°C of actual peak temperature ( $t_p$ )	20-30 second
Ramp-down Rate ( $T_p$ to $T_L$ )	6 °C/second max.
Time 25 °C to Peak Temperature	8 minutes max.

**包装材料及规格 Packaging Materials and Specifications (mm)**

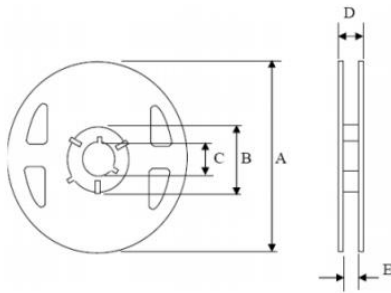

A	178
B	60.0
C	13.0
D	14.4
E	8.4

**包装方式及数量 The Packing Method and Quantity (mm)**

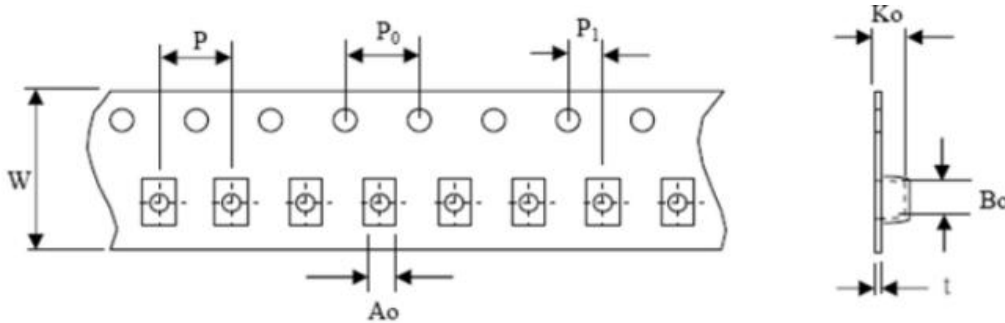

Part No.	W	P	P0	P1	A0	B0	K0	t	pcs/Reel
<b>SMC1206</b>	8.0	4.0	4.0	2.0	1.85	1.60	2.15	0.24	2000

**剥离强度 Peeling Strength**

在箭头方向上撕下10克到100克(0.1N到1.0N)的力,剥离速度300mm/MIN以上.

The force tearing off cover 10 to 100 grams (0.1N to 1.0N) in the arrow direction under the following conditions, The stripping speed is above 300mm/minute.

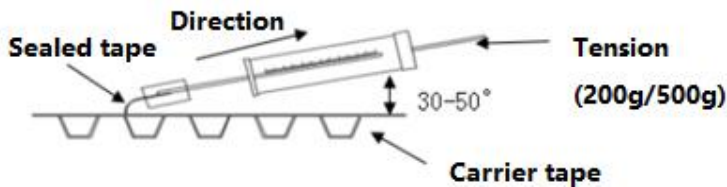



## 内外箱标识内容 Inside and Outside Box Identification Content

 创一科技 科技创一  
CYGE TECHNOLOGY TECHNOLOGY FIRST

Made in China

Customer Name: <HSF/RoHS>

  
P/O: 

  
Customer P/N:

  
CYGE P/N:

  
LOT NO:                      DATE:                      QTY:

 匠心致远 追求卓越 感动人心  
Following ingenuity, pursuing, excellence, touching hearts

## 储存条件/注意事项 Storage Conditions/Note things

1. 贮存温度、湿度条件 Storage temperature and humidity conditions :

1.1. 产品包装与载体: -5℃ ~ +40℃, 低于60% RH.

Product packing with Carrier tape: -5℃ ~ +40℃ and less than 60% RH.

1.2. 单独的产品: -20℃ ~ +60℃, 低于60% RH.

Product alone: -20℃ ~ +60℃ and less than 60% RH.

2. 产品在6个月内使用(注意:产品一经拆开包装,须尽快使用).

Products should be used within 6 months.

(Note that the product should be used as soon as possible once it is folded) .

3. 包装材料应保存在空气中不存在氯或硫的地方.

The packaging material should be kept where no chlorine or sulfur exists in the air.

4. 不要用手指触摸电极(焊接端子),因为这可能导致焊接能力的下降.

Do not touch the electrodes (soldering terminals) with fingers as this may lead to deterioration of solder ability.

5. 个别零件强烈建议使用镊子或真空取料机散装搬运应减少磨损和机械冲击.

The use of tweezers or vacuum pick-ups is strongly recommended for individual components.

Bulk handling should ensure that abrasion and mechanical shock are minimized.