



Y. LIN ELECTRONICS CO., LTD.

Data Sheet

Customer: _____
Part No: M4.8BRGB9UC1A
Sample No: _____
Description: 4.8mm Mushroom Red/Green/Blue LED
Item No: _____

Customer			
Check	Inspection	Approval	Date

Y.LIN			
Drawn	Check	Approval	Date
			2014-10-13

TEL:0769-87181888 FAX:0769-87187333

E-mail:yonglin@y-lin.com Http://www.yong-lin.net

Mainland address:Jinhe the third Industrial Zone,Zhangmutou Town

Dongguan Guangdong China

H.K address:Unit 503 5/F,Silvercord Tower 230 Canton Road Tsimshatsui



M4.8BRGB9UC1A

Features:

- . Choice of various viewing angles
- . Available on tape and reel.
- . Reliable and robust
- . Pb free
- .The product itself will remain within RoHS compliant version.



Technical Data Sheet

This product is generally used as indicator and luminary for electronic equipment such as household appliance, communication equipment, and dashboard

Applications

- TV set
- Monitor
- Telephone
- Computer



Package Dimensions:

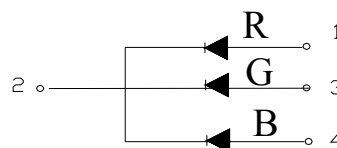
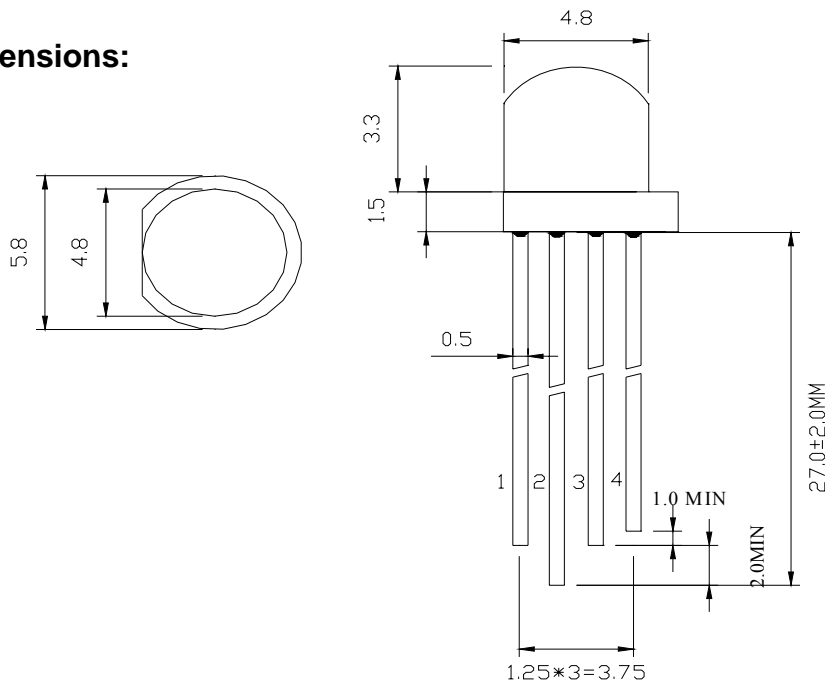

NOTES

- 1.All dimensions are in millimeters .
- 2.Tolerance is $\pm 0.25\text{mm}$ unless otherwise noted.



M4.8BRGB9UC1A

Selection Guide

Part No.	Dice	Lens Type	Luminous intensity(mcd) @ 20mA			Viewing Angle
			Min	Typ	Max	
M4.8BRGB9UC1A	(R)AlGaInP	Water Clear	100	150	230	201/2 110
	(G)InGaN		500	800	1300	
	(B)InGaN		150	230	350	

Note:

1. 1/2 is the angle from optical centerline where the luminous intensity is 1/2 the optical centerline value.

2. the above luminous intensity measurement allowance tolerance $\pm 15\%$

Electrical / Optical Characteristics at Ta=25°C

Parameter	Symbol	Min.(R/G/B)	Typ.(R/G/B)	Max.(R/G/B)	Units	test conditions
Forward Voltage	VF	1.8/2.8/2.8	2.0/3.2/3.2	2.4/3.6/3.6	V	IF=20mA
Reverse Current	IR	--	--	10	uA	VR = 5V
Dominate Wavelength	λ_d	620/515/463	--	630/525/475	nm	IF=20mA

Absolute Maximum Ratings at Ta=25°C

Parameter	Symbol	Rating	Units
Power Dissipation	Pd(R/G/B)	60/90/90	mW
DC Forward Current	IF	25	mA
Peak Forward Current [1]	IFP	60	mA
Reverse Voltage	VR	5	V
Operating Temperature	Topr	-20~+80	°C
Storage Temperature	Tstg	-40~+100	°C
Lead Soldering Temperature [1.6mm(.063") From Body]		260°C for 5 seconds	

Note:

1. 1/10 Dut cycle, 0.1ms pulse width.

2. The above forward voltage measure ment allowance tolerance $\pm 0.1V$.



M4.8BRGB9UC1A

Typical optical characteristics curves

Ambient Temperature VS. Forward Current

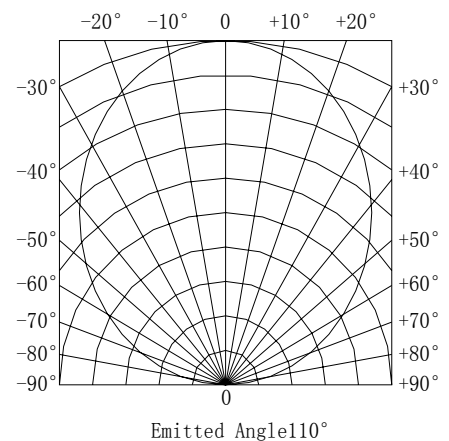
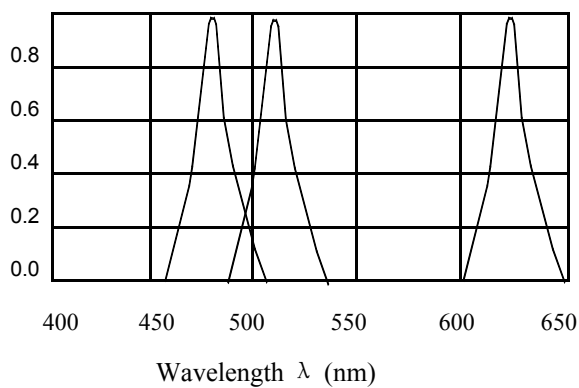
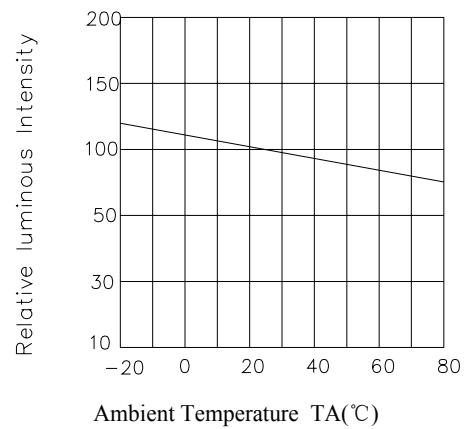
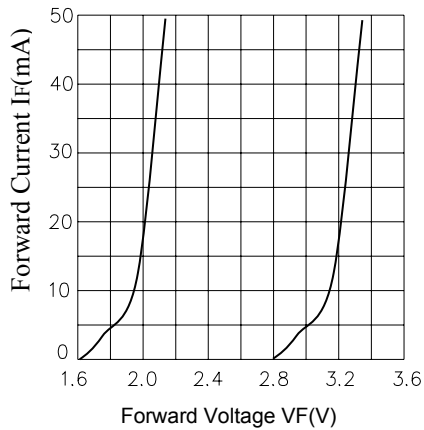
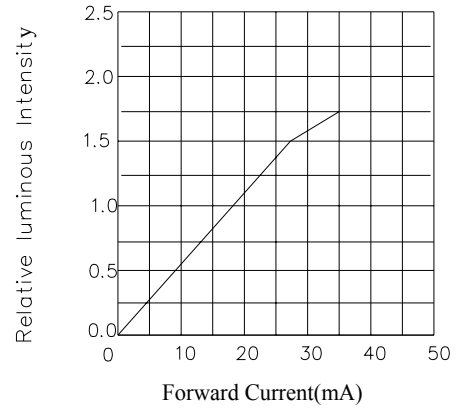
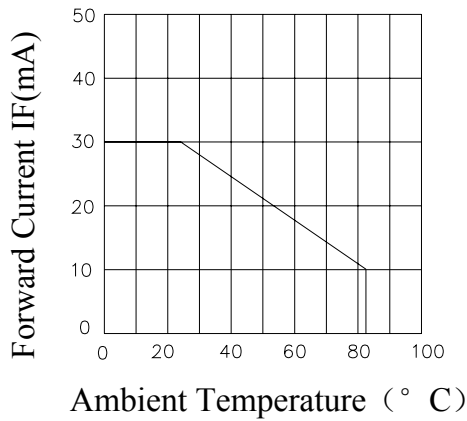



M4.8BRGB9UC1A

Reliability Test

Classification	Test Item	Test Condition	Reference Standard
Endurance Test	Operation Life	Ta=Under Room Temperature As Per Data Sheet Maximum Rating *Test Time=1000HRS(-24HRS,+72HRS)	MIL-STD-750D:1026(1995) MIL-STD-883D:1005(1991) JIS C 7021:B-1(1982)
	High Temperature High Humidity Storage	Ta=65±5°C RH=90~95% Test Time=240HRS± 2HRS	MIL-STD-202F:103(1980) JIS C 7021:B-11(1982)
	High Temperature High Humidity Reverse BIAS	Ta=65±5°C RH=90~95% Test Time=500HRS(-24HRS,+48HRS)	JIS C 7021:B-11(1982)
	High Temperature Storage	Ta=105±5°C *Test Time=1000HRS(-24HRS,+72HRS)	MIL-STD-883D:1008(1991) JIS C 7021:B-10(1982)
	Low Temperature Storage	Ta=55±5°C *Test Time=1000HRS(-24HRS,+72HRS)	JIS C 7021:B-12(1982)
	Environmental Test	Temperature Cycling	105°C ~ 25°C ~ -55°C ~ 25°C 30mins 5mins 30mins 5mins 10Cycles
Thermal Shock		105°C±5°C ~ -55°C±5°C 10mins 10mins 10Cycles	MIL-STD-202F:107D(1980) MIL-STD-750D:1051(1995) MIL-STD-883D:1010(1991)
Solder Resistance		T.sol=260±5°C Dwell Time=10±1secs	MIL-STD-202F:210A(1980) MIL-STD-750D:2031(1995) JIS C 7021:A-1(1982)
Solderability		T.sol=230±5°C Dwell Time=5±1secs	MIL-STD-202F:208D(1980) MIL-STD-750D:2026(1995) MIL-STD-883D:2003(1991) JIS C 7021:A-2(1982)

The appearance and specifications of the product may be modified for improvement, without prior notice



M4.8BRGB9UC1A

1.Storage

It is recommended that LEDs out of their original packaging are used within three months.

For extended storage out of their original packaging, it is recommended that the LEDs be stored in a sealed container with appropriate desiccant or in desiccators with nitrogen ambient.

2. Cleaning

Use alcohol-based cleaning solvent such as isopropyl alcohol to clean the LEDs if necessary.

3.Soldering

When soldering leave a minimum of 2mm clearance from the base of the lens to the soldering point.

Dipping the lens into the solder must be avoided.

Do not apply any external stress to the lead frame during soldering while the LED is at high temperature.

Recommended soldering conditions:

Soldering iron		Wave soldering	
Temperature	320°C Max	Pre-heat Pre-heat time	100°C Max 60 sec.Max
Soldering time	3 sec.Max (one time only)	Solder wave Soldering time	260°C Max 5 sec.Max

Note: Excessive soldering temperature and/or time might result in deformation of the LED lens or catastrophic failure of the LED.

4.Drive Method

An LED is a current-operated device, In order to ensure intensity uniformity on multiple LEDs connected in parallel in an application, it is recommended that a current limiting resistor be incorporated in the drive circuit, in series with each LED as shown in Circuit A below.

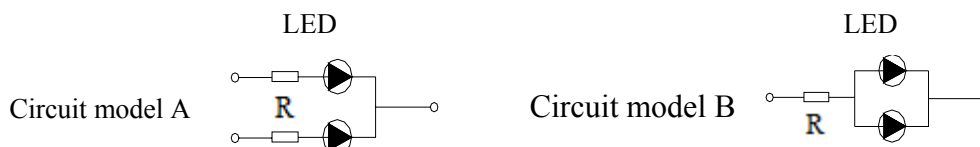

(A) Recommended circuit

(B) The brightness of each LED might appear different due to the differences in the I-V characteristics of those LEDs.