



Y. LIN ELECTRONICS CO., LTD.

Data Sheet

Customer: _____
Part No: _____ YLS150/LW/21/11-H _____
Sample No: _____ YL20180301-411Y _____
Description: _____ 1206 Cool White SMD _____
Item No: _____ 23.06.02832 _____

Customer			
Check	Inspection	Approval	Date

Y.LIN			
Drawn	Check	Approval	Date
			2017/10/10

TEL:0769-87181888

FAX:0769-87187333

E-mail:yonglin@y-lin.com [Http://www.yong-lin.net](http://www.yong-lin.net)

Mainland address:Jinhe the third Industrial Zone,Zhangmutou Town

Dongguan Guangdong China

H.K address:Unit 503 5/F,Silvercord Tower 230 Canton Road Tsimshatsui



Features:

- . Reflow Solderable
- . High Luminous Intensity and Low Power Dissipation
- . Good Reliability and Long Life
- . Complied With RoHS Directive

Technical Data Sheet

This product is generally used as indicator and luminary for electronic equipment such as household appliance, communication equipment, and dashboard.

Applications

- Optical indicator
- Indoor display
- Backlighting in dashboard and switch
- Flat backlighting for LCD, symbol and display
- General use

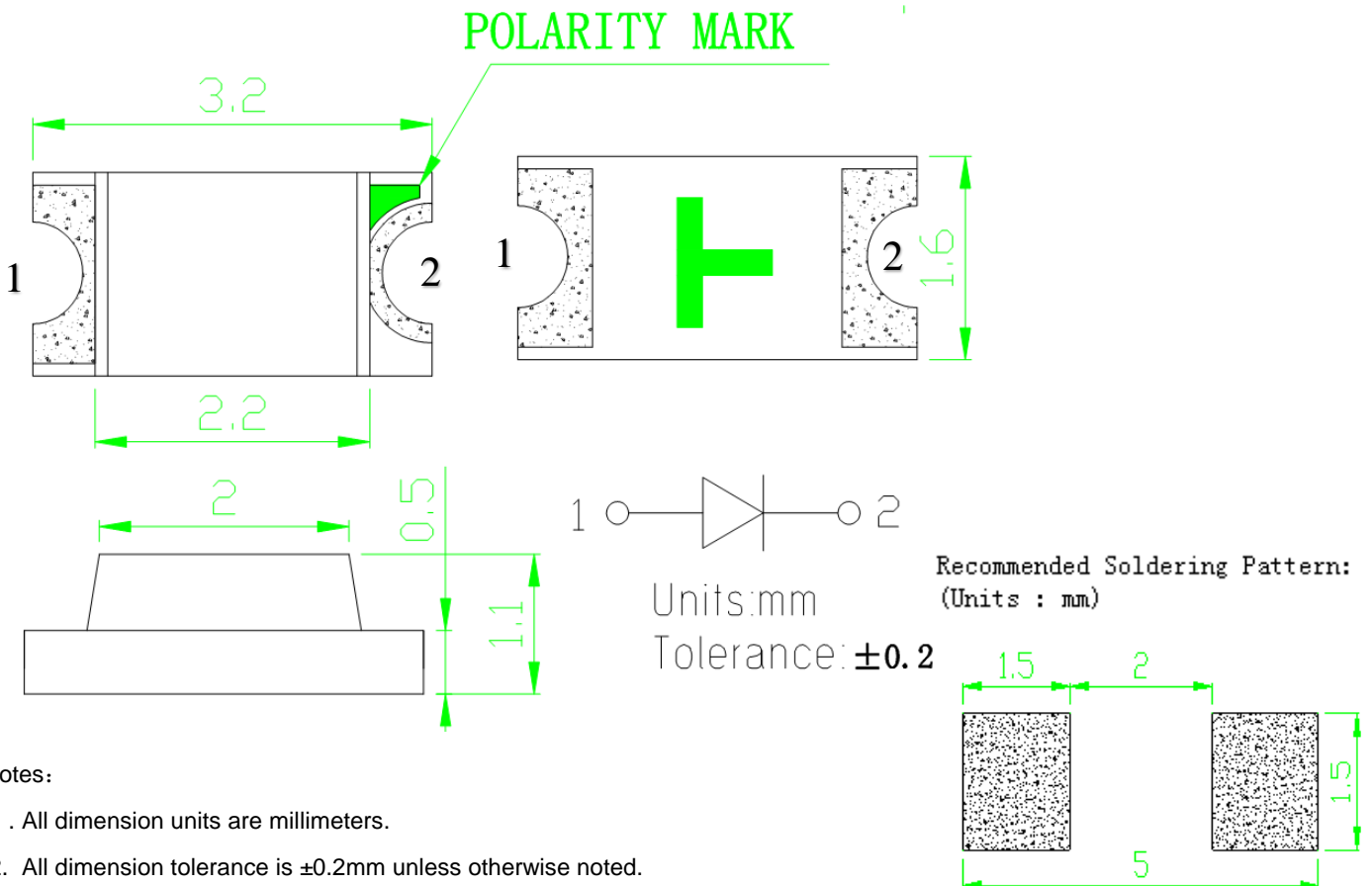

Notes:

- 1 . All dimension units are millimeters.
2. All dimension tolerance is ± 0.2 mm unless otherwise noted.



Selection Guide

Part No.	Dice	Lens Type	Luminous intensity(mcd) @ 5mA			Viewing Angle
			Min	Typ	Max	
YLS150/LW/21/11-H	Blue (InGaN)	Yellow Diffused	150	--	300	2θ1/2 120

Note:

- 1.2θ1/2 is the angle from optical centerline where the luminous intensity is 2θ1/2 the optical centerline value.
- 2.The above luminous intensity measurement allowance tolerance ±10%

Electrical / Optical Characteristics at Ta=25 °C

Parameter	Symbol	Min.	Typ.	Max	Units	test conditions
Forward Voltage	VF	2.6	--	3.2	V	IF=5mA
Reverse Current	IR	--	--	10	uA	VR = 5V
Color Temperature	Tc	8000	--	12000	K	IF=5mA

Absolute Maximum Ratings at Ta=25 °C

Parameter	Symbol	Rating	Units
Power Dissipation	Pd	90	mW
DC Forward Current	IF	20	mA
Peak Forward Current [1]	IFP	40	mA
Reverse Voltage	VR	5	V
Electrostatic Discharge (HBM)	ESD	2000	V
Operating Temperature	Topr	-40~+85	°C
Storage Temperature	Tstg	-40~+100	°C

Note:

1. 1/10 Dut cycle,0.1ms pulse width.
2. The above forward voltage measurement allowance tolerance ±0.1V.



Typical optical characteristics curves

Ambient Temperature VS. Forward Current

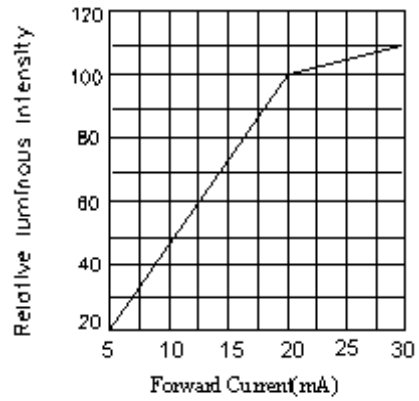
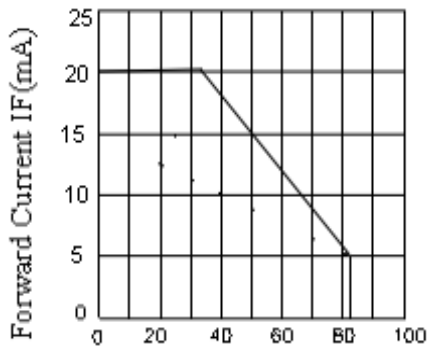

Ambient Temperature (°C)

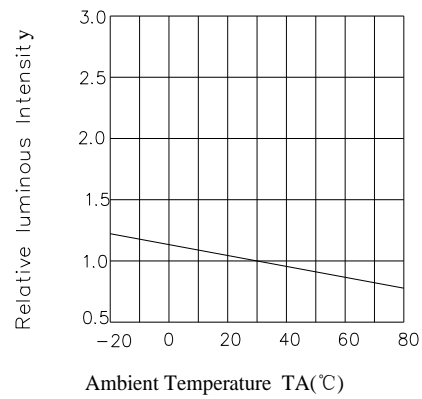
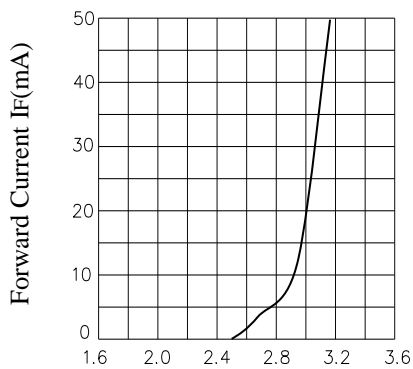

Forward Voltage VF(V)

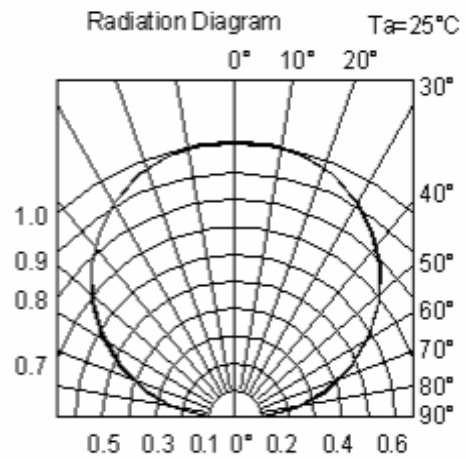
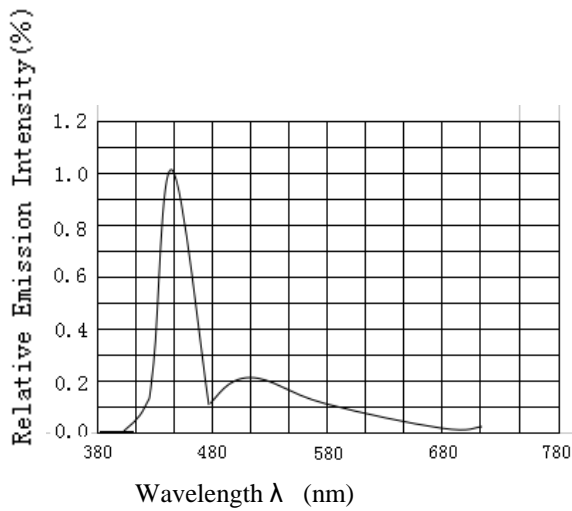



Y. LIN ELECTRONICS CO., LTD.

YLS150/LW/21/11-H

Bin Color

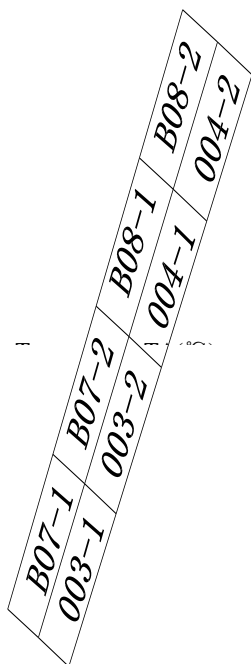

BIN	X1	Y1	X2	Y2	X3	Y3	X4	Y4
B07-1	0.2789	0.2651	0.2759	0.2667	0.2803	0.2752	0.2833	0.2736
B07-2	0.2833	0.2736	0.2803	0.2752	0.2845	0.2834	0.2876	0.2817
B08-1	0.2876	0.2817	0.2845	0.2834	0.2886	0.2916	0.2919	0.2899
B08-2	0.2919	0.2899	0.2886	0.2916	0.2928	0.2998	0.2962	0.2980
003-1	0.2818	0.2635	0.2789	0.2651	0.2833	0.2736	0.2864	0.2720
003-2	0.2864	0.2720	0.2833	0.2736	0.2876	0.2817	0.2908	0.2800
004-1	0.2908	0.2800	0.2876	0.2817	0.2919	0.2899	0.2951	0.2881
004-2	0.2951	0.2881	0.2919	0.2899	0.2962	0.2980	0.2995	0.2962

Tolerance on each Hue (x, y) bin is +/- 0.01.



Reliability Test Items And Conditions

The reliability of products shall be satisfied with items listed below.

Confidence level :90%

LTPD :10%

Test Items	Test conditions	Quantity	Judging Criteria
Solderability	Solder Temperature: 240°C Solder Duration: (3.5±0.5) sec.	22	Solderable Area Over 95%
Thermal Shock Followed by High Temperature And High Humidity Cyclic	-40°→10min 5 Cycles ↑ ↓ shift(2~3)min 100°C →10 min. 25°C~55°C (90%~95%) RH 2 Cycles for 48 hrs., Recover for 2 hrs	22	C=0 & I**
Resistance For Soldering Heat	Reflow Soldering	22	C=0 & I**
DC Operating Life	1000 hrs. Forward Current: 20mA	22	C=0 & I**
High Temperature Storage	100°C → 1000 hrs	22	C=0 & I**
High Temperature And High Humidity Cyclic	25°C~55°C (90%~95%) RH 6 Cycles for 144 hrs., Recover for 2 hrs.	22	C=0 & I**

The technical information shown in the data sheets are limited to the typical characteristics and circuit examples of the referenced products. It does not constitute the warranting of industrial property nor the granting of any license.



Y. LIN ELECTRONICS CO., LTD.

YLS150/LW/21/11-H

SMT Reflow Soldering Instructions

- 1.Reflow soldering should not exceed once.
- 2.In soldering process , do not stress on the LEDs during heating .

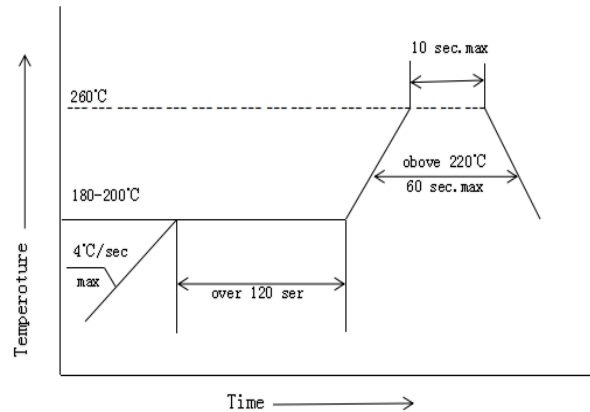

Soldering iron

- 1.When hand soldering, the temperature of the iron must lower than 300°C for 3 seconds
- 2.The hand solder should be done only one time

Repairing

Repair should not be done after the LEDs have been soldered. When repairing is unavoidable, a double-head soldering iron should be used (as below figure). It should be confirmed beforehand whether the characteristics of LEDs will or will not be damaged by repairing.

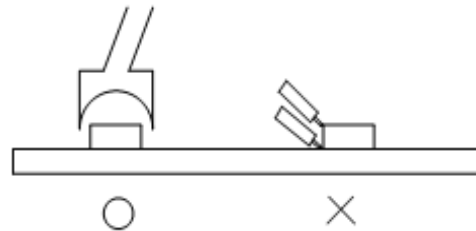

Storage

The package is sealed:

- 1.Recommended storage condition :At 5°C~30°C and relative humidity 90% RH max.
- 2.It is recommended that SMD out of their original packaging are used within one year.

The package is opened:

- 1.After this bag is opened ,devises that will be applied to infrared to infrared reflow,vapor-phase reflow.
 - a.Completed within 672 hour.
 - b.Stored at 5°C~30°C and 60% RH or less.

Handling Precautions

- 1.Do not stack together assembled PCBs containing LEDs. Impact may scratch the silicone lens or damage.

- 2.Not available in the situation of acidity for PH.

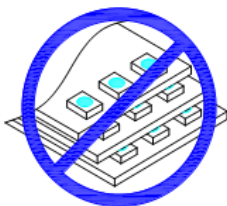



Packaging

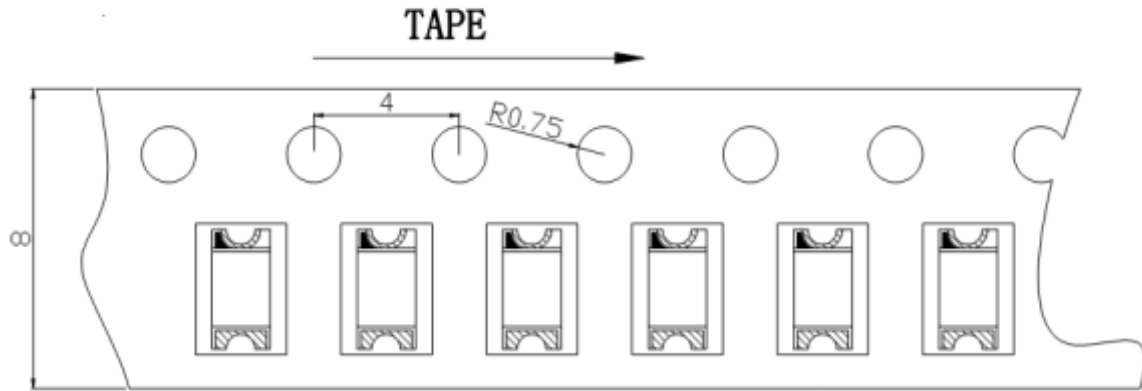

Package: 3000 pcs/reel

Reel Dimensions

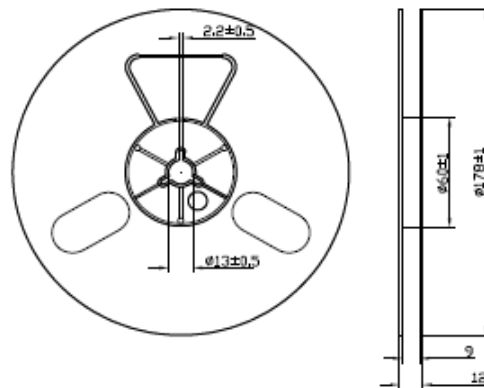

Note: The tolerances unless mentioned is ± 0.1 mm, Unit: mm

Moisture Resistant Packaging

