



Y. LIN ELECTRONICS CO., LTD.

Data Sheet

Customer: _____
Part No: _____ YL4.8BTSCK24S61-C _____
Sample No: _____
Description: _____ 4.8mm Phototransistor _____
Item No: _____

Customer			
Check	Inspection	Approval	Date

Y.LIN			
Drawn	Check	Approval	Date
			2014-7-22

TEL:0769-87181888 FAX:0769-87187333

E-mail:ylin02@y-lin.com Http://www.yong-lin.net

Mainland address:Jinhe the third Industrial Zone,Zhangmutou Town

Dongguan Guangdong China

H.K address:Unit 503 5/F,Silvercord Tower 230 Canton Road Tsimshatsui



Features:

- . Mechanically and spectrally matched to the phototransistor.
- . Rohs compliant.

Description

- . This devices are made with PIN GaAs.

Package Dimensions:

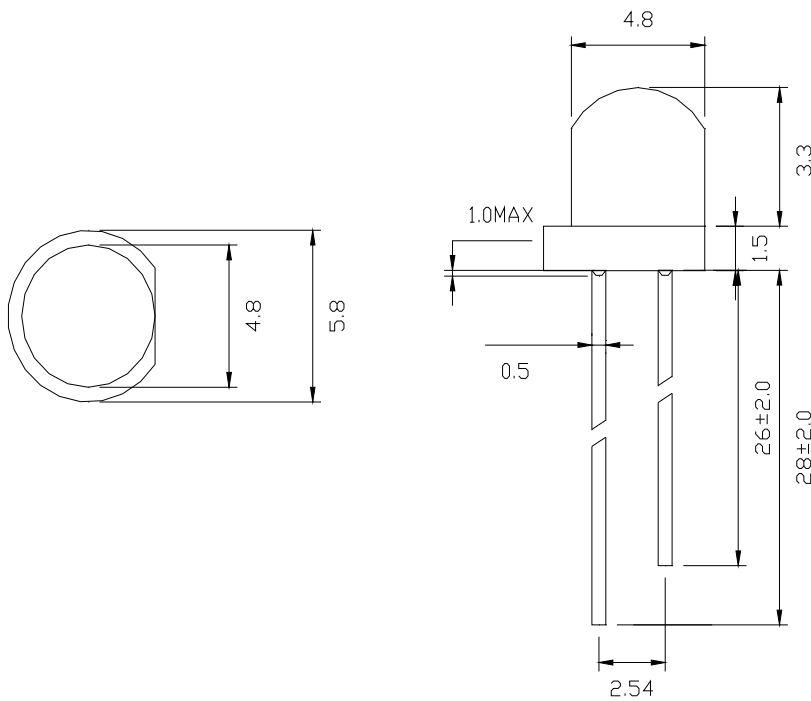

NOTES

- 1.All dimensions are in millimeters .
- 2.Tolerance is $\pm 0.25\text{mm}$ unless otherwise noted.



Part No	Material			Lens Color		
PT	Silicon			WaterClear		
Parameter	Symbol	Min.	Typ.	Max	Unit	Test Condition
Collector Dark Current	I_{ce0}			100	nA	VR=5V
On Strte Collector Current	$I_{C(on)}$	0.5	1		mA	Ee=1mw/cm2 /VCE=5v
Controlled Angle	$2\theta_{1/2}$		110		deg	



Electrical / Optical Characteristics at Ta=25°C

Parameter	Symbol	Min.	Typ.	Max	Units	test conditions
Rang of Spectral Bandwidth	$\lambda_{0.5}$	400		1200	nm	Vs=5v Ev=0
Peak Wavelength	λ_p		940		nm	
Collector-Emitter Breakdown Voltage	Bvceo	30		100	V	IC=100uA Ee=0mw/cm ²
Emitter-Collector Breakdown Voltage	Bveco		6.5		V	
Collector-Emitter Saturation Voltage	VCE(sat)			0.4	V	IC=2mA IB=100uA
collector Dark Current	Iceo			100	nA	VR=5V
Rise/fall time	tr/tf		15/15		us	VCE=5v IC=1mA RL=1000Ω

Note:

- 1.1/2 is the angle from optical centerline where the luminous intensity is 1/2 the optical centerline value.
- 2.the above luminous intensity measurement allowance tolerance $\pm 15\%$

Absolute Maximum Ratings at Ta=25°C

Parameter	Symbol	Rating	Units
Collector-Emitter Voltage	Vceo	30	V
Emitter-Collector Voltage	Veco	5	V
Collector Current	IC	20	mA
Power Dissipation	PD	75	mW
Operating Temperature	Topr	-20~+80	°C
Storage Temperature	Tstg	-40~+100	°C
Lead Soldering Temperature [1.6mm(.063") From Body]		260°C for 5 seconds	

Note:

1. 1/10 Dut cycle,0.1ms pulse width.
2. The above forward voltage measurement allowance tolerance $\pm 0.1V$.

Typical optical characteristics curves

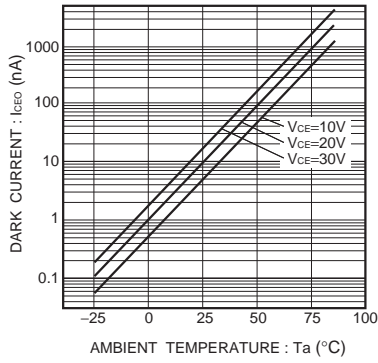

Fig.1 Dark current vs. ambient temperature

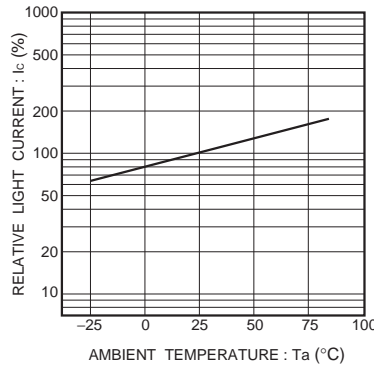

Fig.2 Relative output vs. ambient temperature

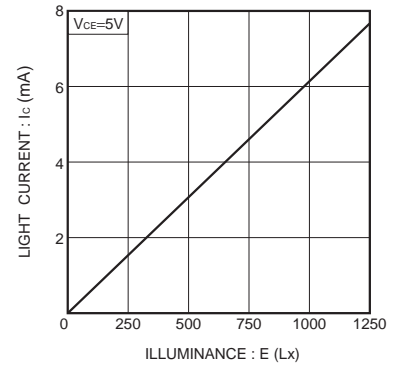

Fig.3 Light current vs. irradiance

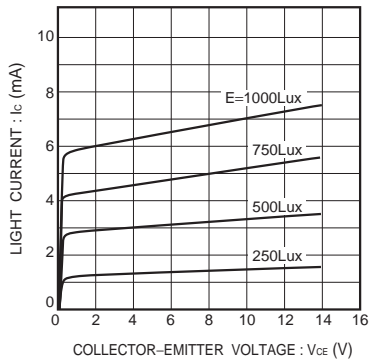

Fig.4 Output characteristics

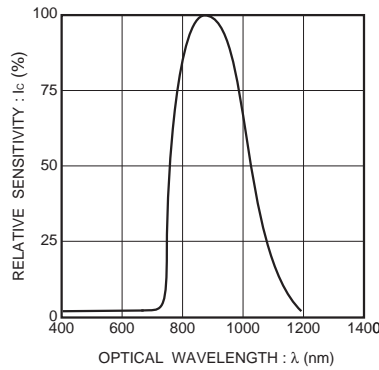

Fig.5 Spectral sensitivity

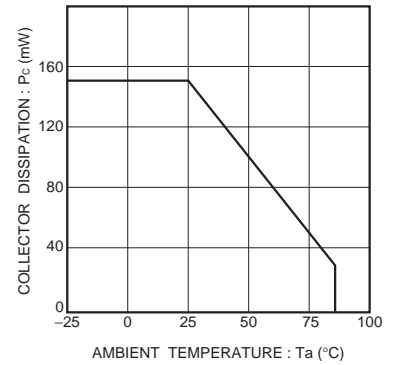

Fig.6 Collector dissipation vs. ambient temperature

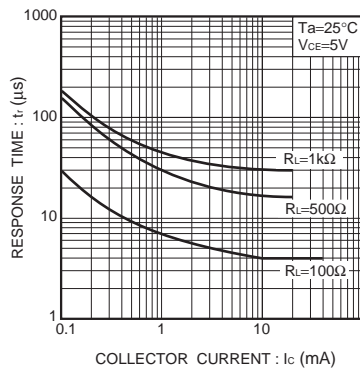
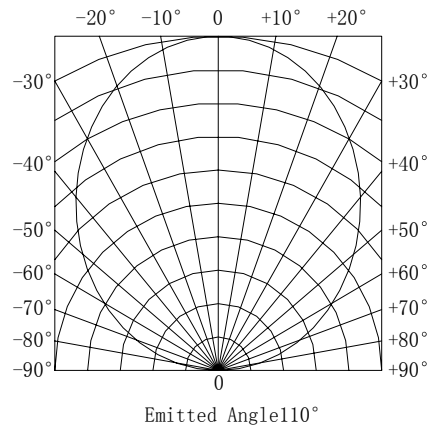

Fig.7 Response time vs. collector current





1. Application:

- Infrared applied system
- Camera
- Printer
- Optoelectronic switch
- Cockroach catcher

2. Cleaning

Use alcohol-based cleaning solvent such as isopropyl alcohol to clean the LEDs if necessary.

3. Soldering

When soldering leave a minimum of 2mm clearance from the base of the lens to the soldering point.

Dipping the lens into the solder must be avoided.

Do not apply any external stress to the lead frame during soldering while the LED is at high temperature.

Recommended soldering conditions:

Soldering iron		Wave soldering	
Temperature	320°C Max	Pre-heat Pre-heat time	100°C Max 60 sec.Max
Soldering time	3 sec.Max (one time only)	Solder wave Soldering time	260°C Max 5 sec.Max

Note: Excessive soldering temperature and/or time might result in deformation of the LED lens or catastrophic failure of the LED.

4. Lead Forming & Assembly

During lead forming, the leads should be bent at point at least 3mm from the base of PIN lens.

Do not use the base of the lead frame as a fulcrum during forming.

Lead forming must be done before soldering, at normal temperature.

During assembly on PCB, use minimum clinch force possible to avoid excessive mechanical stress.

5. Protece Of ESD

Since the device is static sensitive, it is requested that anti-static measures should be taken on human body, all devices (including soldering iron) and equipment, machinery, desk and ground.