



# Y. LIN ELECTRONICS CO., LTD.

## Data Sheet

---

Customer: \_\_\_\_\_  
Part No: \_\_\_\_\_ 3528 \_\_\_\_\_  
Sample No: \_\_\_\_\_  
Description: \_\_\_\_\_ 3528 White SMD \_\_\_\_\_  
Item No: \_\_\_\_\_

Customer			
Check	Inspection	Approval	Date

Y.LIN			
Drawn	Check	Approval	Date
			2018/3/30

Mainland address: Jinhe The Third Industrial Zone, Zhangmutou Town, Dongguan, Guangdong, China

H.K address: Unit 503 5/F, Silvercord Tower 230 Canton Road Tsimshatsui

TEL: 0769-87181888 FAX: 0769-87187333 E-mail: ylin19@y-lin.com Http://www.yong-lin.net

---



## Features:

- . Reflow Solderable
- . High Luminous Intensity and Low Power Dissipation
- . Good Reliability and Long Life
- . Complied With RoHS Directive

## Technical Data Sheet

This product is generally used as indicator and luminary for electronic equipment such as household appliance, communication equipment, and dashboard.

## Applications

- Optical indicator
- Indoor display
- Backlighting in dashboard and switch
- Flat backlighting for LCD, symbol and display
- General use

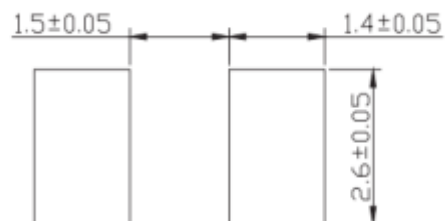
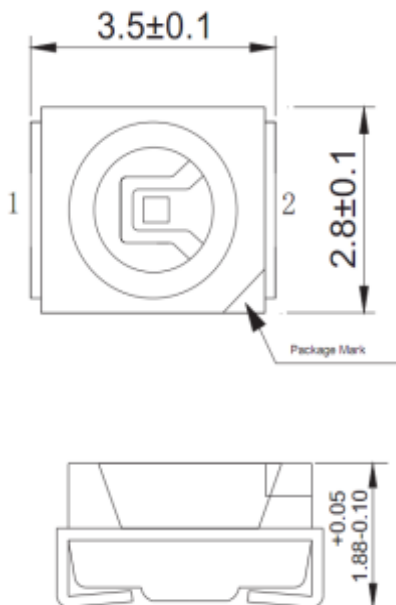

### Notes:

1. All dimension units are millimeters.
2. All dimension tolerance is  $\pm 0.2$ mm unless otherwise noted.



# Y. LIN ELECTRONICS CO., LTD.

## product model explain

YL2835/XX/80/XX/3/P1/150-L

company code

size

color temperature

Ra/CRI

luminance

voltage

support

using the current

industry code

## Production List

Part No.	Luminous Flux(LM)	voltage(V)
YL3528/XX/70/XX/3/P2/20-L	5.0-12	2.8-3.6
YL3528/XX/80/XX/3/P2/20-L		
YL3528/XX/90/XX/3/P2/20-L		



## Selection Guide

Dice	Lens Type	Luminous Flux(Lm) 20mA			Viewing Angle
		Min	Typ	Max	2θ1/2
Blue (InGaN)	Yellow Diffused	5	--	12	120

Note:

- 1.2θ1/2 is the angle from optical centerline where the luminous intensity is .2θ1/2 the optical centerline value.
- 2.The above luminous intensity measurement allowance tolerance ±10%

## Electrical / Optical Characteristics at Ta=25 °C

Parameter	Symbol	Min.	Typ.	Max	Units	test conditions
Forward Voltage	VF	2.8	3	3.6	V	IF=20mA
Reverse Current	IR	--	--	10	uA	VR = 5V
Color Rndering Index	CRI	70/80/90	--	--		IF=20mA
Color Temperature	Tc	2700	--	7000	K	IF=20mA

## Absolute Maximum Ratings at Ta=25 °C

Parameter	Symbol	Rating	Units
Power Dissipation	Pd	90	mW
DC Forward Current	IF	20	mA
Peak Forward Current [1]	IFP	40	mA
Reverse Voltage	VR	5	V
Electrostatic Discharge (HBM)	ESD	2000	V
Operating Temperature	Topr	-40~+85	°C
Storage Temperature	Tstg	-40~+100	°C

Note:

1. 1/10 Dut cycle,0.1ms pulse width.
2. The above forward voltage measure ment allowance tolerance ±0.1V.



## Bin Range of FLUX

min	max
5	6
6	7
7	8
8	9
9	10
10	11
11	12

## Bin Range of Forward Voltage

min	max
2.8	2.9
2.9	3.0
3.0	3.1
3.1	3.2
3.2	3.3
3.3	3.4
3.4	3.5
3.5	3.6



## Typical optical characteristics curves

Ambient Temperature VS. Forward Current

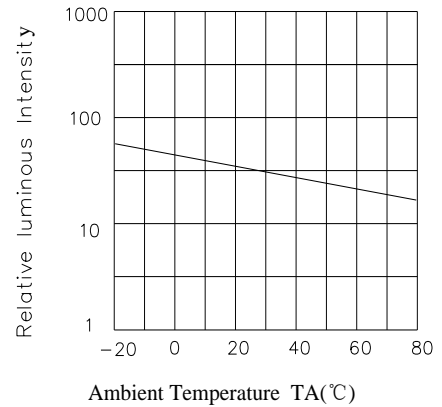
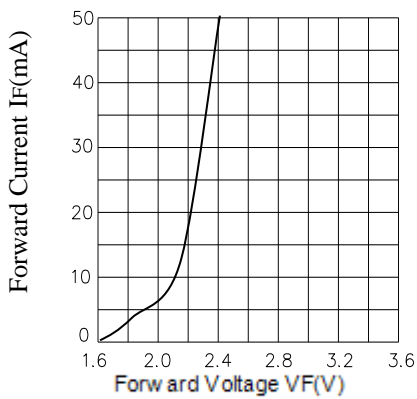
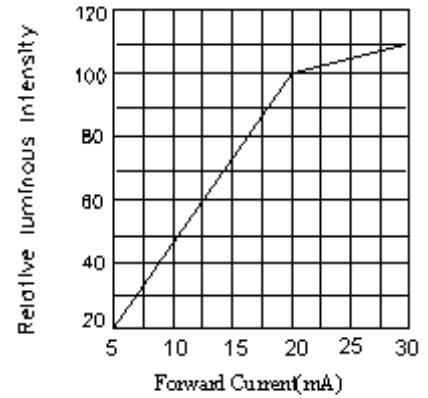
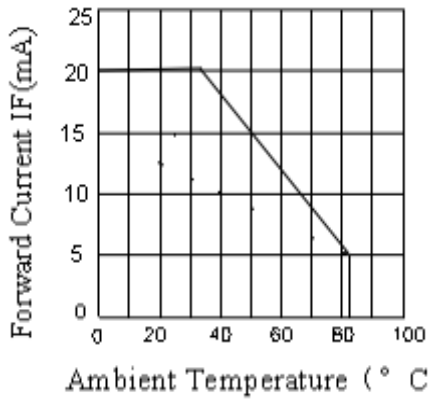

Relative luminous intensity

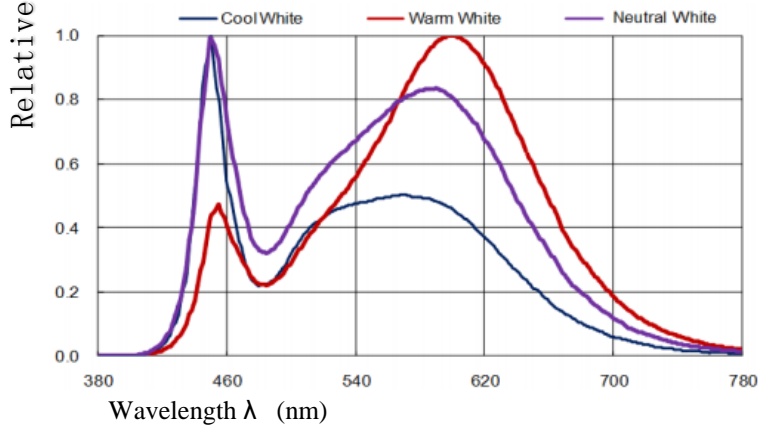

Radiation Diagram  $T_a=25^{\circ}\text{C}$

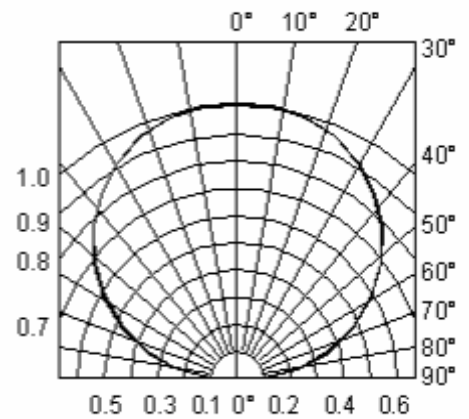



# Y. LIN ELECTRONICS CO., LTD.

## Bin Color

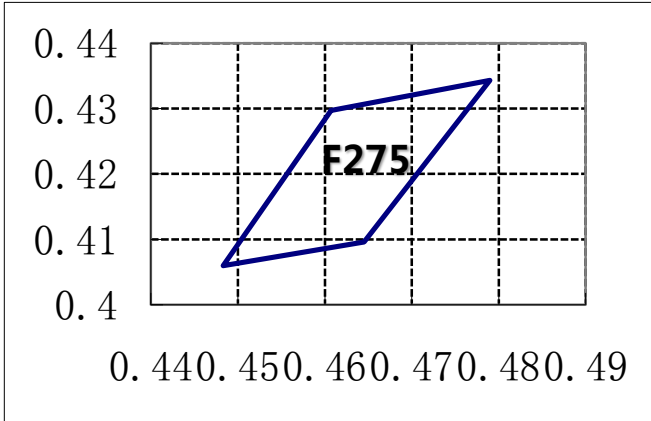

F275 2600-2800K				
x	0.4607	0.479	0.4645	0.4483
y	0.4297	0.4343	0.4096	0.406

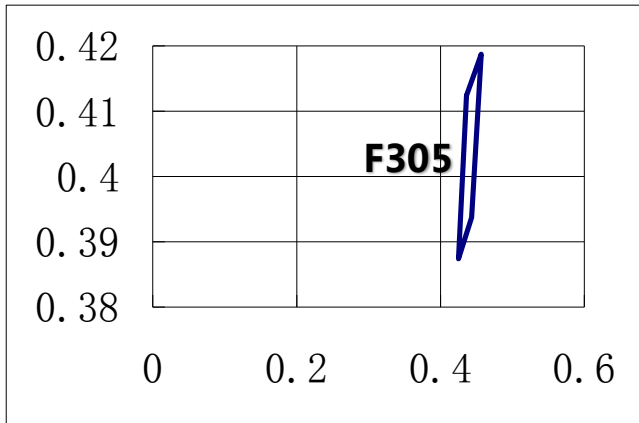

F305 2800-3100K				
x	0.4362	0.4567	0.4433	0.4248
y	0.4124	0.4187	0.3937	0.3874

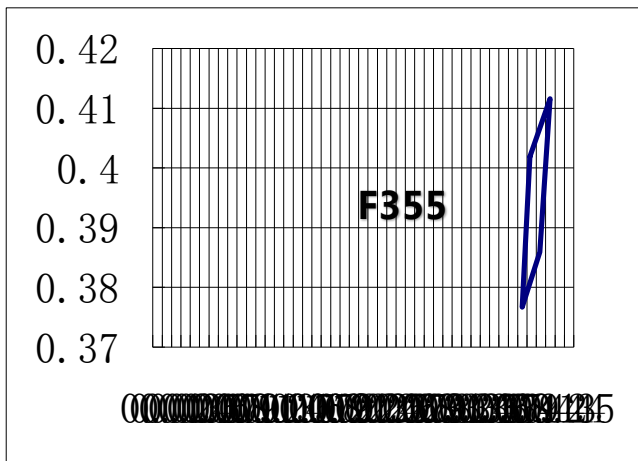

F355 3200-3600K				
x	0.4031	0.4245	0.4138	0.3947
y	0.4019	0.4116	0.3859	0.3767



# Y. LIN ELECTRONICS CO., LTD.

Bin Color

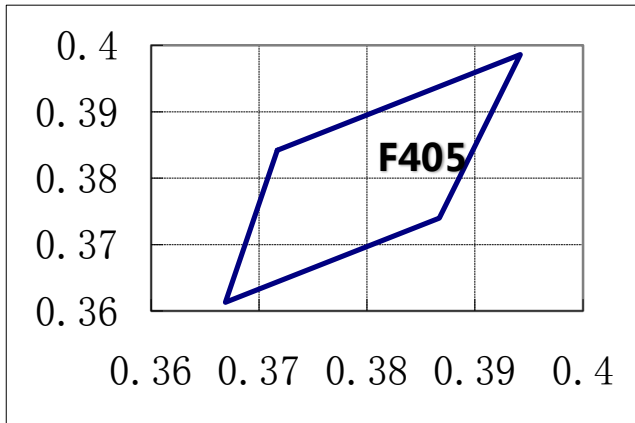

F405 3800-4250K				
x	0.3717	0.3942	0.3867	0.3669
y	0.3842	0.3986	0.374	0.3613

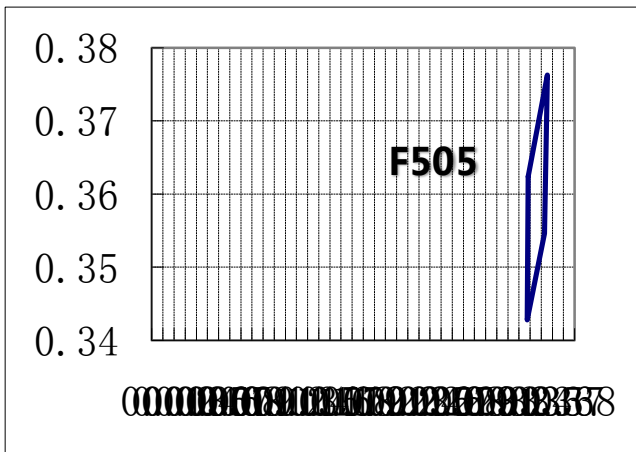

F505 4750-5300K				
x	0.3381	0.3556	0.3528	0.3375
y	0.3624	0.3763	0.3546	0.3428

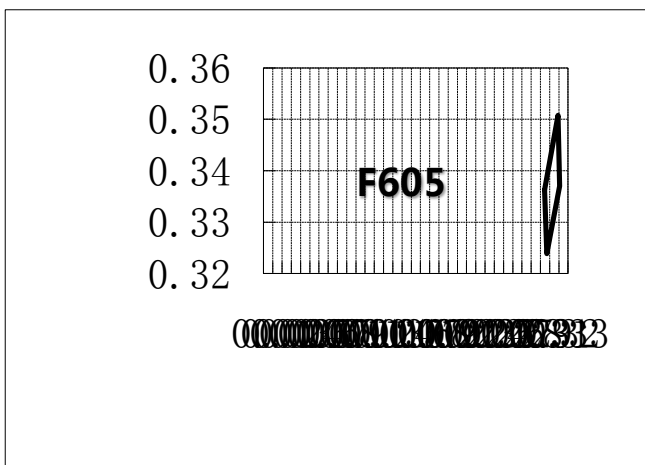

F605 6000-7000K				
x	0.3045	0.3191	0.3207	0.3069
y	0.3363	0.3508	0.337	0.3239





## Reliability Test Items And Conditions

The reliability of products shall be satisfied with items listed below.

Confidence level :90%

LTPD :10%

Test Items	Test conditions	Quantity	Judging Criteria
Solderability	Solder Temperature: 240°C Solder Duration: (3.5±0.5) sec.	22	Solderable Area Over 95%
Thermal Shock Followed by High Temperature And High Humidity Cyclic	-40°→10min 5 Cycles ↑ ↓ shift(2~3)min 100°C →10 min. 25°C~55°C (90%~95%) RH 2 Cycles for 48 hrs., Recover for 2 hrs	22	C=0 & I**
Resistance For Soldering Heat	Reflow Soldering	22	C=0 & I**
DC Operating Life	1000 hrs. Forward Current: 20mA	22	C=0 & I**
High Temperature Storage	100°C → 1000 hrs	22	C=0 & I**
High Temperature And High Humidity Cyclic	25°C~55°C (90%~95%) RH 6 Cycles for 144 hrs., Recover for 2 hrs.	22	C=0 & I**

The technical information shown in the data sheets are limited to the typical characteristics and circuit examples of the referenced products. It does not constitute the warranting of industrial property nor the granting of any license.



## SMT Reflow Soldering Instructions

1. Reflow soldering should not exceed once.
2. In soldering process, do not stress on the LEDs during heating.

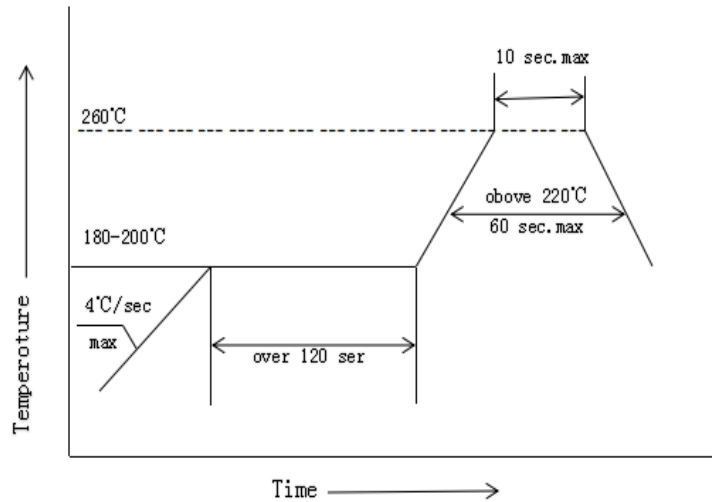

## Soldering iron

1. When hand soldering, the temperature of the iron must be lower than 300°C for 3 seconds.
2. The hand solder should be done only one time.

## Repairing

Repair should not be done after the LEDs have been soldered. When repairing is unavoidable, a double-head soldering iron should be used (as below figure). It should be confirmed beforehand whether the characteristics of LEDs will or will not be damaged by repairing.

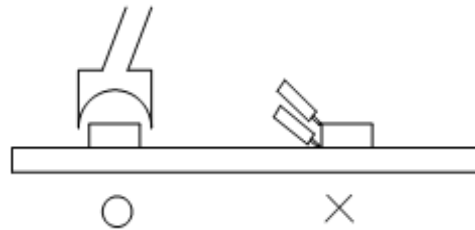

## Storage

The package is sealed:

1. Recommended storage condition: At 5°C~30°C and relative humidity 90% RH max.
2. It is recommended that SMD out of their original packaging are used within one year.

The package is opened:

1. Completed within 168 hours.
2. Stored at 5°C~30°C and 60% RH or less.
3. LEDs stored more than 168 hours should be baked at about 65°C±5°C for at least 12 hours before solder assembly.

## Handling Precautions

1. Do not stack together assembled PCBs containing LEDs. Impact may scratch the silicone lens or damage.

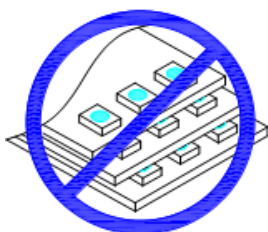

2. Not available in the situation of acidity for PH.





Carrier tape (MPQ:2000PCS/reel)

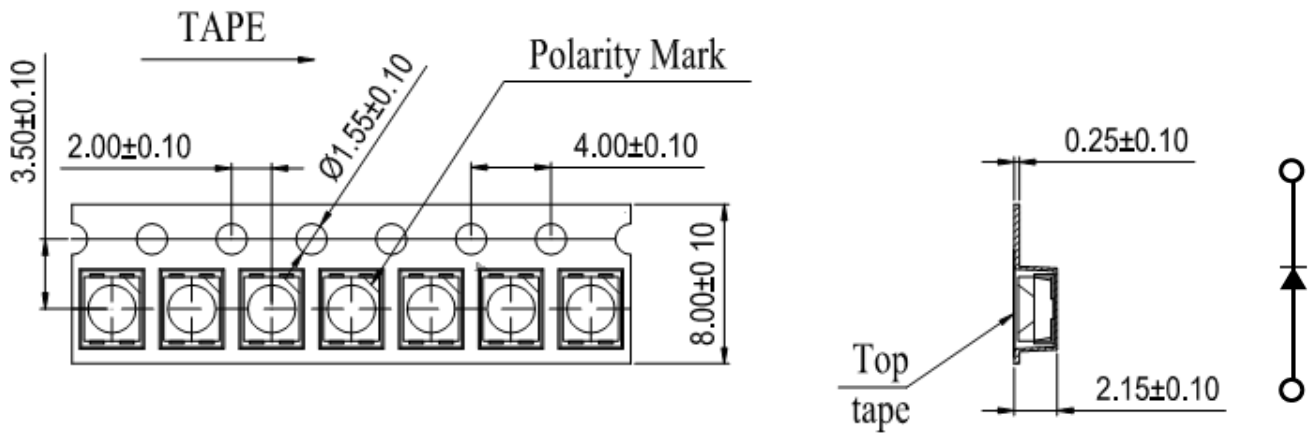

All dimensions in mm, tolerances unless mentioned is  $\pm 0.1$  mm.

### Moisture Resistant Packaging

