

产品说明

PRODUCT DESCRIPTION

- 规格: 1508x773x523
- 产品材料: 人造石
- 满水容量为245升
- Dimensions: 1508x773x523
- Material: Solid Surface Bathtubs
- Full water volume is 245L

A 安装尺寸图
INSTALLATION DIMENSION

单位: mm
Unit: mm

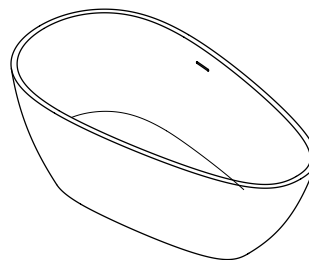
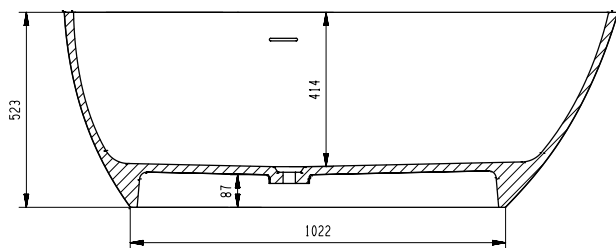
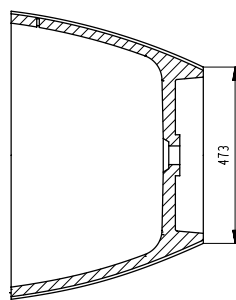
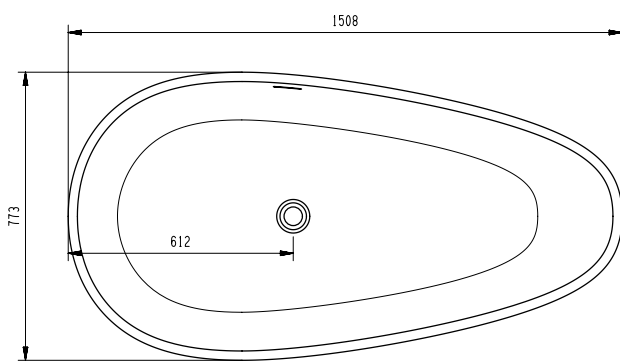

B 备用工具 HELPFUL TOOLS

扳手
Adjustable Wrench



墨斗与铅笔
Marking Gauge and Pencil



卷尺
Tape Measure



防霉中性硅胶
Neutral Mildew Resistant
Silicone Sealant



水平尺
Level

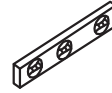

防护眼镜
Safety Glasses



C 安装注意事项 POINTS FOR ATTENTION BEFORE INSTALLATION

- 1、为了方便运输和防止运输造成的损坏，每一只浴缸均包装在纸箱内。但是，为了保证产品的质量，请您在安装前仔细检查产品的质量。如在安装后再提出与以下内容有关的质量问题，这并不包括在我们的责任范围内。
- 2、安装前，请仔细阅读本手册，并正确施工。
- 3、请按本说明书内记载的方法施工。擅自变更施工方法所引起的不良后果，本公司将不负责所引起之损失。
- 4、需请专业人员施工。

检查

- (1) 在您收到浴缸打开包装箱后，检查所有的配件是否完好。
- (2) 请检查浴缸表面是否有任何撞击或破损的现象。
- (3) 请检查管道口是否紧密牢固。
- (4) 在正式安装前，请检查是否因运输造成浴缸漏水。检查所有的接口和配件是否漏水，渗水。

安装注意事项

- (1) 我们建议您为了方便维修和清洁，请将浴缸安装在瓷砖已经贴好的台面和地砖已经贴好的地坪上。
- (2) 为了便于安装和检修浴缸的排水系统，请不要将浴缸用水泥及瓷砖将其封死。
- (3) 搬运浴缸时，严禁提拉管道或将管道作为提手。
- (4) 将墙，地砖的工程完全结束后，再将浴缸从包装箱中取出进行安装。
- (5) 施工时，严禁将灯泡，明火置于浴缸内。
- (6) 施工时，严禁在浴缸内存放黄沙，水泥及其它容易损坏缸体表面的杂物。
- (7) 施工时，严禁向浴缸内倾倒油漆，胶水等溶剂。

1. To facilitate transportation and protect product from damage that may occur in delivery, each bathtub is packed in cartons. In order to avoid quality dispute, please kindly check product before installation. Or Sunshine should not be liable for any quality issue raised after installation.
2. Please read the instruction carefully before beginning to install.
3. Please follow steps in the instruction to install this product or may result in costly mistake. Sunshine shall not be responsible for any loss from that mistake.
4. Professional help is required for installation of this product.

Inspection

- (1) Check and ensure all accessories are in good condition.
- (2) Check and ensure bathtub surface is free of hit and damage.
- (3) Check and ensure pipe connection is firm and compact.
- (4) Before starting installation, check and ensure bathtub, all connections and accessories are free of leaks that may occur during delivery.

Attention points at Installation

- (1) To facilitate maintenance and clean, we recommend to install bathtub on finished floor with ceramic tile or terrace with ground tile.
- (2) To facilitate the installation and maintenance of the drainage system, do not block the bathtub with cement or ceramic tiles.
- (3) DON'T lift pipes or use pipes as lift when transport bathtub.
- (4) DON'T take bathtub out of package for installation until wall and floor preparation finished.
- (5) NO bulbs and open fires are allowed to place in bathtub during installation.
- (6) NO stuff like sand, cement or other sundries are allowed to place in bathtub as that would likely damage bathtub surface.
- (7) NO solvent like paint or glue are allowed to contact with bathtub.

D 安装步骤 INSTALLATION STEP

1

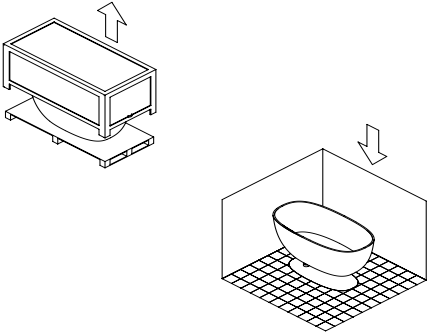

安装施工前, 请在地面上布施下水管道, 冷热进水管。冷热水管的尺寸, 请按具体施工时浴缸边缘距墙面的距离、确定。

Before installation, please lay water pipes, cold and hot water inlet pipes on the ground. The dimension of cold and hot conduit should be decided according to the distance of bath crock brim and metope when specific construction.

2

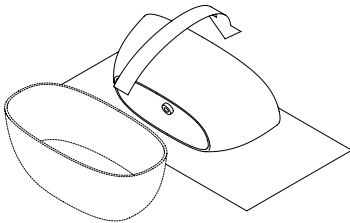

将浴缸放在合适的位置
用软质板料垫在浴缸的
侧翻面地上, 防止碰伤。

Position the tub in place and pad the side of the tub with a soft material to prevent chafing.

注意: 浴缸必须水平安装。底层地板必须水平。不得有凹凸不平的现象。

IMPORTANT:
The bathtub must be installed level. Floor should be flat, level and free of any bumps or protrusions.

3

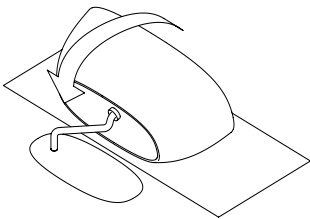

安装排水管

将浴缸放到安装位置适当倾斜缸体把底部排水管插入预留好的下水孔内, 下水孔应离浴缸排水阀200-300mm。

Installing the drain

Put the bathtub on the installation location. Tilt the bathtub properly and drain pipe at the bottom should be inserted into preformed drain hole which should be 200-300mm away from drainage valves.

4

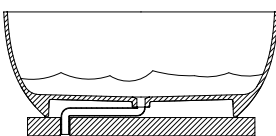

完工清理

在安装完成后小心去除产品保护膜; 进行清理时, 请勿使用磨损性的清洁用具。最后在浴缸外底部与地面连接处用中性玻璃胶均匀的填上一圈待固化使浴缸定位。

Cleaning after complete installation

When installation is completed, remove the protective film from the product with caution; do not use abrasive cleaning tools to clean. At last, between the exterior bottom of bathtub and the ground, use neuter glass glue to evenly seal round and the bathtub will be fixed after solidification.

E 维护与保养 MAINTENANCE

- 1、为使浴缸干净整洁，建议在沐浴后，趁水刚放完而浴缸还没干的时候立即清洁浴缸，这时候很容易将肥皂、人体脂肪及污垢等清除，以免污垢粘在浴缸上干结后不便清洁。
- 2、在水质较硬的地区，由于水中钙的含量高，污垢粘在浴缸壁上会留下黄色的斑痕，所以请您经常清洁浴缸。
- 3、清洁时，使用柔软的布配以中性清洁剂或肥皂水清洗，然后将水份擦干。
- 4、严禁使用尖硬的物品或具有研磨作用的物品如去污粉等，清洁浴缸及护罩表面，因其可能腐蚀、划伤浴缸表面，从而降低表面光泽。
- 5、树脂浴缸可以抵御绝大多数常用家用化学品的侵蚀，但仍应避免与油漆，油漆清除剂如氯仿和丙酮等强有机溶剂接触。如果它们与浴缸表面接触，将可能引起表面软化，溶化或龟裂。
- 6、严禁将燃着的烟头放在浴缸表面上，否则将留下燃烧的疤痕。
- 7、严禁将灯泡，明火放置在浴缸内，以免造成表面破损。

以下是对划伤的的建议：

- (1) 如果浴缸表面有轻微的划伤或擦痕，可在划伤处喷上金属抛光剂或汽车抛光剂，用电动抛光机磨抛来重新获得光亮表面。
- (2) 如果是较深的划伤，可先使用2000 #水砂纸擦去划痕，然后用上述的方法来获得光亮表面。

F 特别申明 SPECIAL STATEMENT

本产品说明书是根据最新产品资料编写而成，本公司遵循可持续发展策略，对产品的规格、性能等进行持续的改进，如有变更，恕不另行通知。（本公司保留此项解释权）

1. Suggest to clean bathtub immediately after drainage complete, as soap, body fat and dirt are easy to be removed at the time before bathtub dry.
- 2.Suggest to clean bathtub frequently if using in high hard water area, where high calcium content in water would leave yellow spot after dirt attaching on bathtub surface.
- 3.Please use soft cloth with neutral cleaner or soap to clean bathtub, and then wipe its surface to dry.
- 4.No hard stuff or abrasive stuff like cleaning powder are allowed to clean bathtub, as that would corrode, scratch and dull bathtub surface.
5. Do not allow paint, paint remover like chloroform or any strong organic solvent like acetone in contact with any bath surfaces,or bathtub surface would be softened, melted or crackle.
6. Do not place flaming cigarette on bath or it would burn bathtub surface.
- 7.NO bulbs and open fires are allowed to place in bathtub lest bathtub surface is damaged.

Suggestion to remove scratch:

- (1) If scratch is slight, spray metal polish or car polish on scratch at first,and then use electric polishing machine to resume glossy surface.
- (2) If scratch is deep, use 2000# abrasive paper to remove scratch at first, and then use same method as (1) to resume glossy surface.

The products installation instruction is written in accordance with the latest product information, following the sustainable development strategy of the Company, to improve continually the produce's specification, performance etc.,subject to change without notice. (The Company reserves the right to interpret)