

Features

- 150 Watts Peak Pulse Power per Line (tp = 8/20μs)
Bidirectional Configuration
- Protects One Power or I/O Port
- ESD Protection > 40 kilovolts
- Low Clamping Voltages
- Ultra Low Capacitance: 7 pF Typical
- AEC-Q101 Qualified



SOD-523

IEC Compatibility (EN61000-4)

- IEC 61000-4-2 (ESD) :±15kV (air), ±8kV (contact)
- IEC 61000-4-4 (EFT) :40A (5/50ns)
- IEC 61000-4-5(Surge): 10A, 8/20μs

Applications

- Ethernet - 10/100/1000 Base T
- Cellular Phones
- Handheld - Wireless Systems
- Personal Digital Assistant (PDA)
- USB Interface

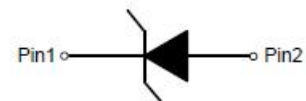

Circuit diagram

Electrical Parameters

Parameter	Symbol	Value	Units
Peak pulse power (tp=8/20us)	P _{PP}	150	Watts
Operating Temperature	T _J	-55°C~125°C	°C
Storage Temperature	T _{STG}	-55°C~150°C	°C

Symbol	Parameter
I _{PP}	Maximum Reverse Peak Pulse Current
V _C	Clamping Voltage @ I _{PP}
V _{RWM}	Working Peak Reverse Voltage
I _R	Maximum Reverse Leakage Current @ V _{RWM}
V _{BR}	Breakdown Voltage @ I _T
I _T	Test Current
I _F	Forward Current
V _F	Forward Voltage @ I _F

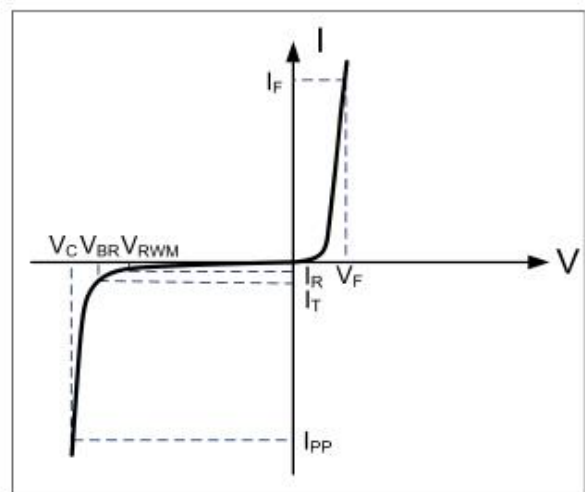

Ratings and characteristic curves (T_A=25°C unless otherwise noted)

Parameter	Symbol	Condition	Min	Max	Units
Reverse Stand-off Voltage	V _{RWM}	Pin2 to 1/Pin1 to 2		3.3	V
Reverse Breakdown Voltage	V _{BR} (min)	I _Z =1mA	4.0		V
Reverse Leakage Current	I _R (max)	@V _{RWM}		0.2	μA
Clamping Voltage	V _C	I _{PP} =10A tp=8/20us		15	V
Junction Capacitance	C _{I/O}	Pin capacitance to GND.Vdc=0V,f=1MHZ	100		pF

Typical Characteristics

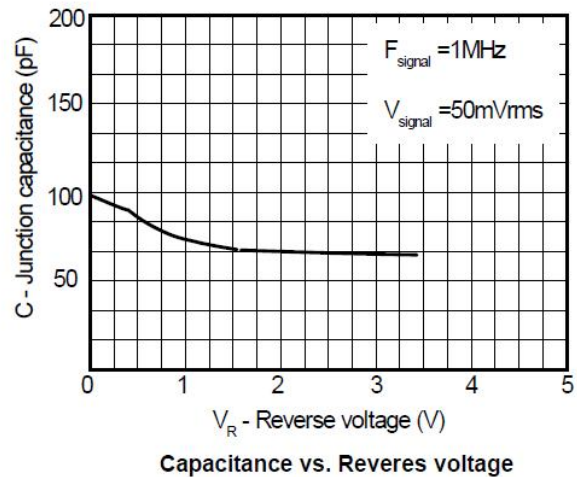
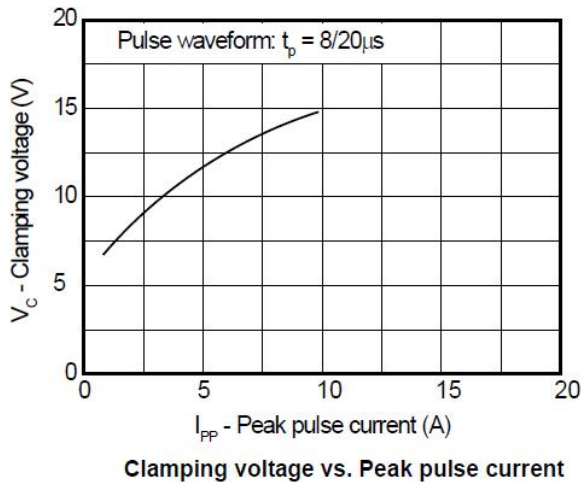
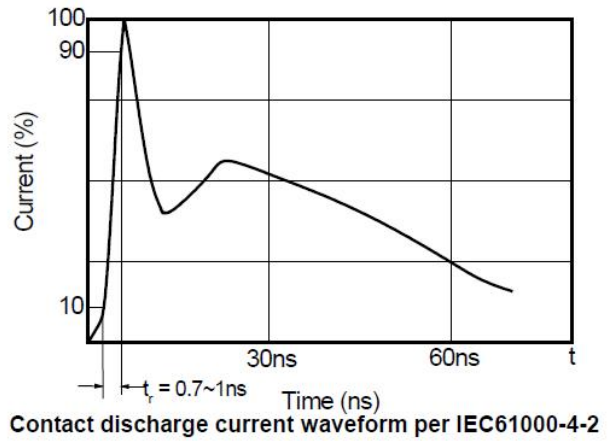
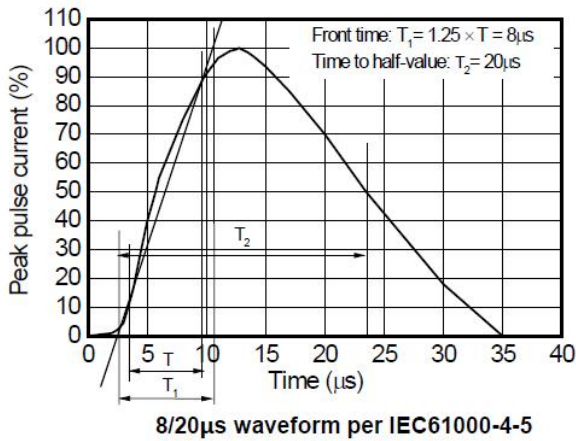

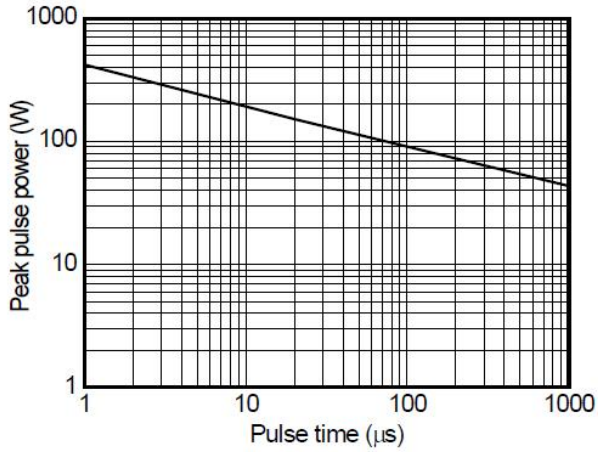

Non-repetitive peak pulse power vs. Pulse time

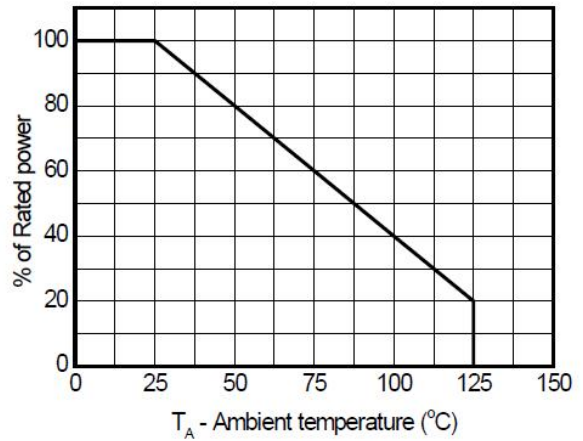

Power derating vs. Ambient temperature

Dimensions

SOD-523

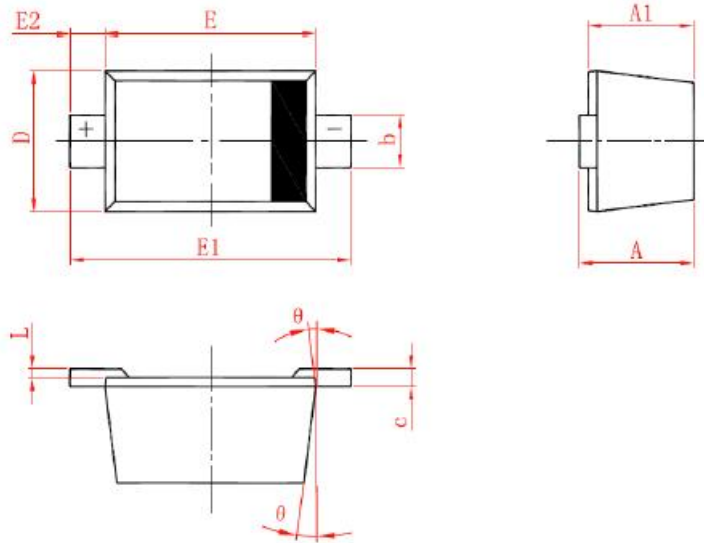

Symbol	Dimensions in millimeter		
	Min.	Typ.	Max.
A	0.510	0.640	0.770
A1	0.500	0.600	0.700
b	0.250	0.300	0.350
c	0.080	0.115	0.150
D	0.750	0.800	0.850
E	1.100	1.200	1.300
E1	1.500	1.600	1.700
E2	0.200 Ref		
L	0.010	0.040	0.070
θ	7° Ref		