

规格承认书

规格书编号

J.SPC.50.13-013

品名

New 3X6 Non Pilot

型号

THBM03-LB-R

7/10

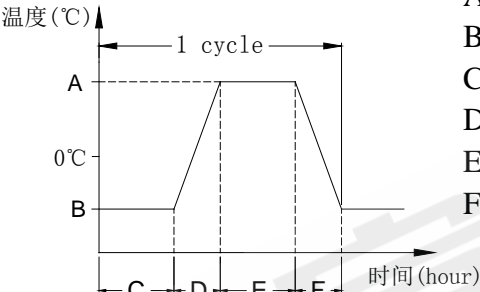
Item 项目	Test Condition 测试条件	Requirements 要求
<p>6.3.5</p> <p>Change of Temperature 温度循环</p>	<p>Following ten cycles of high temperature test .The Sample shall be Placed in Normal temperature and humidity Conditions for one hour before measurements are made. During this test, water drops shall be removed.</p> <p>样品按下列条件进行高低温循环试验,试验后在正常温度和湿度条件下放置 1 小时后测定</p> <div style="text-align: center;">  <p>温度(°C)</p> <p>时间(hour)</p> </div> <p>A: +85±2°C B: -40±2°C C: 2 小时 D: 1 小时 E: 2 小时 F: 1 小时</p> <p>Cycling: Five cycles 周期: 5 次</p>	<p>Contact resistance: 200 mΩ Max. 接触电阻</p> <p>Insulation resistance : 50 MΩ Min. 绝缘电阻</p> <p>Item 6.1.3、6.1.4 Item 6. 2.1~6.2.3</p>
<p>6.3.6</p> <p>Salt Spray Test 盐雾试验</p>	<p>The salt spray test shall be conducted at the following conditions : 样品按下列条件进行盐雾试验</p> <p>(1)Density(浓度): 溶液(5±1)% Nacl (质量百分比)</p> <p>(2)Temperature: 35±2°C 温度</p> <p>(3) Time: 24 hours 时间</p>	<p>金属件无发黄、生锈</p>
<p>6.3.7</p> <p>Vibration Resistance 耐振动</p>	<p>Measurements shall be made following the test set forth below: 按下列条件进行抗振动试验</p> <p>(1)Range of oscillation:10 to 55Hz 频率范围</p> <p>(2)Amplitude,pk-to-pk:1.5 mm 振幅: 峰-峰 1.5mm</p> <p>(3)Cycle of sweep: 10-55-10Hz in one minute, approx.扫描周期: 10-55-10Hz 约一分钟内</p> <p>(4)Mode of sweep: Logarithmically sweep or uniform sweep. 扫描方式:对数扫描式恒定扫描</p> <p>(5)Direction of oscillation: 振动方向</p> <p>Three mutually perpendicular directions, including the direction of stem travel. 3 个相互垂直方向,包括推柄行程方向</p> <p>(6)2 hours each ,for a total of 6hours.每方向 2 小时,共 6 小时</p>	<p>Item 6.1 Item 6. 2.1、6.2.2</p>

规格承认书

规格书编号
J.SPC.50.13-013

品名

New 3X6 Non Pilot

型号

THBM03-LB-R

8/10

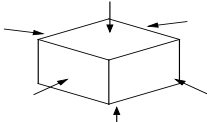
Item 项目	Test Condition 测试条件	Requirements 要求
6.3.8	<p>Impact Shock Resistance 抗冲击</p> <p>Measurements shall be made following the test set forth below: 按下列条件进行冲击试验</p> <p>(1)Acceleration:80g 加速度</p> <p>(2)Cycles of test :3 cycles each in 6directions, for a total of 18cycles 试验次数:每个方向3次,6个方向共18次</p> 	<p>Item 6.1</p> <p>Item 6. 2.1、6.2.2</p>

7. 焊接条件:

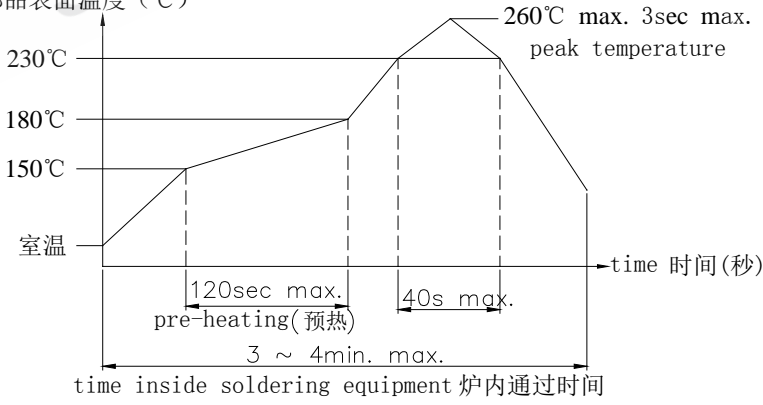
Item 项目	Recommended conditions 推荐条件
7.1	<p>Hand soldering 手工焊接</p> <p>Please practice according to bellow conditions:</p> <p>(1)Soldering temperature :$\leq 350^{\circ}\text{C}$</p> <p>(2)Continuous soldering time:$\leq 3\text{ S}$</p> <p>(3)Capacity of soldering iron:$\leq 60\text{ W}$</p> <p>请按以下条件进行焊接:</p> <p>1)焊锡温度: $\leq 350^{\circ}\text{C}$</p> <p>(2)连续焊接时间: $\leq 3\text{ S}$</p> <p>(3)电烙铁的功率: $\leq 60\text{ W}$</p>
7.2	<p>Automatic flow soldering 自动焊接</p> <p>For the product of SMT , type solder according to the following conditions 对于 SMT 产品, 请按以下条件进行焊接</p> <p>surface of product temperature 部品表面温度 ($^{\circ}\text{C}$)</p>  <p>time inside soldering equipment 炉内通过时间</p> <p>Caution: the condition mentioned above is a temperature on the PWB surface on which parts are mounted. There are cases where PWB temperature greatly differs from switch's surface temperature depending on PWB material, size, thickness, etc. The switch's surface temperature shall not allowed to exceed 260°C 注意: 以上提及的条件是零部件上 PWB 表面的温度, 由于 PWB 的材料、尺寸、厚度等不同, PWB 从开关表面获得的温度也会有很大产不同, 因此, 千万小心不要让开关表面温度超过 260°C</p>

规格承认书

规格书编号
J.SPC.50.13-013

品名

New 3X6 Non Pilot

型号

THBM03-LB-R

9/10

8. Other precautions 其他注意事项:

- (1) Following the soldering process, do not try to clean the switch with a solvent or the like.
进行焊接过程中，不可以用溶剂或类似品清洗开关
- (2) Safeguard the switch assembly against flux penetration from its topside.
防止助焊剂从开关的顶端渗入
- (3) Please have the products keep in close status and the storage time is 90 days guaranty after delivering the goods at most.
交货后保证开关处于封密状态并库存时间 90 天以下

9. REEL PACKAGING 盘装

9.1 Scope 范围

This specification covers the requirements of the reel packaging for SMT standard type of tact switches. 该规范包含 SMT 标准型拨动开关的绕带封装的要求

9.2 Packaging Materials 封装材料

Item	项目	Description	说明
Package	包装	Cartons	卡通箱
Reel	转轴	Delete Cartons	可降解箱
Carrier Tape	载带	Polypropylene	聚丙烯

9.3 Packaging Quantity 封装数量

9.3.1 The number of the reels. 转轴数量

Twenty (20) reels at maximum. Which contain 40K pcs switches
Shall be packed in a package. 一箱装 20 盘,有 40K 只产品

9.3.2 The number of the switches. 产品数量

2K pcs switches shall be packed in a reel. 一个转轴包 2K 只产品

9.3.3 It should be noted that we regard two cartons 对出口包装需注意用两个箱子包装 mentioned above as on package for export.

*** THE DIMENSION OF CARRIER TAPE, COVER TAPE AND REEL ***

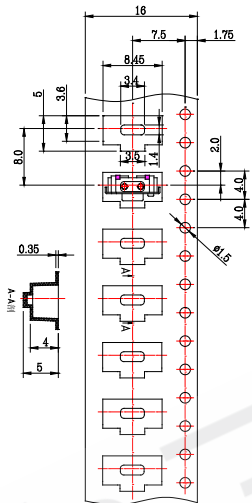

MODEL NAME	CODE NO.
THBM03	

*** THE SPECIFICATION FOR PACKAGING ***

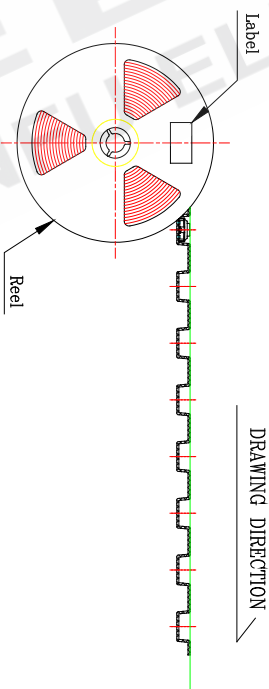
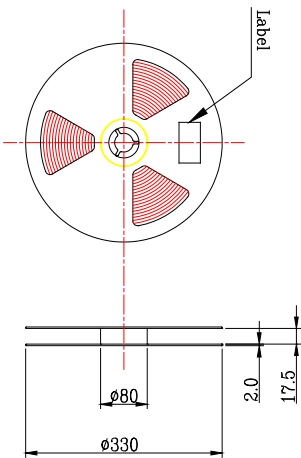
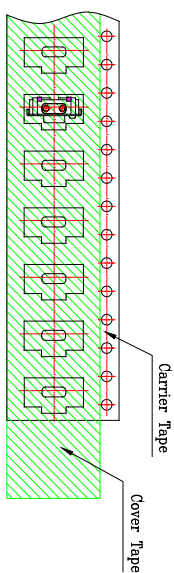

*** END TAPE ***

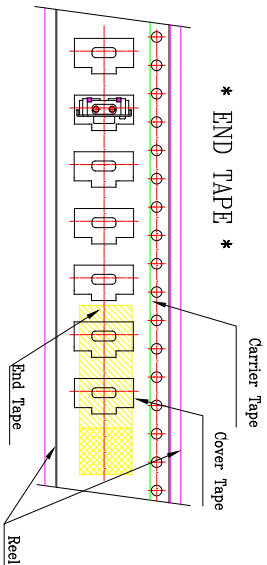

End

*** THE SPECIFICATION FOR PACKAGING ***

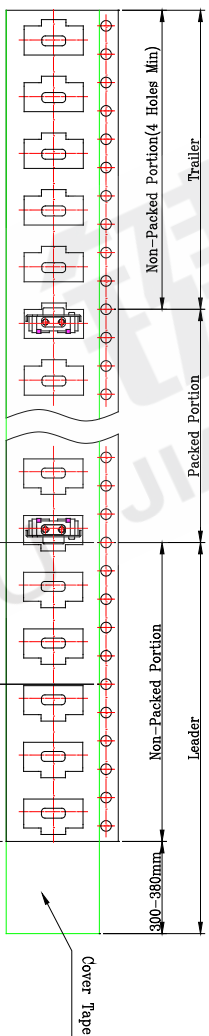

Start

- NOTE**
1. 2K pcs SWITCHES PER 1 REEL
 2. GENERAL TOLERANCE : 0.3mm

REFERENCE DRAWING

Designed by		Unit	浙江健富电子有限公司	
Checked by		Scale	ZHEJIANG JIANGFU ELECTRONICS CO., LTD	
Approved by		N/S	Date	2011.10.14
Item	TACTILE SWITCH	Tool	Sheet	1/1
Model	New 3X6 Pilot φ 0.8	Drawing name	ASSEMBLY	

RevNo	Revision note	Date	Signature