

Note:

- Material:
  - Housing: thermoplastic high temp.UL94V-0;
  - Latch: thermoplastic high temp.UL94V-0;
  - Terminal: copper alloy.
  - Fitting Nail: copper alloy.
- Finish:
  - Terminal: Underplating: Au/matt Tin overall.
  - Fitting Nail: Underplating: matt Tin overall.
- Product must comply HF RoHS specification.
- Product No:
 

AFA07-S	**	F	*	* - **
CKTS				
CONTACTS TYPE				
F:Lower				

PLATING

- Gold flash 1u"
- Gold flash 2u"
- Gold flash 3u"

B:Bright-Tin 90-120u"  
C:Matt-Tin 90-120u"

REMARKS  
HF:Halogen free  
Housing White,Latch Black  
3F:Halogen free(Without Zy)  
Housing White,Latch White

PACKING  
A:Tape&Reel  
C:Tube

CKTS	DIM A	DIM B	DIM C	DIM D
4	3.00	5.10	9.05	11.00
5	4.00	6.10	10.05	12.00
6	5.00	7.10	11.05	13.00
7	6.00	8.10	12.05	14.00
8	7.00	9.10	13.05	15.00
9	8.00	10.10	14.05	16.00
10	9.00	11.10	15.05	17.00
11	10.00	12.10	16.05	18.00
12	11.00	13.10	17.05	19.00
13	12.00	14.10	18.05	20.00
14	13.00	15.10	19.05	21.00
15	14.00	16.10	20.05	22.00
16	15.00	17.10	21.05	23.00
17	16.00	18.10	22.05	24.00
18	17.00	19.10	23.05	25.00
19	18.00	20.10	24.05	26.00
20	19.00	21.10	25.05	27.00
21	20.00	22.10	26.05	28.00
22	21.00	23.10	27.05	29.00
23	22.00	24.10	28.05	30.00
24	23.00	25.10	29.05	31.00
25	24.00	26.10	30.05	32.00
26	25.00	27.10	31.05	33.00
27	26.00	28.10	32.05	34.00
28	27.00	29.10	33.05	35.00
29	28.00	30.10	34.05	36.00
30	29.00	31.10	35.05	37.00

CUSTOMER DRAWING

深圳扬讯电子有限公司

Product Name(产品名称): 1.0Pitch H=2.5 FPC/FFC ZIF R/A TypeK1 Lower SMT CONN

Product No(产品料号): AFA07-S\*\*F\*\*\*

Design(设计): Allan

Checked(审核):

Approved(核准):

Tolerance Unspecified (未注公差)	Size(规格): A4
0.0 ±0.25 0° ±5°	Unit(单位): MM
0.00 ±0.15 0°0 ±3°	Scale(比例): 1:1
0.000 ±0.10 0°00 ±1°	Page(页数): 1 OF 1
Project View (投影视角)	Rev(版本): A

Rev 版本	Change Description 变更内容	Date 日期	Revisor 制修订人
A	初版发行	2011/03/23	Allan

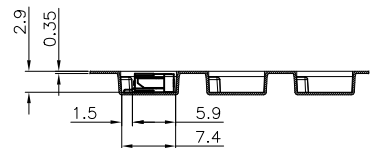
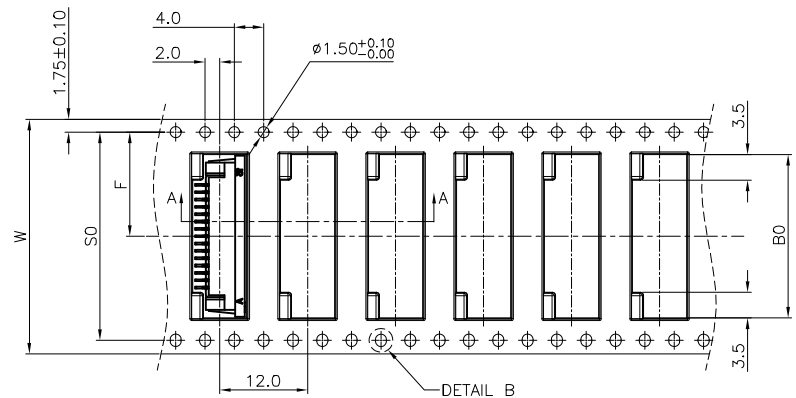
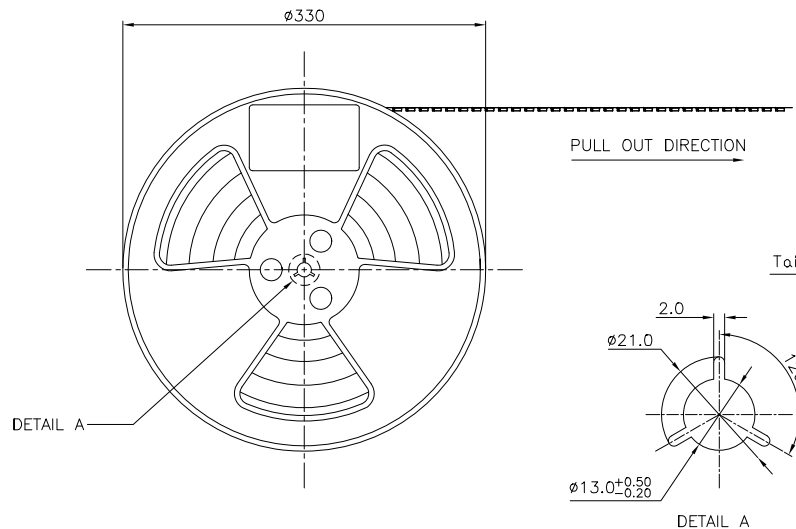
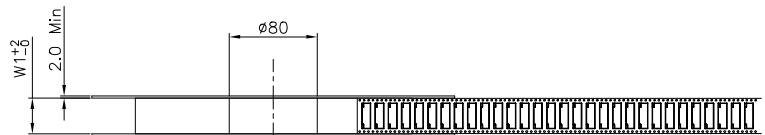

SECTION A-A  
SCALE 1:1

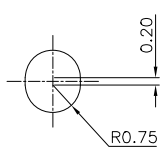

DETAIL B  
SCALE 5:1

NOTES:

1. 10 SPROCKET HOLE PITCH CUMULATIVE TOLERANCE.±0.20mm
2. CARRIER CAMBER NOT TO EXCEED 1mm IN 250mm.
3. ALL DIMENSIONS MEET EIA-481-C REQUIREMENTS.
4. MATERIAL: BLACK ANTI-STATIC POLYSTYRENE.
5. THICKNESS: 0.35 ± 0.05 mm.
6. PACKING LENGTH PER 13" REEL : 18.60METERS.
7. COMPONENT LOAD PER 13" REEL : 1500PCS
8. PEELING OFF FORCE OF TOP TAPE 0.1N~0.7N(10.2gf~71.4gf).

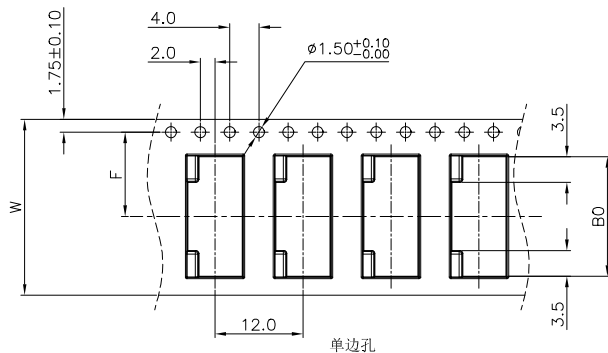
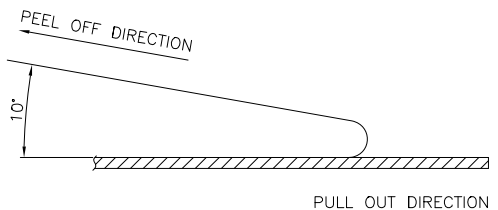
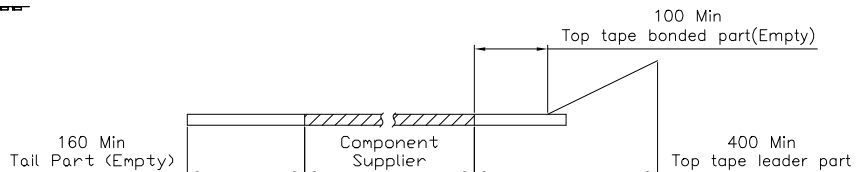

CKTS	B0±0.10	W	W1	F	S0±0.10
4	11.30	24+0.3/-0	24.4	11.5±0.10	单边孔
5	12.30				
6	13.30				
7	14.30				
8	15.30	32±0.30	32.4	14.2±0.10	28.4
9	16.30				
10	17.30				
11	18.30				
12	19.30	44±0.30	44.4	20.2±0.15	40.4
13	20.30				
14	21.30				
15	22.30				
16	23.30	56±0.30	56.4	26.2±0.15	52.4
17	24.30				
18	25.30				
19	26.30				
20	27.30	56±0.30	56.4	26.2±0.15	52.4
21	28.30				
22	29.30				
23	30.30				
24	31.30	56±0.30	56.4	26.2±0.15	52.4
25	32.30				
26	33.30				
27	34.30				
28	35.30	56±0.30	56.4	26.2±0.15	52.4
29	36.30				
30	37.30				

CLASSIFICATION DIMENSION (尺寸类别):  
 FAI (首次检验): ⊙To ⊙  
 ■ MARK IS MAJOR DIM (重点尺寸标示)  
 \* ⊙ MARK IS CRITICAL DIM (Cpk&Cp 标示)

Tolerance Unspecified (未注公差)	Size (图幅): A4
0.0 ±0.10 0° ±3°	Unit (单位): MM
0.00 ±0.05 0° 0 ±2°	Scale (比例): 1:1
0.000 ±0.02 0° 00 ±1°	Page (页数): 10 OF 10
Project View (投影视角)	Rev (版本): 1.0

# 深圳扬讯电子有限公司

Product Name (产品名称): 1.0Pitch H=2.5 FPC/FCC 拉拔卧式K型 载带		
Product No (产品料号): EB-740XXX290-00		
Drawing No (图面编号): DNE00015-1	Date (日期): 2011/04/09	
Designer (设计): Allan	Checked (审核):	Approved (核准):

1.0	初版发行	2011/04/09	Allan
Rev 版本	Change Description 变更内容	Date 日期	Revisor 制/修订人

