OPERATION MANUAL

TH2690

TH2690 Electrometer/High Resistance Meter

Tonghui Electronic Co.,Ltd.

www.tonghui.com.cn

Contents

Chapte 1 Overview	1
1.1 Tonghui TH2690 Series	1
1.2 Inspecting the Shipment	2
1.3 Operating Conditions	2
1.3.1 Power \swarrow	2
1.3.2 Environmental Conditions	3
1.3.3 Preheating	3
1.4 Checking the Operation of TH2690	3
1.5 Checking for Errors	3
Chapter 2 Points for notice	5
2.1 Safety Precautions	5
2.1.1 Power Supply and Measurement Safety	7
2.1.2 High Voltage Shock Hazard	7
2.1.3 Insulation Resistance	8
2.1.4 Dielectric Strength	8
2.1.5 Leakage Current	9
2.2 Electromagnetic compatibility	9
Chapter 3 Introduction to panels	10
3.1 Introduction to the Front Panel	10
3.2 Introduction to the rear panel	14
Chapter 4 Operation Instructions	17
4.1 Home Screen Introduction	17
4.2 Measurement Settings	18
4.2.1 Ammeter Settings	18
4.2.2 Voltmeter Settings	20
4.2.3 High Resistance Meter	21
4.2.4 Electro Meter Settings	23
4.2.5 Voltage Source Settings	25
4.3 Configuration Settings	26
4.3.1 Filter	26
4.3.2 MATH	27
4.4 Wave Form Settings	28
4.4.1 Graph	28
4.4.2 Histogram	30
4.5 BIN Settings	30
4.6 Source Setting	32
4.6.1 Linear Single (LinearS)	32
4.6.2 Linear Double (LinearD)	33
4.6.3 Square Waveform Output (ARB Squ)	34
4.6.4 List	35
4.7 Environment System	35
4.8 BUS System	37
4.8.1 RS232	38
4.8.2 LAN	39

4.8.3	USB	39
4.9	SetSys	40
4.10	Handler	41
4.11	File	42
4.12	Tool	43
Chapter 5	Instrument Measurements and Instructions	45
5.1	Current Measurement	45
5.1.1	Requirements	45
5.1.2	Procedure.....	47
5.1.3	Setup Parameters	48
5.1.4	Common Terminal Connection	48
5.2	Voltage Measurement.....	50
5.2.1	Requirements.....	50
5.2.2	Procedure.....	52
5.2.3	Setup Parameters	53
5.2.4	Guarded and Unguarded Connections	53
5.2.5	Guarding.....	54
5.3	Resistance Measurement	56
5.3.1	Requirements	56
5.3.2	Procedure.....	58
5.3.3	Resistance Calculation Mode.....	59
5.3.4	Choosing Range for High Resistance Meter.....	59
5.3.5	Low Terminal State.....	60
5.4	Charge Measurement.....	60
5.4.1	Requirements	61
5.4.2	Procedure.....	62
5.4.3	About Charge Measurement	63
5.4.4	Automatic Discharge	63
5.4.5	Discharge Level.....	63
5.5	Voltage Source.....	63
5.5.1	Procedure.....	64
5.6	Temperature and Humidity Measurement.....	65
5.6.1	Requirement.....	65
5.6.2	Preparation for connecting humidity sensor	65
5.7	Installing the Interlock Circuit	66
5.8	BIN Limit Test.....	68
5.8.1	Limit Mode	68
5.9	HANDLER Output	72
5.9.1	Set Input	72
5.9.2	Set Output.....	72
5.10	Use of TRIG IN/OUT	73
5.10.1	Connection.....	73
5.10.2	TRIG IN	73
5.10.3	TRIG OUT.....	73
5.11	Voltage Source Waveform Output	74
5.11.1	Single Staircase Sweep	74

5.11.2	Double Staircase Sweep	74
5.11.3	Square Waveform Output	74
5.11.4	List Sweep Output	75
5.12	Offset Cancel and Zero Correction	75
5.12.1	Zero Correction	75
5.12.2	Null, Offset Cancel	76
5.13	Measurement Considerations	76
5.13.1	Insulating Material.....	76
5.13.2	Leakage Current on Connection Parts.....	76
5.13.3	Humidity and Temperature	76
5.13.4	Offset	77
5.13.5	Cable Noise.....	77
5.13.6	External Noise.....	77
5.13.7	Dielectric Absorption.....	78
5.13.8	Capacitive Coupling	78
5.13.9	Light.....	79
Chapter 6	Interfaces and Communication	80
6.1	RS232	80
6.1.1	RS232 Interface Description.....	80
6.1.2	RS232 Interface Introduction.....	80
6.1.3	Communicate with a computer	82
6.2	LAN	82
6.2.1	LAN Remote System	82
6.2.2	System Configuration	82
6.3	USBTMC.....	83
6.3.1	USBTMC remote control system	83
6.3.2	System Configuration	83
6.4	USBCDC	83
6.4.1	USBCDC Virtual Serial Port	83
6.4.2	System Configuration	83
6.5	GPIB	83
6.5.1	GPIB Remote Control System	83
6.5.2	System Configuration	83
6.6	Communication Commands SCPI.....	83
6.6.1	Instruement Subsystem Commands.....	84
6.6.2	Public Commands.....	84
6.6.3	DISP Command Set.....	85
6.6.4	FUNC Command Set.....	85
6.6.5	VOLT Voltmeter Command Set	87
6.6.6	CURR Ammeter Command Set	90
6.6.7	RES Resistance Meter Command Set.....	92
6.6.8	CHAR Electrometer Command Set.....	95
6.6.9	SRC Voltage Source Command Set.....	98
6.6.10	FILT Filter Command Set.....	100
6.6.11	MATH Mathematical Command Set	101
6.6.12	WAVE Waveform Settings Command Set.....	102

6.6.13	BIN Limit Settings Command Set.....	107
6.6.14	VSFUNC Waveform Output Command Set	112
6.6.15	SYS System Command Set	119
6.6.16	HANDLER Settings Command Set.....	125
6.6.17	FETCH Inquiry Command Set.....	127
6.7	MODBUS Commands.....	129
6.7.1	Write Commands.....	129
6.7.2	Read Commands	129
6.7.3	DISP Command Set.....	130
6.7.4	FUNC Command Set.....	130
6.7.5	VOLT Command Set	131
6.7.6	CURR Command Set.....	132
6.7.7	RES Command Set	133
6.7.8	CHAR Command Set.....	134
6.7.9	SRC Command Set.....	135
6.7.10	FILT Command Set	135
6.7.11	MATH Command Set	136
6.7.12	WAVE Command Set.....	136
6.7.13	BIN Command Set	138
6.7.14	VSFUNC Command Set	138
6.7.15	SYS Command Set	140
6.7.16	HANDLER Command Set	142
6.7.17	FETCH Command Set	142
Chapter 7	Technical Parameter Specifications	144
7.1	Main Technical Specifications.....	144
7.2	Detaied Technical Specifications	144
	Current Measurement Accuracy:	144
	Resistance Measurement Accuracy:	145
	Voltage Measurement Accuracy:	145
	Charge Measurement Accuracy:	145
	Voltage Source Accuracy:	145
Chapter 8	Warranty	146

Chapte 1 Overview

Thank you for purchasing and using our products. Before using this instrument, please first check Chapter 8 "Warranty" in the manual. If there is any discrepancy, please contact us as soon as possible to protect your rights and interests.

1.1 Tonghui TH2690 Series

Tonghui TH2690 series provides the products listed below. Differences between models are summarized in Table 1-1.

- TH2690 Femtometer/Electrometer/High Resistance Meter

All in one instrument supporting the functions of DC voltage source, voltmeter, ammeter, electrometer, and high resistance meter. This instrument also performs staircase/list sweep voltage output, square wave voltage output, temperature measurement, and humidity measurement.

- TH2690A Picoammeter/Insulation Resistance Meter
- TH2691 Femtometer, Ammeter for measuring very low DC with resolution up to FEA
- TH2691A Picoammeter

TH2690 series use 5-inch LCD capacitive touch screen with several shortcut buttons. It supports various functions such as limit test, mathematical formula operation and drawing.

The SCPI (Standard Commands for Programmable Instruments) command can be used to automate measurements using an external computer.

TH2690 series supports RS232, USB, GPIB, LAN port connections.

Table 0-1 TH2690 series

Model	Minimum current resolution	Measurement function (maximum)				Voltage source (Maximum)
		Current	Voltage	Electric charge	Resistance ¹	
TH2690	0.1fA		±20V	±2μC	1000PΩ	±1000V
TH2690A	1fA	±20mA			10PΩ	
TH2691	0.1fA			/	/	/
TH2691A	1fA					

1.2 Inspecting the Shipment

Please perform the following inspections when the Tonghui TH2690 series and accessories arrive at your site.

1. Before unpacking any component, inspect all boxes for any signs of damage that might have occurred during shipment including dents, scratches, cuts, and water marks. If you inspect any damage, please contact Tonghui.

2. When you open the boxes that contain the TH2690 series and accessories, check the components against the contents lists attached to the boxes. If anything is found missing, please contact Tonghui.

3. Verify the operation of the TH2690 as described in “[Checking the Operation of TH2690](#)”. If any problem occurs, please contact Tonghui.

1.3 Operating Conditions

WARNING: Do not operate the instrument in environments with flammable gases or fumes.

Please operate the TH2690 series in indoor facilities.

1.3.1 Power ⚡

Power supply voltage: 100~240VAC (±10%) or 145~335VDC (±10%)

Power supply frequency: 50/60Hz (±5%)

Maximum volt-amps (VA) : 80VA

WARNING:

FIRE HAZARD: Use only the power cord supplied with your instrument. Using other types of power cord may cause overheating of the power cord, resulting in fire.

SHOCK HAZARD: The included power cord is a three-pronged power cord. Please plug it into the corresponding three-hole socket and make sure the socket is well grounded.

NOTE: The detachable power cord may be used as an emergency disconnecting

device. Removing the power cord will disconnect AC input power to the instrument.

1.3.2 Environmental Conditions

Normal Operating Temperature: $0^{\circ}\text{C} \sim 45^{\circ}\text{C}$, Humidity: 30% ~ 80%RH (non-condensing)

Reference Operating Temperature: $23^{\circ}\text{C} \pm 5^{\circ}\text{C}$, Humidity: 30% ~ 80%RH (non-condensing)

Storage Temperature: $-20^{\circ}\text{C} \sim 60^{\circ}\text{C}$, Humidity: 10% ~ 90%RH (non-condensing)

1.3.3 Preheating

Preheating time after booting up: $\geq 60\text{min}$

1.4 Checking the Operation of TH2690

1. Connect the power cord from the TH2690's rear panel AC input connector (receptacle) to an AC power outlet at your site.

2. Press the standby switch to turn on the instrument. The initialization screen will appear on the TH2690's front panel display and the power-on self-test is automatically executed. If the TH2690 is operating normally, the front panel LCD displays the image as shown below.

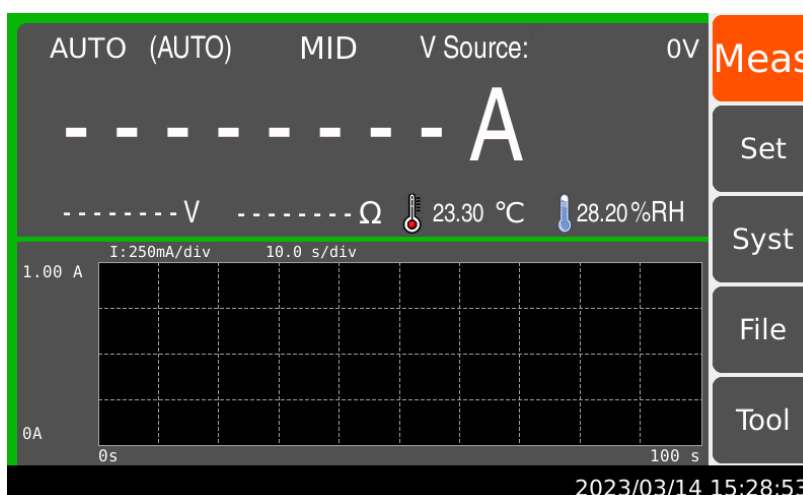

1.5 Checking for Errors

Errors can be checked as described below:

1. Press Tool, the following interface will be shown



2. Press the “Error” icon. Check the errors displayed on the dialog box. If no error is detected, “Errorcode: 0, No Errorcode” is displayed.

3. Press  to close the dialog box.

Chapter 2 Points for notice

Before any installation or operation, please inspect the TH2690 and revise safety warnings in the user manual. Specific safety warnings are in the corresponding sections in the manual.

The following general safety precautions must be observed during all phases of operation, service, and repair of this instrument. Failure to comply with these precautions or with specific warnings elsewhere in this manual may impair the protections provided by the instrument. In addition, it violates safety standards of design, manufacture, and intended use of the instrument. Tonghui assumes no liability for customer's failure to comply with these requirements.

2.1 Safety Precautions

NOTE: Do not use this instrument in any manner not specified by the manufacturer. The protective features of this instrument may be impaired if it is used in a manner not specified in the operation instructions.

This instrument is an INDOOR USE product.

Safety of any system incorporating the equipment is the responsibility of the assembler of the system.

WARNING: Hazardous voltage of up to the instrument's maximum voltage may appear at High terminal if Interlock terminal is closed. Open the Interlock terminal when the High terminal is accessible. Voltage applied to the terminals will be limited up to ± 21 V.

Do not work the interlock function intentionally to bring the output voltage to the safe level. While the high voltage indicator is lit, the dangerous voltage by the output voltage or the residual charge appears on the measurement terminal.

- Warning Signs for Dangerous procedures

Please read and follow all the **WARNING** messages to avoid potential hazards. All the instructions in the warning messages must be followed.

WARNING: The warning sign denotes a hazard. It calls attention to a procedure, practice, condition, or the like which if not correctly performed or adhered to, could result in injury or death to personal.

CAUTION: The caution sign denotes a hazard. It calls attention to an operating procedure, practice, condition, or the like which, if not correctly performed or adhered to, could result in damage to or destruction of part or all of the equipment.

- Before Applying Power

Verify that all safety precautions are taken. Make all connections to the instrument before applying power.

- Ground The Instrument

This is Safety Class I instrument. To minimize shock hazard, the instrument chassis and cabinet must be connected to an electrical ground. The power terminal and the power cable must meet International Electrotechnical Commission (IEC) safety standards.

- Do Not Operate in An Explosive Atmosphere

Do not operate the instrument in the presence of flammable gases or fumes. Operation of any electrical instrument in such an environment constitutes a definite safety hazard.

- Do Not Open Cover

No operator serviceable parts inside. Refer servicing to qualified personnel. To prevent electrical shock, do not remove covers.

- In Case of Damage

Instruments that appear damaged or defective should be made inoperative and secured against unintended operation until they can be repaired by qualified service personnel. Return the instrument to Tonghui sales or service office for services and repair to ensure that safety features are maintained.

- Use Only Specific Accessories

Specific accessories satisfy the requirements for specific characteristics for using the

instrument. Use the specific accessories, cables, adapters, and so on for safety reasons.

2.1.1 Power Supply and Measurement Safety

- Power Supply Safety

This instrument can output high currents and voltages. Make sure that the load or device under test can safely handle the output current and voltage. Also, make sure that the connection leads can safely withstand the expected currents and are insulated for the expected voltages.

The instrument outputs may be connected so as to float relative to earth ground. Isolation or floating voltage ratings are indicated on the instrument, near the output terminal or the Chassis ground terminal. There is the danger of electric shock by touching the floated measurement terminals. Keep in mind it to protect yourself. And it is a reason of using the recommended accessories.

- Voltage/Current Measurement Safety

This instrument is subject to certain safety concerns due to the high voltage and current circuits it may be connected. To safely use these instruments, you need to understand the markings on the instrument near the input terminals, which include the Protection Limits and the IEC Measurement Category.

- Protection Limits

Tonghui TH2690 series' ammeters and voltmeters provide protection circuitry to prevent damage to the instrument and to protect against the danger of electric shock, provided the Protection Limits are not exceeded. To ensure safe operation of the instrument, do not exceed the Protection Limits shown on the input terminals.

- Voltage Source Terminals on Tonghui TH2690/TH2690A

Keysight TH2690/TH2690A can apply DC voltage up to 1000 V between High and Low terminals. Voltage marked between the earth terminal and the Low/Common terminal indicates the floating usage limits.

2.1.2 High Voltage Shock Hazard



Tonghui TH2690/TH2690A can apply dangerous voltages ($\pm 1000\text{V}$) at the High/Low

terminal. To prevent electric shock hazard, the following safety precautions must be observed during the use of Tonghui TH2690/TH2690A:

- Use a three-conductor AC power cable to appliance coupler (inlet) and the instrument to an electric ground (safety ground).
- Prepare shielding box which covers interface to a device under test and equipped with interlock circuit that opens when the door is opened.
- Before performing measurement, connect the interlock circuit to the Interlock terminal of this instrument.
- Confirm periodically that the interlock function works normally.
- Before touching the connections of the High/Low terminal, turn the instrument off and discharge any capacitors of the measurement path. If you do not turn the instrument off, complete “all” of the following items, regardless of any instrument’s settings:
 - ✓ Terminate source output by pressing the (Source) switch; confirm that the switch turns off.
 - ✓ Confirm that the HV (high voltage) status indicator is not lit.
 - ✓ Open the shielding box access door (open the Interlock terminal).
 - ✓ Discharge any capacitors if the capacitance is connected to this instrument.
- Warn workers in the vicinity of the instrument about hazardous conditions.

2.1.3 Insulation Resistance

Under reference operating conditions, the insulation resistance between the power terminal and the external case is not less than 50M Ω ;

Under warm and humid transport conditions, the insulation resistance between the power terminals and the external case is not less than 2M Ω .

2.1.4 Dielectric Strength

Under reference operating conditions, the rated voltage between the power terminal and the housing can withstand 2.1kV DC voltage for 1 min, without breakdown and arcing

phenomenon.

2.1.5 Leakage Current

Leakage current is not greater than 3.5mA.

2.2 Electromagnetic compatibility

Power supply transient sensitivity is according to the requirements of GB6833.4.

Conductivity sensitivity is according to the requirements of GB6833.6.

Radiation interference is according to the requirements of GB6833.10.

Chapter 3 Introduction to panels

The content of this chapter is only a general description; please refer the specific operation and detailed explanations to the corresponding content of Chapter 4.

3.1 Introduction to the Front Panel

Figure showing the TH2690 Front Panel



- LCD Touch Screen

5-inch color TFT touch screen. Operations can be done using the touch screen. It displays the instrument setup, measurement result, status information, etc. The status information is displayed near bottom of the display.

NOTE: All the operations of this instrument are done on the touch screen by pop-up box selection, input box input, and scroll bar dragging.

- Power Switch

Turn the instrument ON/OFF. After connecting to power, press the power switch, the switch light turning green indicates that the instrument is booted correctly. When the instrument is powered on, press and hold the power switch to turn it off. This instrument supports auto startup function which can recover from suddun shutdown after reconnecting to power.

- USB-A connector

It is used to connect a USB flash drive. After disconnecting the USB flash drive, wait 10 seconds before connecting it again or new one.

CAUTION: Turning the instrument off while the USB flash drive is being accessed may damage the device.

- Run/Stop key

Starts measurement (stops measurement). The measurement result is displayed on the Meter view, Histogram view, or Roll view.

- Voltage Source Key (Source), for TH2690/TH2690A

Enables or disables Voltage Source Output. In the ON status, the Voltage Source High terminal is connected to the voltage source and the switch light turns green. In the OFF status, it is opened and the switch light turns off. The switch turns red if the voltage source is in the high voltage state (over $\pm 20V$).

NOTE: When Source Setting - Waveform Output is set to OFF, starting voltage source (front panel Source key) will output the set voltage value.

- Ammeter key

Enables or disables Ammeter Input. In the ON status, the Ammeter triaxial connector's center conductor is connected to the ammeter and the switch light turns green. In the OFF status, it is connected to the circuit common and the switch light turns off. In the ON status, press the ammeter key (green) turns it to the OFF status.

Turn the ammeter on to perform current measurement (and the charge and resistance measurements).

The instrument performs the voltage measurement regardless of this setting.

- Function Key (Func), for TH2690/TH2690A

Switch between different measurements on the main display area of the instrument.

- Zero Correction (ZERO)

Enables or disables zero correction (offset cancel).

- Voltage Source Terminal Voltage sources high terminal (High) and low terminal(Low) for TH2690 and TH2690A



The banana-type terminal for DC voltage output of up to $\pm 1000\text{V}$ can be controlled by the voltage source key (Source) to turn the voltage source on or off. Set the low end to connect to the circuit Common or Float.

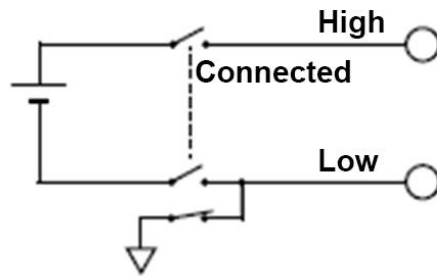

- Ammeter input connector

Triaxial connector for current measurement, the ammeter is switched on and off by the Ammeter key

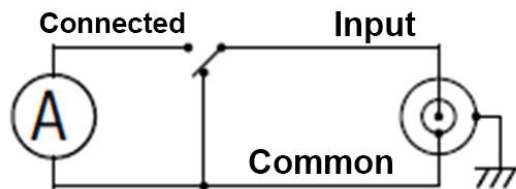

- Voltmeter input connector, for TH2690/TH2690A

Triaxial connector for voltage measurement, set the voltmeter inner shield connection to the Guard terminal or the Common terminal.

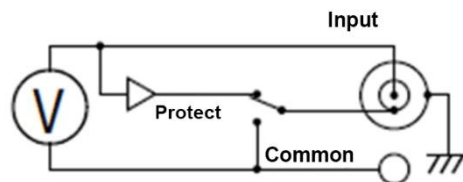

- Common terminal (Common)

It is the Banana terminal for circuit common. This is the Common for the Ammeter, the Voltmeter, and the Analog Out. For the grounded measurement, this

terminal must be connected to the earth (ground) terminal by using a Banana-to-Lug cable (furnished).

WARNING: If the Common terminal is not connected to the earth (ground) terminal (for floating measurement), potentially hazardous voltage of up to ± 500 V may be applied to the Common terminal. To prevent electrical shock, do not touch any of measurement circuit at any time while a floating measurement is in progress. Also use accessories from Thonghui. All terminals and the extended conductors must be isolated by using insulation caps, sleeves, etc.

- Earth (ground) terminal

Terminal connected to earth (ground) through the power cord. This terminal is also connected to the frame (chassis) of this instrument.

CAUTION: Do not apply current to this terminal. Doing so will damage the instrument.

3.2 Introduction to the rear panel

Figure showing the TH2690 rear panel.



- Analog Output Connector (Analog Out)

A 3-pin connector for analog signal output, from left to right, pin 1 for analog signal earth (COMMON), pin 3 for analog signal output. It always outputs the voltage proportional to the present measurement result. Maximum output voltage is ± 2 V.

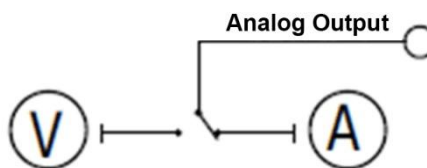

For example, the output voltage is 2 V if the measurement result is the full scale value of the measurement range or 0.2 V if the result is 10 % of the full scale.

- Trigger In and Out connector (Trigger)

A 3-pin connector for input and output trigger signal. From left to right, pin 1 for GND, pin 2 for trigger output, and pin 3 for trigger input. It is used to perform the operation synchronized with external equipment.

- Handler Connector

D-sub 9 pin female connector. For more information, see "[Handler](#)"

- LAN interface connector

Connects to 10/100 Base-T interface. Left LED indicates activity. Right LED indicates link integrity.

- USB-B connector

Connects to USB interface

- GPIB interface connector

Use GPIB cable to connect to an external computer or equipment.

- AC input connector

AC power cord is connected to this receptacle.

- Serial Number

The serial number label is attached to the bottom of the instrument.

- Interlock connector (Interlock), for TH2690/TH2690A

The connector is used for the interlock function. If the interlock terminals are open, the instrument output is limited to ± 21 V. Be sure to connect the terminals to an interlock circuit installed in a test fixture or a connection interface for performing measurements over this limit. If there is no interlock circuit, you need to install it. For details on how to install the interlock circuit, see "[Installing the Interlock Circuit](#)".

The instrument is equipped with a connector MPC300-250 (4-pin) or equivalent for connecting interlock circuits.

WARNING: Dangerous voltage of up to the maximum voltage of ± 1000 V may be present between the High and Low terminals of the Voltage Source if the Interlock terminal is closed.

- Connector for temperature and humidity sensor for TH2690 and TH2690A

It is used as a connector for temperature and humidity sensors that measure temperature and relative humidity.

The instrument is equipped with a connector MPC300-250 (3-pin) or equivalent for connection to the temperature and humidity sensor AM2105A or equivalent. The temperature and humidity sensor is an optional device.

Chapter 4 Operation Instructions

This chapter describes how to operate the Tonghui TH2690 series.

4.1 Home Screen Introduction

The figure shows the home screen display.

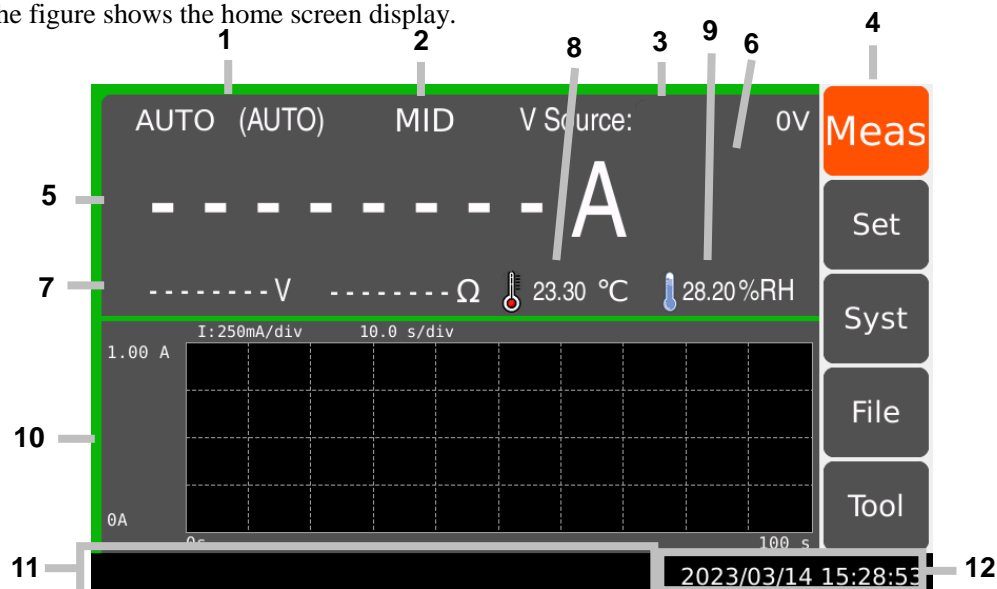

Display Area:

1. Set the measuring range
2. Set the measuring speed
3. Voltage Source: The output voltage of the voltage source. When the source setting is configured as waveform output, the source waveform indicator is displayed this time, same for staircase sweep, list sweep, and square waveform.
4. The menu for the detailed settings of various functions of the instrument
5. The main measurement value
6. In sorting or limit testing, this area displays PASS/FAIL or limit results
7. The sub measurement value
8. Temperature measurement value, displays when sensor is connected.

Displayed unit can be °C or °F.

9. Humidity measurement value, displays when sensor is connected.
10. Here you can choose to display a bar chart, line chart or no chart.

11. Status information. The following indicators are available.

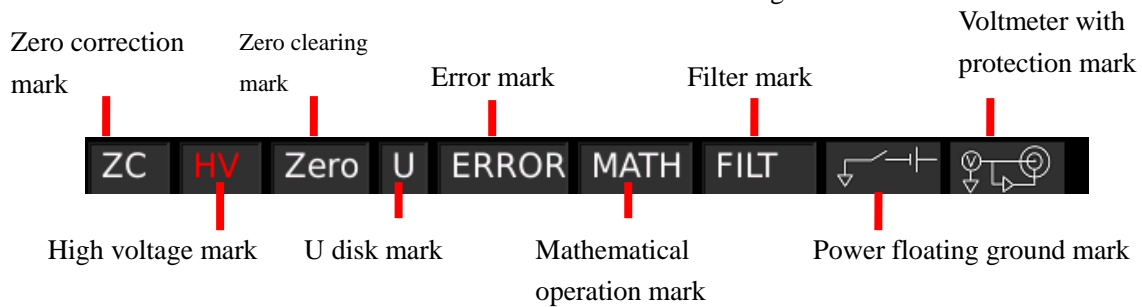

4.2 Measurement Settings

Under Set – Meas Set interface, settings of the parameters for each function are available.

4.2.1 Ammeter Settings

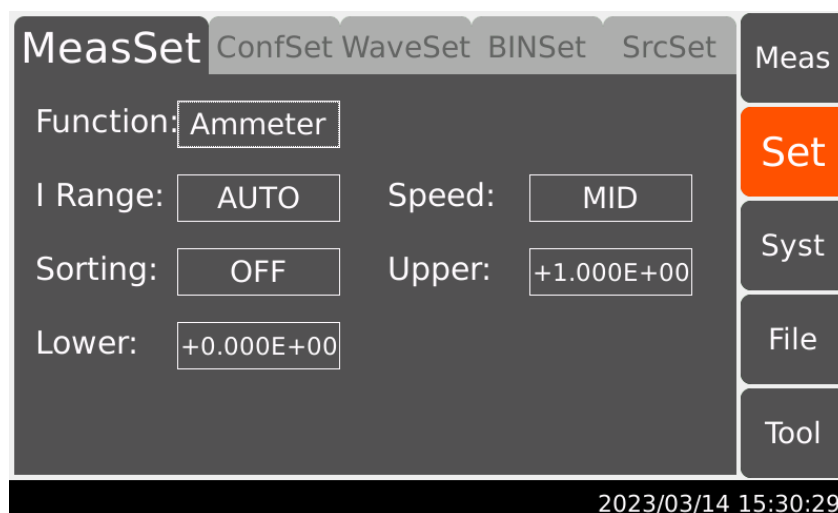

- Current Measurement Range (I Range)

Optimal range for ammeter measurement values. While the ammeter is running, select I Range and choose the measurement range by touching the check box on the screen.

Auto ---- appropriate range automatically selected by the instrument

20mA ---- 2mA~20mA

2mA ---- 200uA~2mA

200uA ---- 20uA~200uA

20uA ---- 2uA~20uA

2uA ---- 200nA~2uA

200nA ---- 20nA~200nA

20nA ---- 2nA~20nA

2nA ---- 200pA~2nA

200pA ---- 20pA~200pA

20pA ---- 0~20pA

- Measurement Speed

Choose the speed of measurements.

FAST ---- 1*PLC (20ms) , quick

MID---- 10*PLC (200ms)

SLOW ---- 100*PLC (2000ms) , stable

- Sorting Switch

This function can set the sorting mode on or off; sorting results are displayed in the measurement interface.

ON ---- Sorting mode On

OFF---- Sorting mode Off

- Upper

Set the sorting upper limit

- Lower

Set the sorting lower limit

4.2.2 Voltmeter Settings

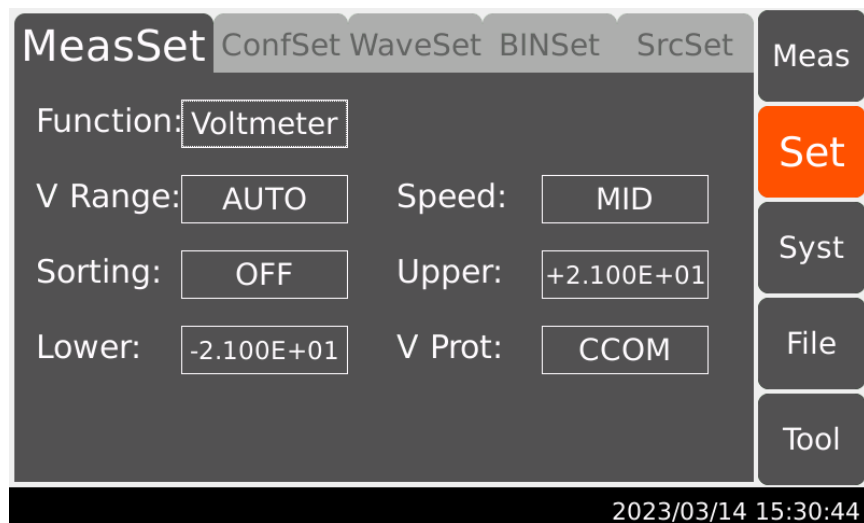

- Voltmeter Range (V Range)

Optimal range for voltmeter measurement values. While the voltmeter is running, select V Range and choose the measurement range by touching the check box on the screen.

Auto ---- appropriate range automatically selected by the instrument

2V ---- 0~2V

20V ---- 2V~20V

- Measurement Speed

Choose speed of measurements.

FAST ---- 1*PLC (20ms) , quick

MID ---- 10*PLC (200ms)

SLOW ---- 100*PLC (2000ms) , stable

- Sorting Switch

This function can set the sorting mode on or off; sorting results are displayed in the measurement interface.

ON ---- Sorting mode On

OFF---- Sorting mode Off

- Upper

Set the sorting upper limit

- Lower

Set the sorting lower limit

- Voltage Protection

This function can set the state of the inner shield of the triaxial connector at the voltmeter input terminal.

GUARD ---- inner shield connected to Guard (Guard), connection used for guarded voltage measurement, measurement results are relatively more accurate. Indicator on, shows voltmeter mark being protected. 

CCOM ---- inner shield connected to Common (Common), connection used for unguarded voltage measurement, ease for use. Indicator off.

4.2.3 High Resistance Meter

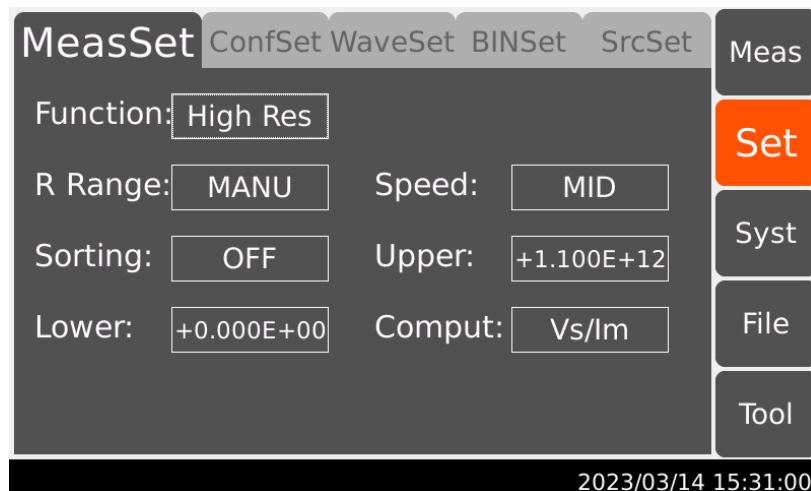

- Resistance Range (R Range)

Optimal range for high resistance meter measurement values. While the high resistance meter is running, select R Range and choose the measurement range by touching the check box on the screen.

Auto ---- appropriate range automatically selected by the instrument

100TΩ ---- 10TΩ~100TΩ

10TΩ ---- 1TΩ~10TΩ

1TΩ ---- 100GΩ~1TΩ

100GΩ ---- 10GΩ~100GΩ

10GΩ ---- 1GΩ~10GΩ

1GΩ ---- 100MΩ~1GΩ

100MΩ ---- 10MΩ~100MΩ

10MΩ ---- 1MΩ~10MΩ

1MΩ ---- 100kΩ~1MΩ

Manual ---- uses internal/external voltage source, choose the voltage measurement range from the measurement interface.

- Measurement Speed

Choose the speed of measurements.

FAST ---- 1*PLC (20ms) , quick

MID ---- 10*PLC (200ms)

SLOW ---- 100*PLC (2000ms) , stable

- Sorting Switch

This function can set the sorting mode on or off; sorting results are displayed in the measurement interface.

ON ---- Sorting mode On

OFF ---- Sorting mode Off

- Upper

Set the sorting upper limit

- Lower

Set the sorting lower limit

- Compute

Function to set the computing mode for resistance

Vm/Im ---- Displays high resistance value = voltmeter measurement value / ammeter measurement value

Vs/Im ---- Displays high resistance value = internal voltage source voltage value / ammeter measurement value

4.2.4 Electro Meter Settings

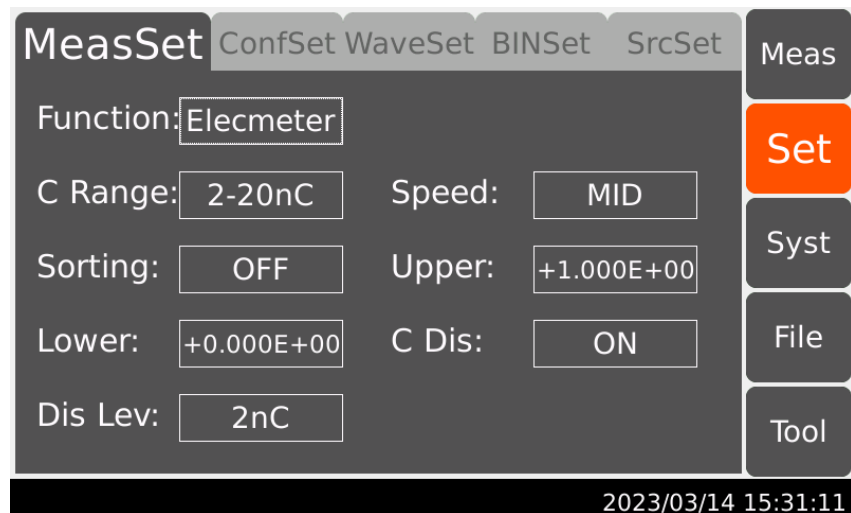

- Charge Range

Optimal range for electro meter measurement values. While the electro meter is running, select C Range and choose the measurement range by touching the check box on the screen.

2-20nC ---- appropriate range automatically selected between 2nC or 20nC

0.2-2uC ---- appropriate range automatically selected between 200nC or 2uC

2nC ---- 0~2nC

20nC ---- 2nC ~20nC

200nC ---- 20nC ~200nC

2uC ---- 200nC ~2uC

- Measurement Speed

Function to choose the measurement speed

FAST ---- 1*PLC (20ms) , quick

MID ---- 10*PLC (200ms)

SLOW ---- 100*PLC (2000ms) , stable

- Sorting Switch

This function can set the sorting mode on or off, sorting results are displayed in the measurement interface.

ON ---- Sorting mode On

OFF ---- Sorting mode Off

- Upper

Set the sorting upper limit

- Lower

Set the sorting lower limit

- Discharge

If this function is enabled, the coulomb meter resets the charge when the charge reaches the specified level.

ON ---- Discharge

OFF ---- No Discharge

- Discharge Level

This function sets the level of discharge

2nC ---- Discharge when the charge reaches 2nC

20nC ---- Discharge when the charge reaches 20nC

200nC ---- Discharge when the charge reaches 200nC

2000nC ---- Discharge when the charge reaches 2000nC

4.2.5 Voltage Source Settings

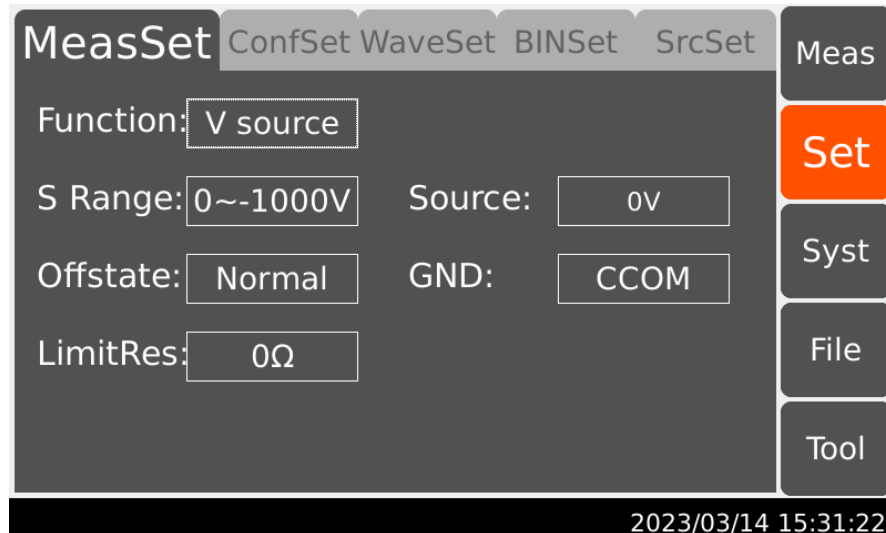

- Source Range (S Range)

This function sets the voltage source range

-20~20V ---- output range -20~20V

0~1000V ---- output range 0~1000V

-1000~0V ---- output range -1000~0V

- Voltage Source

Set the output value for the voltage source

- Off State

This function sets the state when voltage source output is off.

High Z ---- High resistance state, output switch of the ammeter is off, voltage source settings remain unchanged, only used for voltage source measurement range between -20V~20V

Normal ---- Voltage Output becomes 0V, output switch of the ammeter is off.

Zero ---- Voltage output becomes 0V

- GND

This function sets whether the voltage source low terminal is connected to the circuit common.

CCOM ---- voltage source low terminal is connected to the circuit common (common), Float indicator is off.

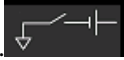
FLOAT ---- voltage source low terminal is not connected to the circuit common (common), Float indicator is on. 

- Current Limiting Resistance (LimitRes)

This function sets whether the voltage source is in series with 20MΩ current limiting resistance.

0Ω ---- not in series with current limiting resistance

20MΩ ---- in series with 20 MΩ current limiting resistance

4.3 Configuration Settings

Under Set-ConfSet, Filter and Math settings are available.

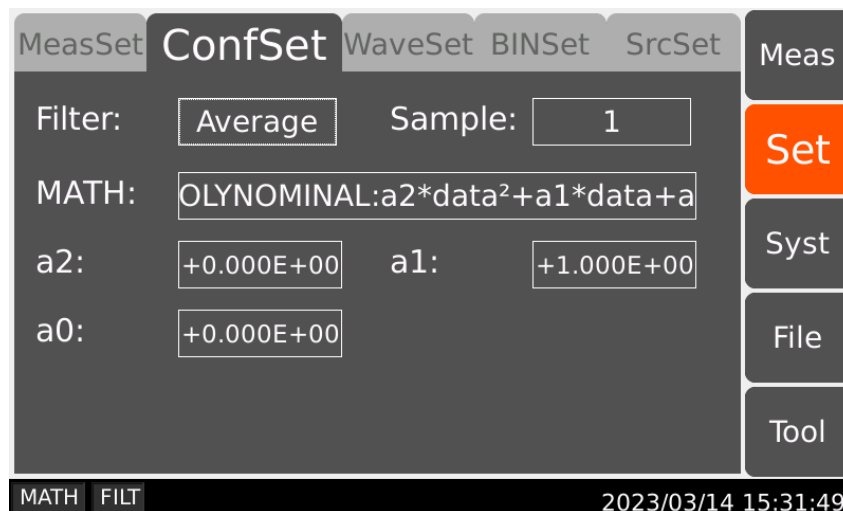

4.3.1 Filter

- Filter Mode

This function sets the filter mode for measurement results.

1. Average

This filter calculates a sum of samples in the certain range (number of samples), then divides it by the number of samples.

For example: Assuming the number of samples is 5, 5 measurements are A,B,C,D,E, then the filter result is calculated by taking the average:

$$(A+B+C+D+E) /5.$$

2. Median

This filter is used to determine the middle-most sample from a group of samples that are arranged according to size. The group is shifted by discarding the oldest sample and adding the latest sample to calculate the middle-most sample in the new group. The sample size must be an odd number smaller than 12.

For example: Assuming the sample size to be 3, measurement results are 1, 2, 100, 5, 6..... then the output is 2, 5, 6

3. Slide

This filter calculates a sum of samples in the certain range (number of samples), then divides it by the number of samples. The range is shifted by discarding the oldest sample and adding the latest sample to calculate an average of samples in the new range. Filter sample size need to be an integer from 1-100.

For example: Set the filter sample size to be 3, the measurement results are 2, 4, 6, 8, 10, 12, 14..... then the ouput is 4, 6, 8, 10, 12.....

4.3.2 MATH

This function performs mathematical function calculations on the measurement results

Scale Offset ---- $k*data+b$ define k,b

Reciprocal Scale Offset ---- $k/data+b$ define k,b

Ratio ---- $data/std$ define std

Percent ---- $(data/std)*100\%$ define std

Deviation ---- $(data-std)/std$ define std

Percent Deviation	----	$[(data-std)/std]*100\%$	define std
Log	----	$\log(data)$	
Polynomial	----	$a2*data^2+a1*data+a0$	define a2,a1,a0
Sheet Resistivity	----	$(ep/gl)*data$	define ep,gl
Volume Resistivity	----	$ea/st*data/10$	define ea,st

4.4 Wave Form Settings

Set the Wave Form under Set-WaveSet.

4.4.1 Graph

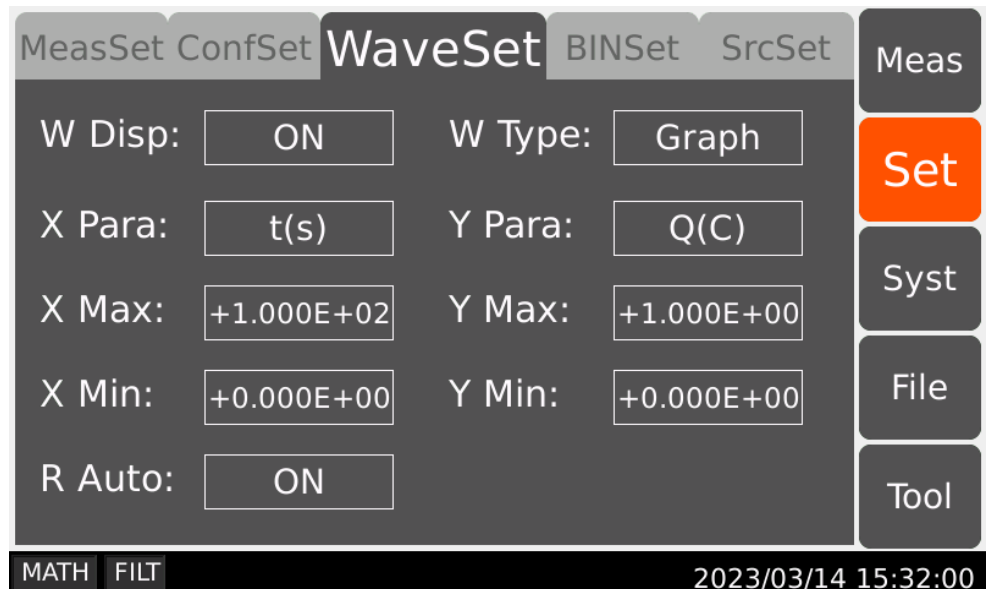

- Wave Form Display (W Disp)

This function toggles wave form display on or off.

ON ---- Display on, shown in the Measurement interface.

OFF ---- Display off, not shown in the Measurement interface.

- Wave Form Type (W Type)

This function sets the wave form types

Graph ---- Measurement results shown in Graph form

Histogram ---- Measurement results shown in Histogram form

- X Parameter (X Para)

This function sets the X-axis parameter

t(s) ---- Time Measurement Value

MATH ---- Mathematical Function Measurement Value

I(A) ---- Current Measurement Value

U(V) ---- Voltage Measurement Value

R(Ω) ---- Resistance Measurement Value

SRC---- Internal Voltage Source Value

Q(C) ---- Charge Measurement Value

- Y Parameter (Y Para)

This function sets the Y-axis parameter

MATH ---- Measurement Mathematical Function Value

I(A) ---- Measurement Current Value

U(V) ---- Measurement Voltage Value

R(Ω) ---- Measurement Resistance Value

Q(C) ---- Measurement Charge Value

- Xmax, Xmin

This function sets the max/min values for the X axis

- Ymax, Ymin

This function sets the max/min values for the Y axis

- Range Auto (R Auto)

This function sets whether the Y axis automatically adjust its range

ON ---- Y Axis range automatically adjusted

OFF ---- Y Axis range set to Ymax, Ymin

4.4.2 Histogram

- X Parameter (X Para)

This function sets the displaying parameter for the X axis

MATH ---- Mathematical Funtion Measurement Value

I(A) ---- Current Measurement Value

U(V) ---- Voltage Measurement Value

R(Ω) ---- Resistance Measurement Value

Q(C) ---- Charge Measurement Value

4.5 BIN Settings

Set the parameters for limit testing (sorting) under Set-BINSet.

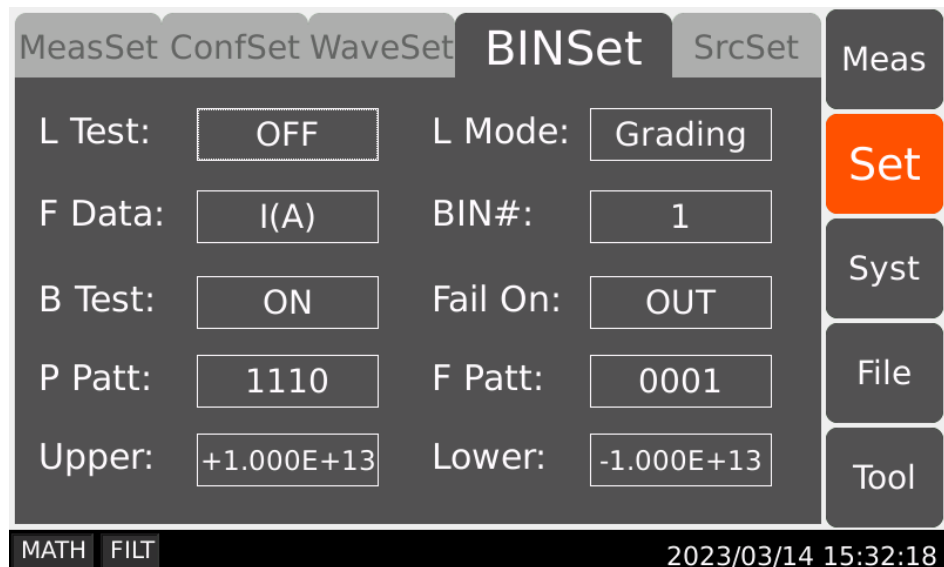

- Limit Test (L Test)

This function toggles limit test on or off.

ON ---- Limit Test function On

OFF ---- Limit Test function Off

- Limit Mode (L Mode)

This function chooses the mode for Limit Test

Grading ---- Generally used for grading unqualified products

Sorting ---- Generally used for screening qualified products

- Feed Data (F Data)

Used for choosing data type for limit test

I(A) ---- Current Measurement Data

U(V) ---- Voltage Measurement Data

R(Ω) ---- Resistance Measurement Data

Q(C) ---- Charge Measurement Data

- Bin# Select (BIN#)

Used for choosing 7 different Bin#

- Bin Test Select (B Test)

Switch to toggle on/off the current Bin#

ON ---- Limit Test with current Bin# on

OFF ---- Limit Test with current Bin# off

- Fail On Select (Fail On)

Set the Fail judgement whether in or out of the range.

IN ---- Failed by inside the upper and lower limit

OUT ---- Failed by outside the upper and lower limit

- Pass Pattern (P Patt)

The Handler Output Bit Pattern for the limit test pass state, used for the sorting mode.

- Fail Pattern (F Patt)

The Handler Output Bit Pattern for the limit test fail state, used for the sorting mode.

- Sorting Upper Limit

Set the upper limit for sorting

- Sorting Lower Limit

Set the lower limit for sorting

4.6 Source Setting

Set for Voltage Source Waveform Output under Set-SrcSet.

4.6.1 Linear Single (LinearS)

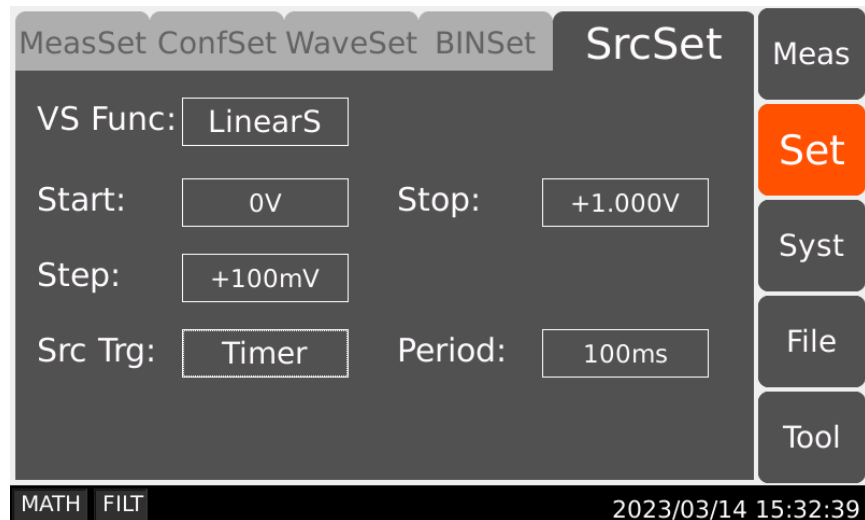

- Starting Voltage (Start)

Set the starting voltage for linear single function

- Stopping Voltage (Stop)

Set the stopping voltage for linear single function

- Stepping Voltage

Set the stepping voltage for linear single function

- Trigger Mode:

Set the trigger mode for linear single function

Trigger ---- when selected, staircase sweep outputs everytime it triggers.

Timer ---- when selected, staircase sweep outputs after every set timer passed.

- Period

Set the time period when the trigger mode is timer.

4.6.2 Linear Double (LinearD)

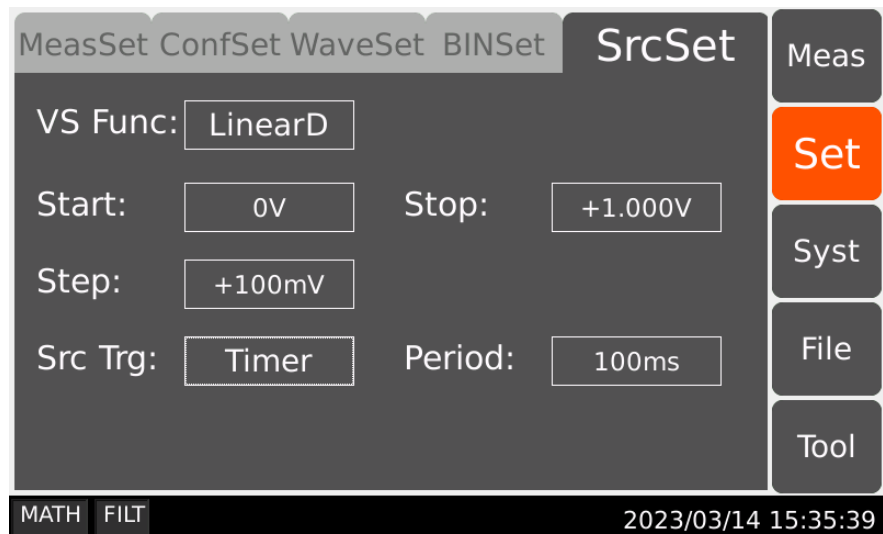

- Starting Voltage (Start)
 - Set the starting voltage for linear double function
- Stopping Voltage (Stop)
 - Set the stopping voltage for linear double function
- Stepping Voltage
 - Set the stepping voltage for linear double function
- Trigger Mode:
 - Set the trigger mode for linear single function
 - Trigger ---- when selected, staircase sweep outputs everytime it triggers.
 - Timer ---- when selected, staircase sweep outputs after every set timer passed.
- Period
 - Set the time period when the trigger mode is timer.

4.6.3 Square Waveform Output (ARB Squ)

The screenshot shows the 'SrcSet' menu in the TH2690 Series interface. The menu is titled 'SrcSet' and has a 'Meas' button on the right. The main area contains the following fields and values:

VS Func:	ARB Squ		
Start:	0V	Delay:	100ms
Peak:	+1.000V	P Delay:	100ms
E Time:	1.000s	Count:	1

On the right side of the menu, there are five buttons: 'Meas', 'Set' (highlighted in orange), 'Syst', 'File', and 'Tool'. At the bottom of the screen, there are 'MATH' and 'FILT' buttons on the left, and a timestamp '2023/03/14 15:36:01' on the right.

- Starting Voltage (Start)

Set the starting voltage for square waveform function
- Delay

Set how long time the starting voltage lasts for.
- Peak

Set the peak voltage
- Peak Delay (P Delay)

Set how long time the peak voltage lasts for.
- Ending Time (E Time)

Set how long the ending time lasts for.
- Count

Set how many times the square waveform function repeats.

4.6.4 List

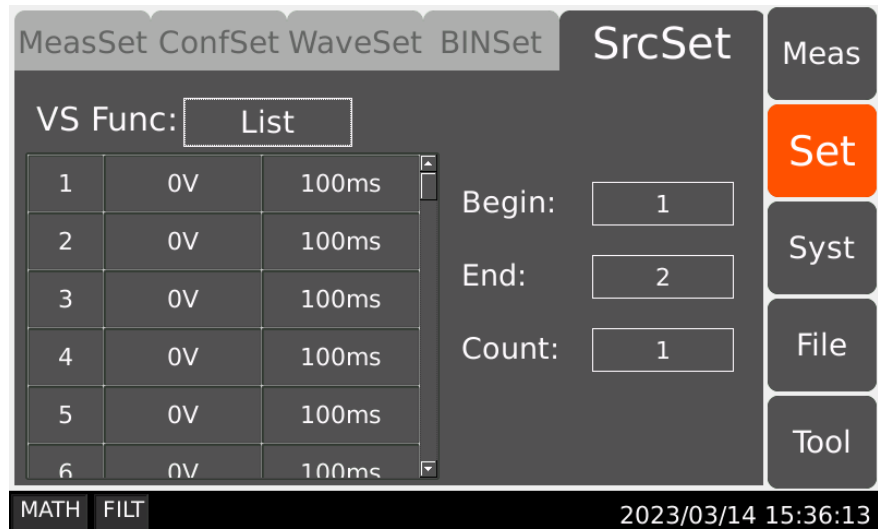

- **Begin**
Set from which number on the list the function starts with.
- **End**
Set till which number on the list the function ends with.
- **Count**
Set how many times the list function repeats.
- **Assign Voltage**
Assign voltage value in the corresponding field.
- **Assign Timer**
Assign how long the output voltage lasts for.

4.7 Environment System

Configurations for Environment System is under Syst-EnviSys.

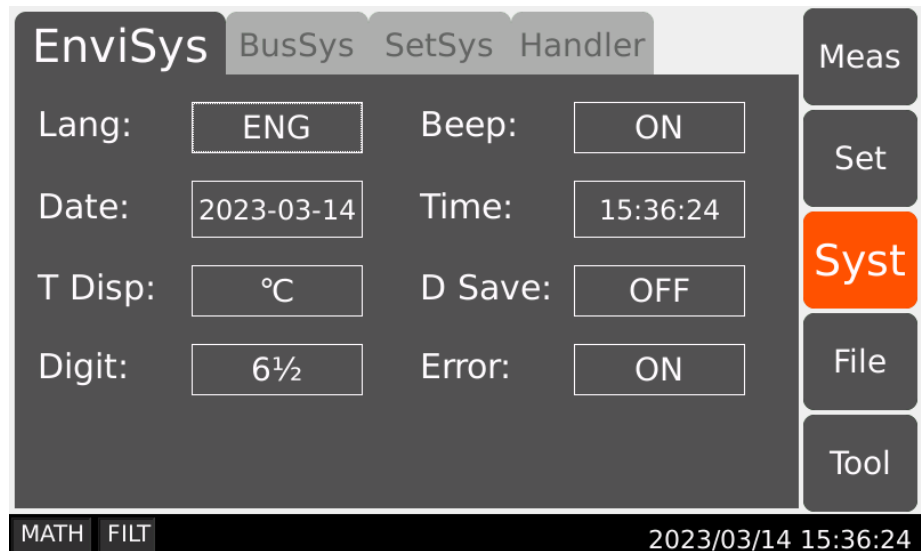

- Language

Set the system language for the instrument.

CHN ---- Chinese

ENG ---- English

- Beep

Turn the beeper On or Off.

ON ---- Beeper On

OFF ---- Beeper Off

- Date

Set the system date for the instrument.

- Time

Set the system time for the instrument.

- Temperature Display (T Disp)

Unit the temperature is displayed in.

°C ---- Celsius degree

°F ---- Degrees Fahrenheit

- Data Save (D Save)

Save measurement data, in .CSV format to the USB flash drive.

ON ---- Data Save On

OFF ---- Data Save Off

Saved Data example (Open with Excel) :

Date	2021/11/10 13:56							
Time	Volt	Curr	Res	Coul	Math	Src	Temp	Hum
13:57:03.0	3.06E+00	1.99E-05	1.00E+06	0.00E+00	--.--	2.00E+01	2.43E+01	2.64E-01
13:57:03.3	3.06E+00	1.99E-05	1.00E+06	0.00E+00	--.--	2.00E+01	2.43E+01	2.64E-01
13:57:03.6	3.06E+00	1.99E-05	1.00E+06	0.00E+00	--.--	2.00E+01	2.43E+01	2.64E-01
13:57:03.9	3.06E+00	1.99E-05	1.00E+06	0.00E+00	--.--	2.00E+01	2.43E+01	2.64E-01
13:57:04.1	3.06E+00	1.99E-05	1.00E+06	0.00E+00	--.--	2.00E+01	2.43E+01	2.64E-01
13:57:04.4	3.06E+00	1.99E-05	1.00E+06	0.00E+00	--.--	2.00E+01	2.43E+01	2.64E-01
13:57:04.7	3.06E+00	1.99E-05	1.00E+06	0.00E+00	--.--	2.00E+01	2.43E+01	2.64E-01
13:57:05.0	3.06E+00	1.99E-05	1.00E+06	0.00E+00	--.--	2.00E+01	2.43E+01	2.64E-01
13:57:05.2	3.06E+00	1.99E-05	1.00E+06	0.00E+00	--.--	2.00E+01	2.43E+01	2.64E-01
13:57:05.5	3.06E+00	1.99E-05	1.00E+06	0.00E+00	--.--	2.00E+01	2.43E+01	2.64E-01
13:57:05.8	3.06E+00	1.99E-05	1.00E+06	0.00E+00	--.--	2.00E+01	2.43E+01	2.64E-01
13:57:06.1	3.06E+00	1.99E-05	1.00E+06	0.00E+00	--.--	2.00E+01	2.43E+01	2.64E-01
13:57:06.3	3.06E+00	1.99E-05	1.00E+06	0.00E+00	--.--	2.00E+01	2.43E+01	2.64E-01

- Digit

Change how many digits the measurement results are displayed in

3½ ---- results shown in three and a half digits

4½ ---- results shown in four and a half digits

5½ ---- results shown in five and a half digits

6½ ---- results shown in six and a half digits

4.8 BUS System

Configurations for the remote interface of the instrument, under Syst-BusSys.

4.8.1 RS232

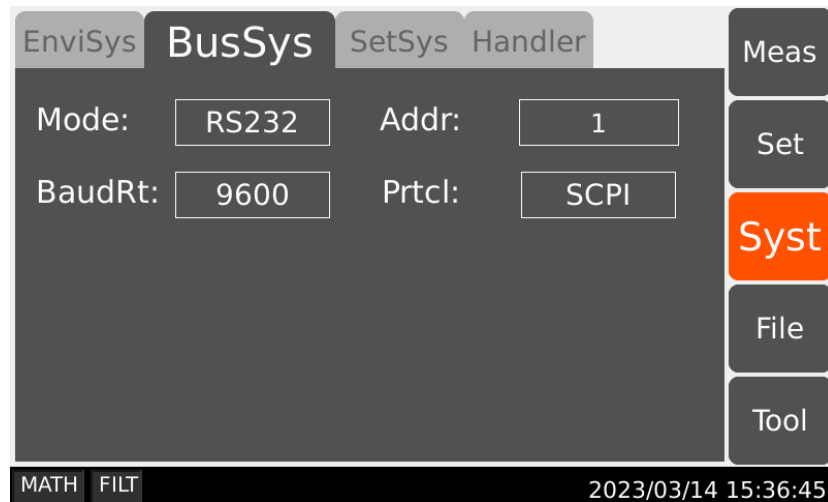

- Address (Addr)

Set the address of the instrument when using the MODBUS protocol.

- Baud Rate (BaudRt)

Set the baud rate.

9600 ---- set the baud rate to be 9600

38400 ---- set the baud rate to be 38400

57600 ---- set the baud rate to be 57600

115200 ---- set the baud rate to be 115200

- Communication Protocol (Prtcl)

Set the type of protocol for RS232

SCPI ---- set the protocol to be SCPI

MODBUS ---- set the protocol to be MODBUS

4.8.2 LAN

EnviSys	BusSys	SetSys	Handler	Meas				
Mode:	LAN	Addr:	1	Set				
Port:	45454			Syst				
IPAddr:	192	·	168	·	13	·	216	File
Gateway:	192	·	168	·	13	·	1	Tool
Netmsk:	255	·	255	·	255	·	0	
MATH	FILT							2023/03/14 15:37:00

- Port
 - Set the port number for LAN
- IP Address (IPAddr)
 - Set the IP address for LAN
- Gateway
 - Set the gateway for LAN
- Net Mask (Netmsk)
 - Set the subnet mask for LAN

4.8.3 USB

EnviSys	BusSys	SetSys	Handler	Meas				
Mode:	USB	Addr:	1	Set				
TYPE:	CDC			Syst				
				File				
				Tool				
MATH	FILT							2023/03/14 15:37:17

- Mode

Set the USB mode.

CDC ---- set the USB mode to CDC

TMC ---- set the USB mode to TMC

NOTE: After changing the USB mode, the instrument needs to be restarted to be effective for use.

4.9 SetSys

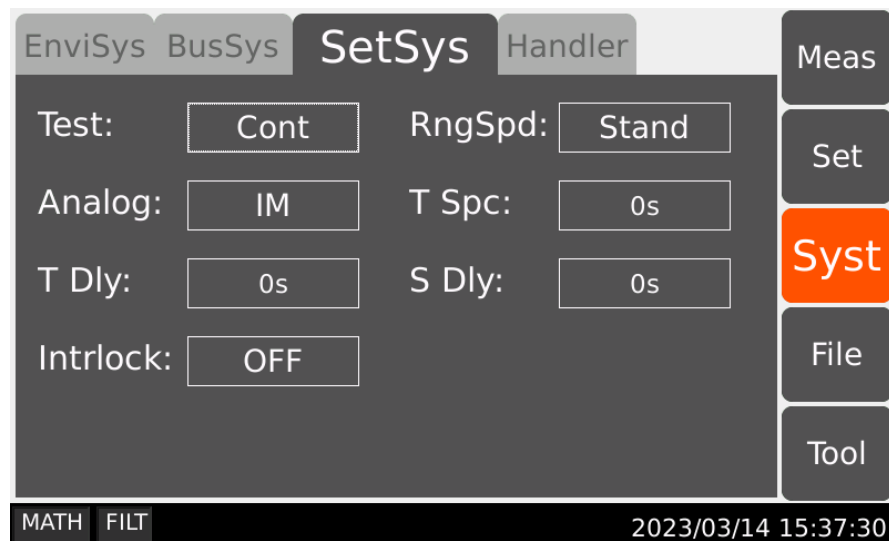

- Testing Mode (Test)

Set the testing mode.

Cont---- The instrument performs measurements continuously after pressing the Run/Stop key.

Single ---- The instrument performs a single measurement after pressing the Run/Stop key.

- Ranging Speed

Set the range speed for the instrument.

Stand ---- Standard ranging speed

Quick---- Less ranging waiting time

- Analog

Set the analog output parameter on the rear panel of the instrument.

IM ---- current (or charge) as analog output

VM ---- voltage as analog output

- T Spc

Set the time interval between two tests when the instrument is tested continuously.

- T Dly

Set the delay time for the instrument measuring.

- S Dly

Set the delay time for starting the voltage source.

- Interlock

Switch to toggle On/Off Interlock

ON ---- When the output voltage is greater than 20V, required to short the interlock switch

OFF ---- When the output voltage is greater than 20V, not required to short the interlock switch

4.10 Handler

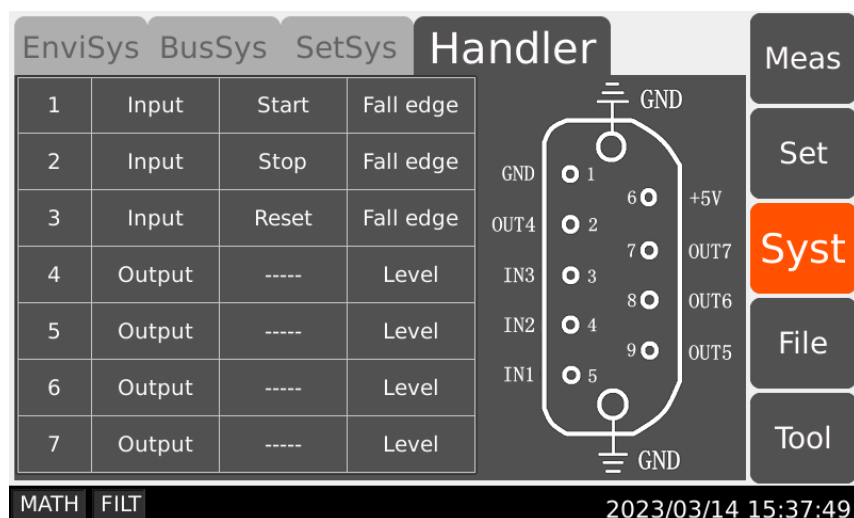

- Input

Slots 1, 2 and 3 are for signal input, corresponding to IN1, IN2 and IN3 in the figure above. The signal definition can be changed.

Start ---- Start testing

Stop ---- Stop testing

Reset ---- Reboot the instrument, reset

ScrOn ---- Voltage Source On

ScrOff ---- Voltage Source Off

ScrTri ---- Trigger Voltage Source Waveform Output

- Output

Slots 4, 5, 6 and 7 are for signal output, corresponding to OUT4, OUT5, OUT6, and OUT7 in the figure above. The signal output mode can be changed.

Level ---- Level output as signal output.

Pulse ---- Pulse signal (10ms) as signal output.

4.11 File

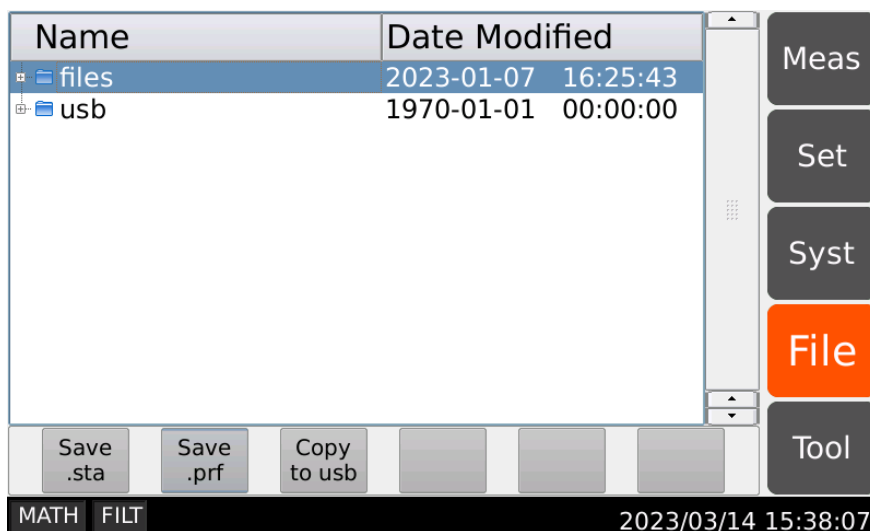

In the file interface, users can save the loading parameters (.sta) or system parameters (.prf); delete and copy the internal files or USB files of the instrument.

4.12 Tool

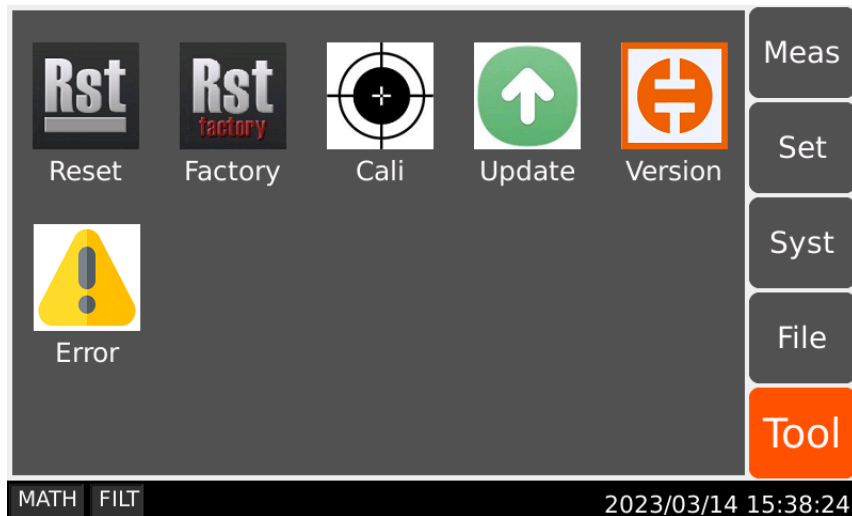

- Reset

This function is used to initialize the instrument to factory settings, reset all parameters, and automatically restart the instrument

- Cali

This function is used to self-calibrate the voltage plate and test plate

- Update

This function is used to update all the softwares of the instrument.

- Version

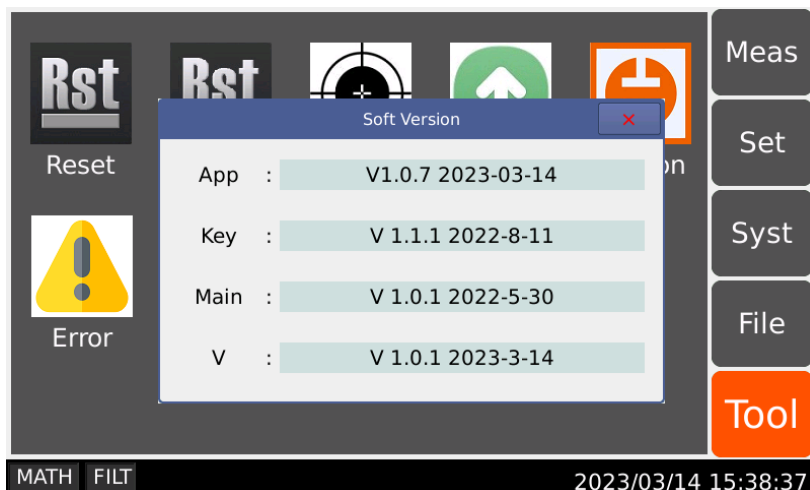

Display information about instrument version

- Error

Error message pops up when operation errors or self-test errors occur. Check the errorcode and eliminate the errors by following the prompts.

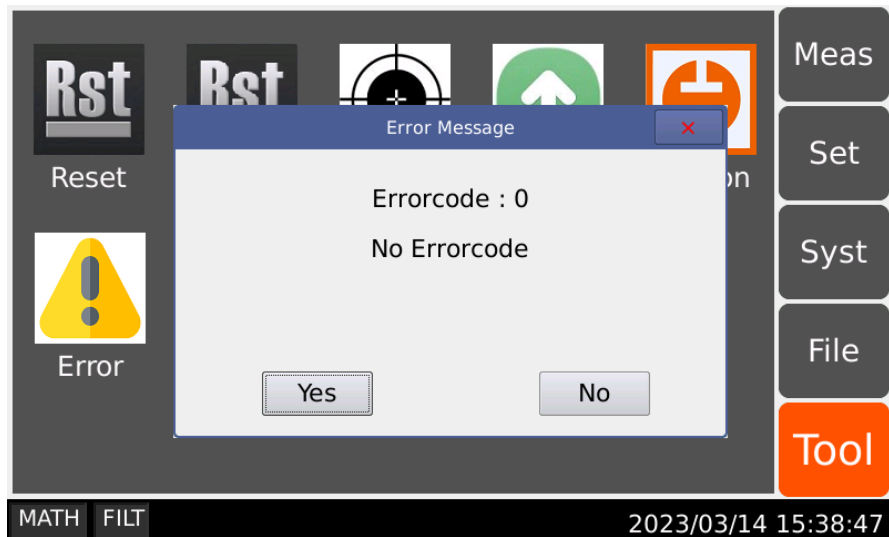

Error Code	Code Description
0	
1	Error sending command data
2	CRC check error
3	V Board self-check 1V error
4	V Board self-check 1V error
5	V Board self-check high voltage error
6	V Board HV_V alert, check for potential overloading
7	V Board LV_I alert, check for potential overloading
8	V Board OPA_TEMP alert, check for potential overheating
9	V Board HV_I alert. check for potential overloading
10	Main Board self-check AD error
11	Main Board U606-Pro, check whether the ammeter input is too large
12	Main Board U6-Pro, ammeter error
13	Main Board U7-Pro, ammeter error
14	Main Board U607-Pro, check whether the ammeter input is too large.
16	
17	
18	
19	
20	Error returning data

Chapter 5 Instrument Measurements and Instructions

5.1 Current Measurement

TH2690/TH2690A/TH2691/TH2691A supports current measurement as shown in figure 5-1:

Table 0-1 Current Measurement Range, Value, and Resolution

Range value	Measurement value	Display resolution
20mA	0~±21 mA	10 nA
2mA	0~±2.1 mA	1 nA
200 μA	0 ~±210 μA	100 pA
20 μA	0~± 21 μA	10 pA
2 μA	0 ~±2.1 μA	1 pA
200 nA	0 ~±210 nA	100 fA
20 nA	0 ~±21 nA	10 fA
2 nA	0 ~±2.1 nA	1 fA
200 pA	0 ~±210 pA	1 fA
20 pA	0 ~±21 pA	1 fA

5.1.1 Requirements

Before turning the instrument on, connect cable, test leads, test fixture, and so on, used for the measurement. See Figures 5-2 and 5-3 for connection examples.

The following accessories can be used.

- Triaxial cable, 200V, 1.5m
- Triaxial bulkhead connector, if needed.
- Φ 4 banana plug cable, for connecting Common to chassis ground.

Instead of the triaxial cable and the triaxial bulkhead connector, Triaxial to alligator clip cable, 200 V, 1.5 m can be used. When turning the instrument on, leave the end of the

measurement path open.

Figure 0-1 Simplified Circuit Diagram of Ammeter

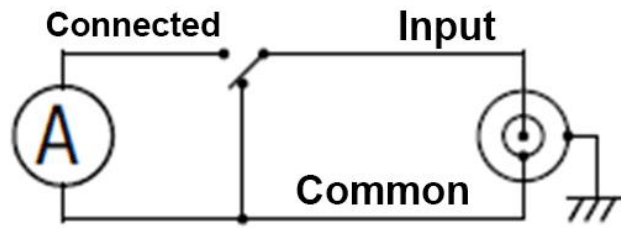

Figure 0-2 Current Measurement Connection, Grounded, Typical

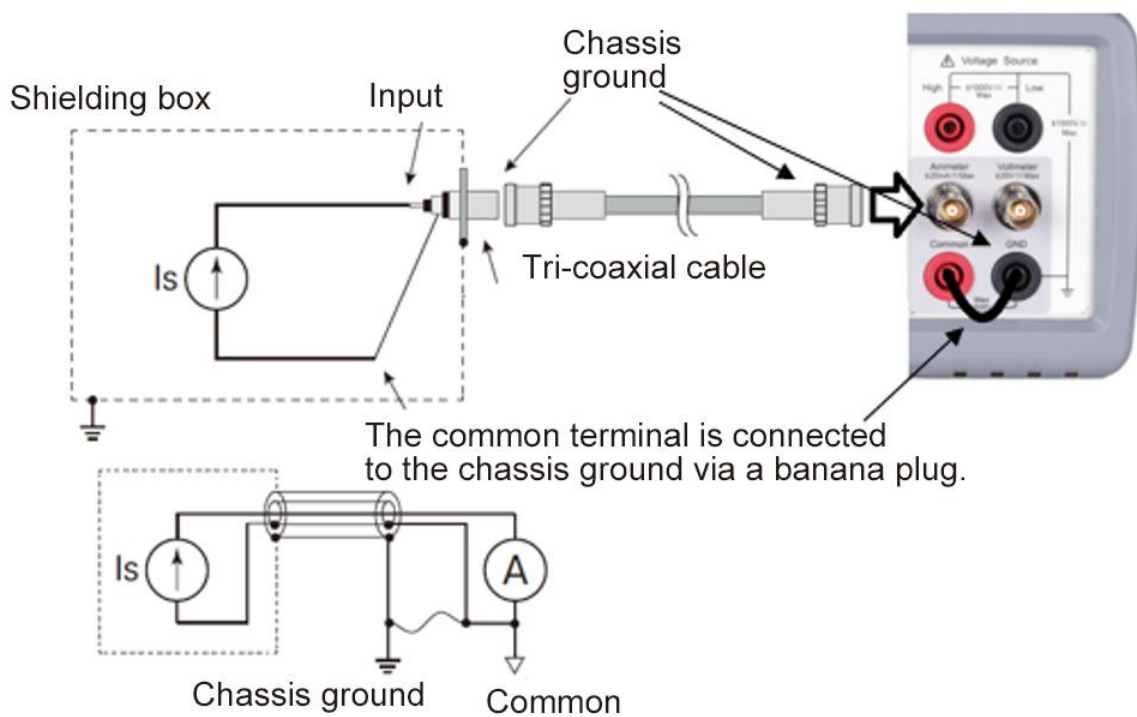
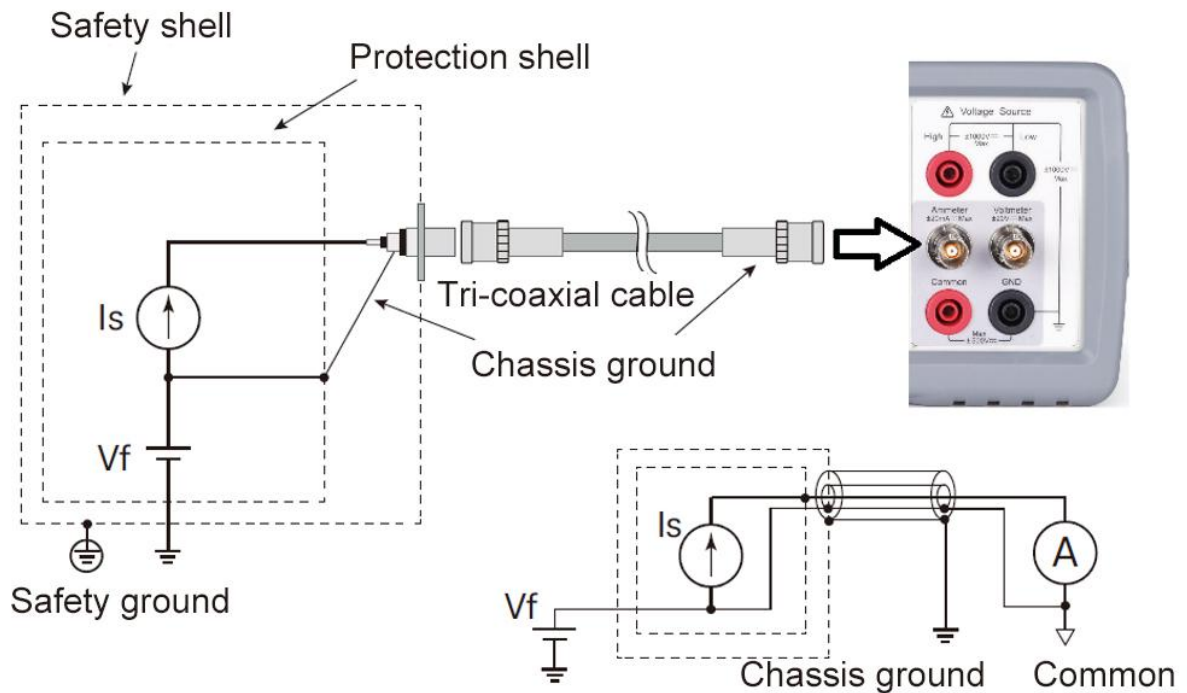

Figure 0-3 Current Measurement Connection (if DUT has a non-ground potential)



NOTE: For floating the ammeter, do not connect any cable between Common and chassis ground. See “[Common Terminal Connection](#)”

5.1.2 Procedure

You can perform the current measurement as the following.

Step 1. For the TH2690/TH2690A, press the Func key to choose current measurement mode.

Step 2. Set the measurement range on the display screen.

Step 3. Set the measurement speed on the display screen.

Step 4. Open the Measure Filter dialog box and set the measurement filter on the dialog box.

Step 5. Connect measurement current (DUT).

See Figure 5-2 for the typical current measurement.

See Figure 5-3 if DUT has a non-ground potential.

Step 6. Press the **Ammeter** key to enable Ammeter. This turns the switch green.

Step 7. Press the **Run/Stop** to start the measurement (contineous/single).

Step 8. Press the **Ammeter** key to disable Ammeter. This turns off the switch light.

For more precise measurement, use the zero correction or offset cancel.

5.1.3 Setup Parameters

Parameters settings for reference see-[Voltmeter Settings](#).

5.1.4 Common Terminal Connection

The Common terminal is internally connected to the common of Ammeter, Analog Out, and Voltmeter. This terminal is used as the reference terminal for input/output of them.

For the measurement of the device which has a non-ground potential, the Common terminal must be connected to chassis ground by using a Banana-to-Lug cable (furnished) or equivalent. In this condition, the current/voltage measurement that refers to ground as reference is performed.

For the measurement of the device which has the ground potential, do not connect any cable between Common and chassis ground to make the Ammeter/Voltmeter floating. This situation causes a potential difference between the input of the ammeter and the earth (Ground), and in weak current measurements, this potential difference may cause leakage currents and thus errors. The use of protection techniques can eliminate this error.

Figure 0-4 Protection Technique

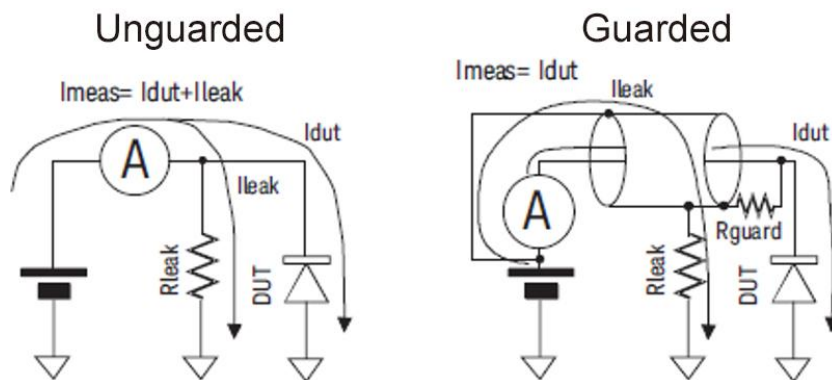

If a dielectric exists between the Input of Ammeter and the other potential, the leakage current flows in accordance with a potential difference and resistance. Guarding technique covers the wire connecting from the Input of Ammeter with a conductor (Guard) that has same potential as Input to cancel the potential difference from the surrounding dielectric so that the leakage current can be reduced. Because the Common and Input of Ammeter have almost same electric potential, connect the guard to the Common. In the unprotected case (Figure 5-4 left), I_{leak} causes errors. In the protected case (Figure 5-4 right), I_{leak} does not flow through the ammeter and does not affect the measurement. If the potential difference between the two ends of the R_{guard} is 0, no leakage current will flow there.

WARNING: If the Common terminal is not connected to chassis ground, voltage of up to ± 500 V can be applied to the Common terminal. To prevent electrical shock, do not touch any of measurement circuit at any time while a floating measurement is in progress. Also use accessories that comply with IEC. All terminals and the extended conductors must be isolated by using insulation caps, sleeves, etc.

CAUTION: Do not apply current to the chassis ground. Doing so will damage the instrument.

5.2 Voltage Measurement

The TH2690/TH2690A supports the voltage measurement capability shown in Table 5-2.

Table 0-2 Voltage Measurement Range, Value, and Resolution

Range value	Measurement value	Display resolution
20V	0~±21 V	10 uV
2V	0~±2.1V	1 uV

5.2.1 Requirements

Before turning the instrument on, connect cable, test leads, test fixture, and so on, used for the measurement. See Figures 5-6 and 5-7 for connection examples.

The following accessories can be used.

- Triaxial cable, 200 V, 1.5 m
- Triaxial bulkhead connector, if needed
- Banana to alligator clip cable, for connecting Common to voltage under test low
- Banana to lug cable, for connecting Common to chassis ground

Instead of the triaxial cable and the triaxial bulkhead connector, Triaxial to alligator clip cable, 200 V, 1.5 m can be used. When turning the instrument on, leave the end of the measurement path open.

Figure 0-5 Simplified Circuit Diagram of Voltmeter

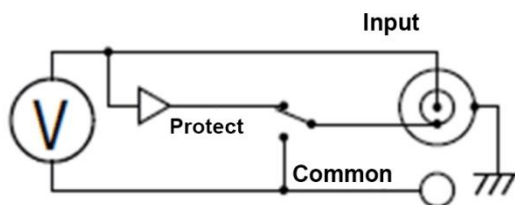

NOTE: Voltmeter connector's inner shield is internally connected to Guard or Common as shown in Figure 5-5. The internal connection must be made properly. It must be connected to Guard for the guarded voltage measurement. And it must be

connected to Common for the unguarded voltage measurement. Incorrect setup causes measurement errors. See [“Guarded and Unguarded Connections”](#) for more information.

Figure 0-6 Guarded Voltage Measurement Connections

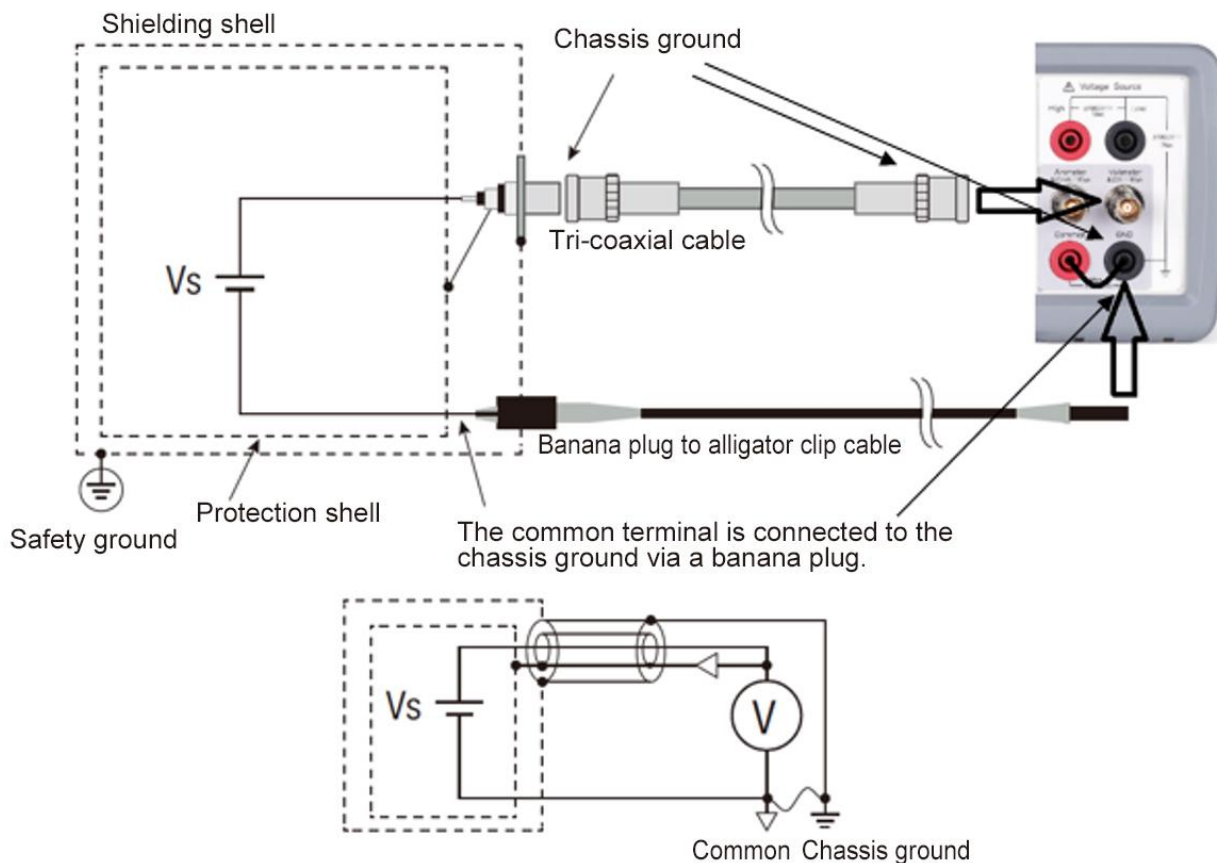
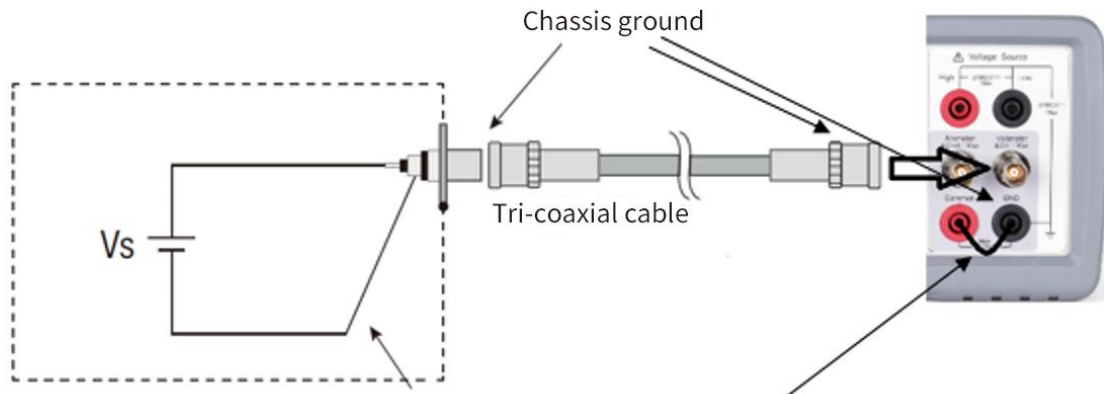
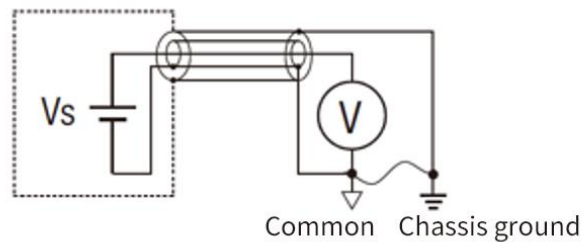

Figure 0-7 Unguarded Voltage Measurement Connections



The common terminal is connected to the chassis ground via a banana plug.



Instead of connecting the inner shield (Common) of Voltmeter, a banana to alligator clip cable can be used for connecting Common to low terminal of voltage under test.

NOTE: For floating voltmeter, do not connect any cable between Common and chassis ground. See “[Common Terminal Connection](#)” for more information.

5.2.2 Procedure

You can perform the voltage measurement as follows.

Step 1. Press the **Func** key to choose the voltage measurement mode.

Step 2. Set the measurement range on the display screen.

Step 3. Set the measurement speed on the display screen.

Step 4. Connect measurement voltage (DUT).

See figure 5-6 for the guarded voltage measurement.

See figure 5-7 for the unguarded voltage measurement.

Step 5. Press the **Run/Stop** key to start the measurement. (continuous /single).

For more precise measurement, use the zero correction or offset cancel.

NOTE: The TH2690/TH2690A may show the voltage around 4V or OVERFLOW just after turning on or during the voltage measurement. This is caused by the internal circuit when the voltmeter input is open. This operation is normal, not failure

5.2.3 Setup Parameters

Parameters settings for reference see [-Voltmeter Settings](#).

5.2.4 Guarded and Unguarded Connections

Voltmeter input is a triaxial connector. The center conductor and the outer shield are connected to the voltmeter input and the chassis ground respectively. And the inner shield must be connected to Guard for the guarded voltage measurement or Common for the unguarded voltage measurement.

To make this internal connection, open the Input Connection dialog box by pressing the Set-MeasSet-Voltmeter and set the Voltage Measure Inner Shield field properly. The following options are available.

- GUARD

Inner shield is connected to Guard. It is the connection method for making protected voltage measurements, which gives more accurate measured values. Guarded voltmeter indicator turns on.

- CCOM

Inner shield is connected to Common. It is the connection method for unguarded voltage measurement, which is much easier. Guarded voltmeter indicator turns off.

Figure 0-8 Difference between GUARD and COMMON

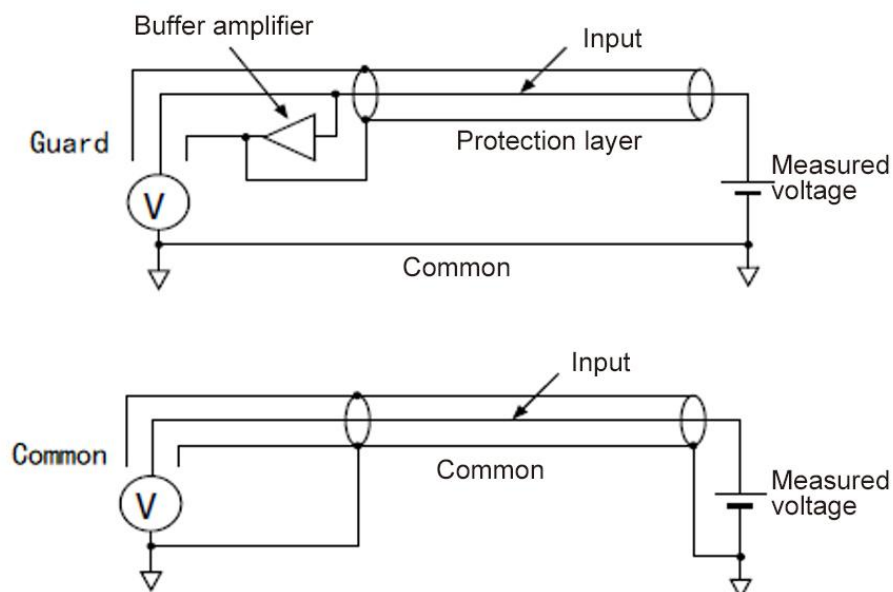

5.2.5 Guarding

Guarding is effective when a voltage source under test has the high output resistance.

Figure 5-9 shows the theory of guarding. If the guard is not used, the inner shield of triaxial cable has Common potential and the same voltage as the measured voltage is applied between center and inner conductors. The insulation resistance of cable is a finite value, so the voltage divided by the ratio of the output resistance of voltage source under test to the insulation resistance of cable is measured.

Also, there is an electrostatic capacitance between the inner shield and the center conductor of triaxial cable, so the measured voltage is settled according to the time constant determined by the electrostatic capacitance and the output resistance. If the output resistance is too large, the settling may require the longer time.

If the guard is used, the buffer amplifier keeps the potential of the inner shield at the same potential as the center conductor of triaxial cable. So, the voltage is not applied between both end of insulation resistance and capacitance of cable, and these affect can be ignored. Therefore, you can make the precise and fast measurement even for the voltage source under test that has the large output resistance.

Figure 0-9 Guarding

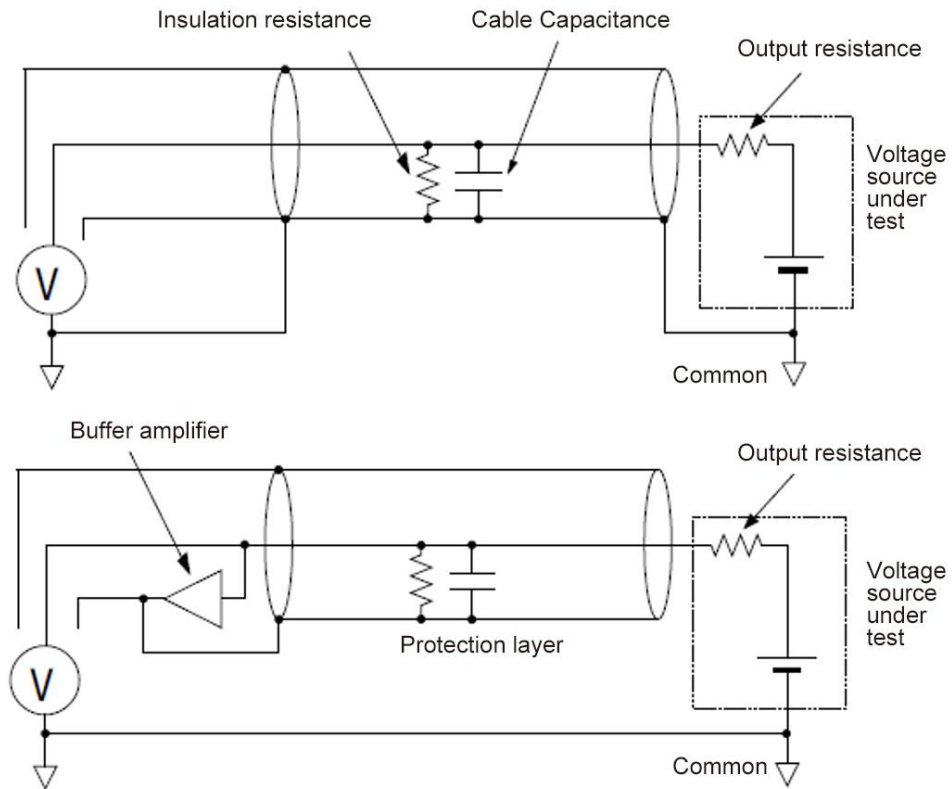

CAUTION: Never connect the Guard terminal to any output, including circuit common, chassis ground, or any other guard terminal. Doing so will damage the instrument.

5.3 Resistance Measurement

TH2690 supports the resistance measurement up to 1000 P Ω (reference value); the TH2690A supports the resistance measurement up to 10 P Ω (reference value).

TH2690 series supports the resistance measurement capability shown in Table 5-3.

Table 0-3 Resistance Range, Value, and Resolution

Range value	Current range used for measurement	Output value set to voltage source	Measurement value	Display resolution
1M Ω	200 μ A	20V	$\geq 100\text{k}\Omega$	1 Ω
10M Ω	20 μ A		$\geq 1\text{M}\Omega$	10 Ω
100M Ω	2 μ A		$\geq 10\text{M}\Omega$	100 Ω
1G Ω	200nA		$\geq 100\text{M}\Omega$	1k Ω
10G Ω	20nA		$\geq 1\text{G}\Omega$	10k Ω
100G Ω	2nA		$\geq 10\text{G}\Omega$	100k Ω
1T Ω	2nA	200V	$\geq 100\text{G}\Omega$	1M Ω
10T Ω	200pA		$\geq 1\text{T}\Omega$	10M Ω
100T Ω	20pA		$\geq 10\text{T}\Omega$	100M Ω
Manuel	Auto or locked	Manuel		

5.3.1 Requirements

Before turning the instrument on, connect cable, test leads, test fixture, and so on, used for the measurement. See Figure 5-10 and 5-11 for connection examples.

The following accessories can be used.

- Triaxial cable, 200 V, 1.5 m
- Triaxial bulkhead connector, if needed
- High voltage test lead, 1000 V, 1.5 m, for High terminal
- Banana to lug cable, for connecting Common to chassis ground
- Banana to banana cable, for connecting Voltage Source High to Common

- High resistance measurement universal adapter

Instead of the triaxial cable and the triaxial bulkhead connector, a Triaxial to alligator clip cable, 200 V, 1.5 m can be used. When turning the instrument on, leave the end of the measurement path open.

Figure 0-10 Floating Device Measurement

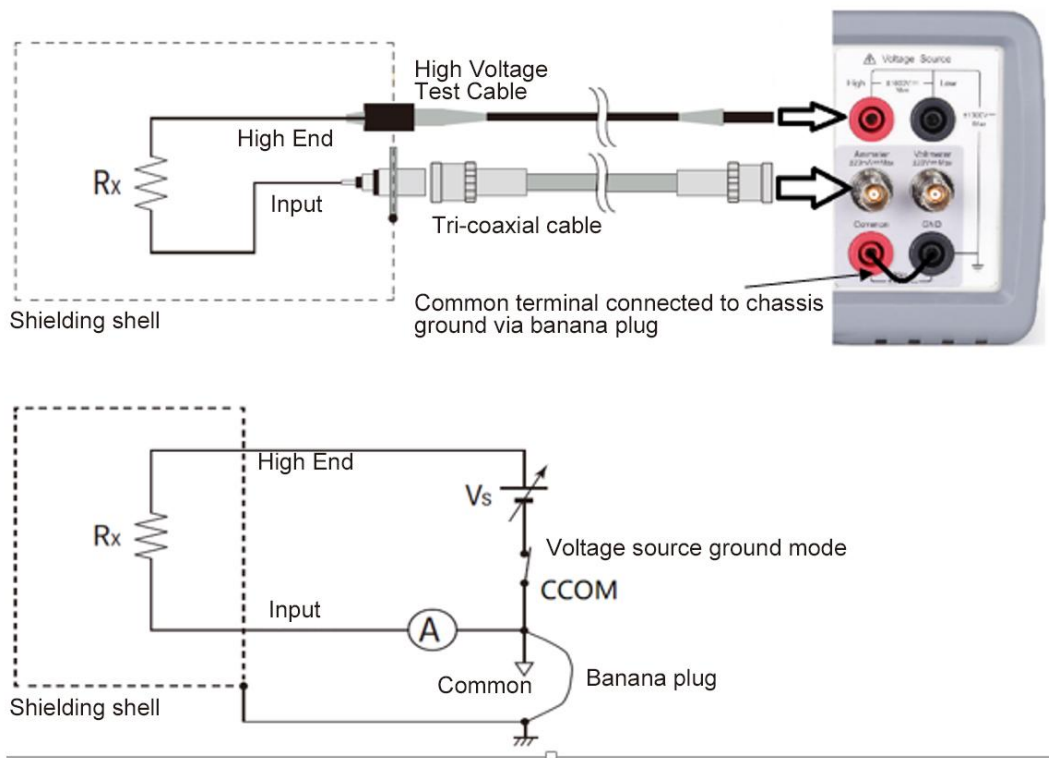

NOTE: To apply a voltage over $\pm 21V$, the interlock terminal must be connected to an interlock circuit. See [“Installing the Interlock Circuit”](#).

NOTE: Voltage Source Low terminal is internally connected to or disconnected from the circuit common as shown in Figure 5-10. See “Low Terminal State” for more information.

Figure 0-11 Grounded Device Measurement

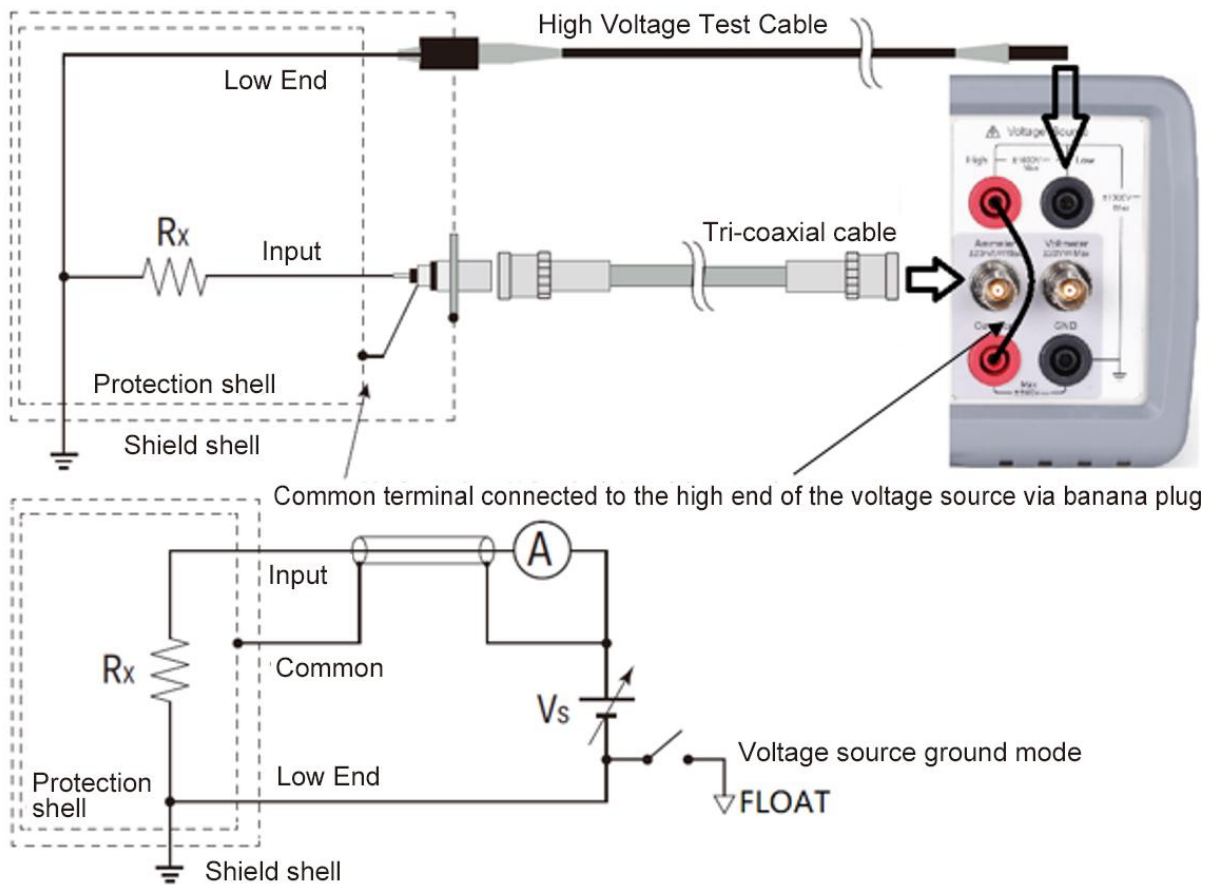

NOTE: The connection shown in Figure 5-11 applies the voltage to the Common terminal from the Voltage Source. The voltage up to $\pm 500V$ can be applied to the Common terminal.

NOTE: Voltage Source Low terminal is internally connected to or disconnected from the circuit common as shown in Figure 5-11. See "[Low Terminal State](#)" for more information.

5.3.2 Procedure

You can perform the resistance measurement as follows

Step 1. Set the resistance calculation mode, V_s/I_m or V_m/I_m .

Step 2. Press the **Func** key to select the resistance measurement mode.

Step 3. Set the current measurement range and the output voltage. If the resistance range is not set to manual, set the resistance range. Set the measurement range on the

display screen.

Step 4. Set the desired measurement speed on the display screen.

Step 5. Connect resistor (DUT) to measure. See Figure 5-10 and 5-11 for the connection.

Step 6. Press the **Ammeter** key to enable Ammeter. This turns the switch to green.

Step 7. Press the **Source** key to enable the voltage output. This turns the switch green, and the voltage source starts output.

Step 8. Press the **Run/Stop** key to start a repeat (continuous) measurement. Resistance measurement is performed repeatedly. Minimum measurement interval is 10 ms.

Step 9. Press the **Source** key to disable the voltage output. This turns off the switch light.

Step 10. Press the **Ammeter** key to disable Ammeter. This turns off the switch light.

NOTE: To perform voltage source waveform output measurement, settings under Set-SrcSet.

5.3.3 Resistance Calculation Mode

Resistance measurement value is calculated by the formula, $R=V_s/I_m$ or $R=V_m/I_m$. Where, V_m is measurement voltage, I_m is measurement current, and V_s is output voltage. The mode can be specified under Set-MeasSet-High Res. When range is not set to manual, only V_s/I_m is available.

5.3.4 Choosing Range for High Resistance Meter

Auto and manual mode are available for the measurement range for high resistance meter, see Table 5-3.

In Manual mode, external power supply can be used to measure the voltage and current of the unit under testing. Resistance calculation mode is $R=V_m/I_m$, it is required to configure the voltage measurement range and the current measurement range.

In Auto mode, auto resistance range is available. The instrument will automatically

choose the range of the best fit for measurement. A fixed range is also available for saving the measurement time.

5.3.5 Low Terminal State

Voltage Source Low terminal is internally connected to or disconnected from the circuit common. To make this internal connection, please set the GND field properly under Set-MeasSet-V source

The following values are available

- CCOM Low terminal is internally connected to the circuit common. Floating indicator turns off.
- FLOAT Low terminal is internally disconnected from the circuit common.

Floating indicator turns on.  This setting is used when applying voltage to the Common terminal.

CAUTION: Although the Low terminal is set to FLOATING, the High potential and the Low potential must be less than or equal to $\pm 1000\text{V}$ for chassis ground. The output voltage is limited to $\pm 1000\text{V}$ even if the Voltage Source makes the cascade connection with an external voltage source.

NOTE: When the both Low and Common terminals are in the floating condition, the potential of the Common terminal must be between the Low potential and the High potential. And it must be less than or equal to $\pm 500\text{V}$ for chassis ground.

5.4 Charge Measurement

TH2690 supports the charge measurement capability shown in Table 5-4. The coulomb meter uses the ammeter terminal as input terminal.

Table 0-4 Charge Measurement Range, Value, and Resolution

Range value	Measurement value	Display resolution
2 nC	0 ~ ± 2.1 nC	1 fC

20 nC	0 ~ ±21 nC	10 fC
200 nC	0 ~ ±210 nC	100 fC
2 µC	0 ~ ±2.1 µC	1 pC

5.4.1 Requirements

Before turning the instrument on, connect cable, test leads, test fixture, and so on, used for the measurement. See Figure 3-2 for connection examples.

The following accessories can be used.

- Triaxial cable, 200 V, 1.5 m
- Triaxial bulkhead connector, if needed
- Banana to lug cable, for connecting Common to chassis ground

Instead of the triaxial cable and the triaxial bulkhead connector, a Triaxial to alligator clip cable, 200 V, 1.5 m can be used.

NOTE: When turning the instrument on, leave the end of the measurement path open.

NOTE: For floating the coulomb meter, do not connect any cable between Common and chassis ground. See "[Common Terminal Connection](#)" for more information.

Figure 0-12 Charge measurement connection

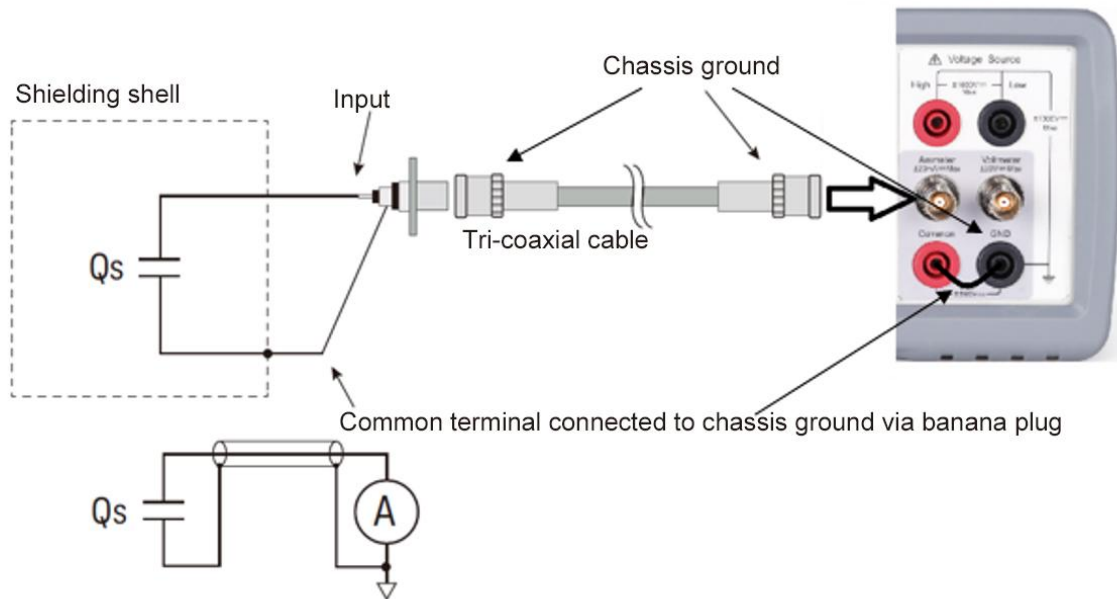

5.4.2 Procedure

You can perform the charge measurement as follows.

Step 1. Set the automatic discharge function.

Step 2. Press the **Func** key to select the charge measurement mode.

Step 3. Set the charge measurement range on the display screen.

Step 4. Set the desired measurement speed on the display screen.

Step 5. Open the Filter dialog under ConfSet, then set the filter.

Step 6. Connect the measurement charge (DUT) to the Ammeter input connector. See Figure 5-12 for the connection.

Step 7. Press the **Ammeter** key to enable the coulomb meter. This turns the switch green.

Step 8. Press the **Run/Stop** key to start measuring. The minimum measurement interval is 10ms.

Step 9. Press the **Ammeter** key to disable the coulomb meter. This turns off the green switch light.

For more precise measurement, use the zero correction or offset cancel.

5.4.3 About Charge Measurement

The coulomb meter can measure charges with the wide range from the minimum range 2 nC (resolution: 1 fC) to the maximum range 2 μ C (resolution 1 pC). The input amplifier circuit of the coulomb meter has a capacitor in the feedback loop so that its voltage is proportional to the integral of the input current. The capacitance value is known and accurate. And the capacitance C, charge Q_s , and voltage V are expressed by the following formula.

$$V = \frac{1}{C} \int i dt = \frac{Q_s}{C}$$

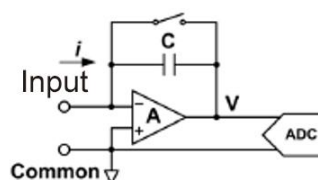

5.4.4 Automatic Discharge

The automatic discharge function is effective for preventing the coulomb meter from range overflow. If this function is enabled, the coulomb meter resets the charge when the charge reaches the specified level. After resetting, the charge measurement restarts. This function is enabled/disabled under Set-MeasSet-Electrometer.

5.4.5 Discharge Level

When Automatic Discharge is enabled, the discharge level can be selected from 2 nC, 20 nC, 200 nC, or 2 μ C under Set-MeasSet-Electrometer.

5.5 Voltage Source

TH2690/TH2690A supports the voltage source measurement capability shown in Table 5-5.

Table 5-5 Voltage Output Range, Value, Resolution, and Maximum Current

Range value	Measurement value	Display resolution	Maximum Current
20V	$-20 \leq V \leq 20$	700 uV	± 20 mA
1000V	$0 \leq V \leq 1000$	35mV	± 1 mA
-1000V	$-1000 \leq V \leq 0$		

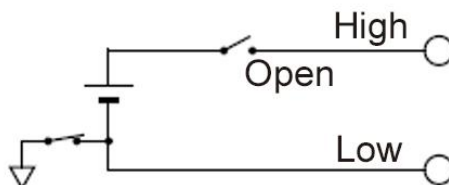

5.5.1 Procedure

You can perform the voltage source DC output as follows

Step 1. Set the output type under Set-SrcSet.

Step 2. Output DC when VS Func under Set-SrcSet is off.

Step 3. Set the voltage source range under Set-MeasSet-V source.

Step 4. Set the voltage source output value.

Step 5. Press the Source key, turn on VS Func, this turns the switch green (or red), voltage source starts output.

Step 6. Press the Source key, turn off VS Func, this turns the switch light off, voltage source stops output.

You can also perform the voltage source waveform output as follows

Step 1. Set the output type under Set-SrcSet

Step 2. Set each parameter, see details in Chapter 4.

Step 3. Press the Source key, turn on VS Func, this turns the switch green. The instrument selects voltage source output range automatically, and standby.

Step 4. Under Syst-Handler, define a pin input as the source trigger, when the pin

position is low, the instrument starts sweep output (When the source trigger mode is trigger, it performs a single sweep every time it triggers).

Step 5. Press the Source key, turns off the voltage source, this turns of the switch light, and the voltage source stops output.

5.6 Temperature and Humidity Measurement

TH2690/TH2690A supports temperature and humidity measurement capability.

With the factory default setting, the TH2690/TH2690A will measure temperature and humidity if the sensor is connected properly. The instrument will measure and record every other 10s and displays them on the Measurement interface.

Table 0-5 Temperature and Humidity Measurement range

	Temperature	Humidity
Measurement Range	40 C to 80 C	0 % to 100 %

5.6.1 Requirement

Before turning the instrument on, connect accessory used for the measurement. See Figure 5-13 for connection.

The following accessories can be used.

- Temperature and humidity sensor, ASAIR AM2105A or equivalent.
- Connector head, MPC300-250-3P or equivalent, used for sensor connection.

5.6.2 Preparation for connecting humidity sensor

Connect the connection cable to the connector head. See Figure 5-13 for the connector head pin numbers and the coating colors of cable wire.

To connect the cable to the connector head, just insert the corresponding wire into the appropriate wire hole of the connector head.

If the wire can be removed easily due to a slippery pin of wire tip, cut off the pin and strip the coating of the tip. Then, retry insert.

If you made a wrong connection, remove the wire and retry insert. You can remove the

wire by pushing the associated button (orange) and pulling the wire.

Figure 0-13 Temperature and Humidity Measurement Connection

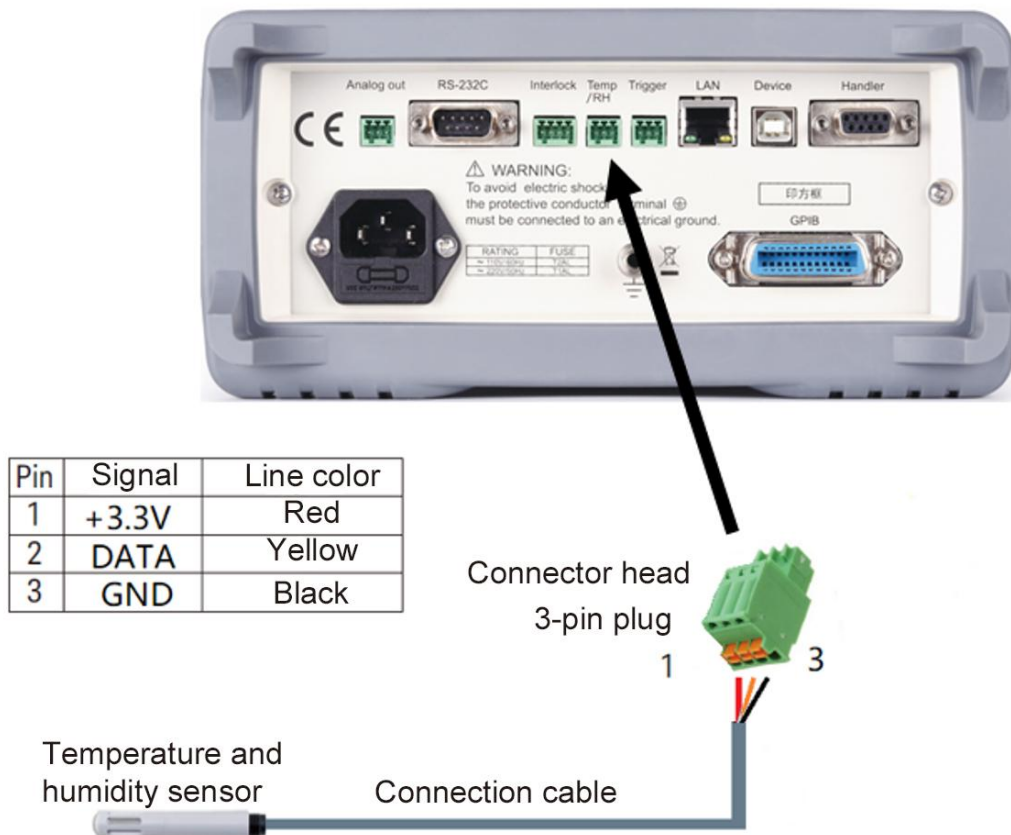

5.7 Installing the Interlock Circuit



This section is applied to Tonghui TH2690/TH2690A which supports the interlock function. The interlock circuit is a simple electric circuit, as shown in Figure 5-14. The circuit electrically opens when an access door is opened, and closes when the door is closed.

TH2690/TH2690A cannot apply high voltages over ± 21 V when the interlock terminal is open. To apply high voltage, the TH2690/TH2690A interlock terminal must be connected to the interlock circuit installed in the measurement environment such as the shielding box. The interlock circuit is important and necessary to prevent electrical shock when the user touches the output terminal.

WARNING: Potentially hazardous voltages of up to ± 1000 V may be present between the High and Low terminals of the Voltage Source when the interlock

circuit is closed. To prevent electrical shock, do not expose the line.

5.7.1.1 Requirements

- LED, 1 ea.
- Mechanical switch, 2 ea.
- Interlock connector head, 4-pin plug, 1 ea, furnished, MPC300-250 (4 pin) or equivalent.
- Connection wire, needs enough length from the shielding box to the interlock connector on the TH2690/TH2690A rear panel.

5.7.1.2 Procedure

1. Mount two mechanical switches onto your shielding box, so that the switches close when the access door is closed and open when the door is opened.

2. Mount an LED onto the shielding box.

The LED is used as a high voltage indicator which is lit when the TH2690/TH2690A is in the high voltage output status over $\pm 21V$.

3. Use a wire and connect the two switches in series between the pins 3 and 4 of the Interlock connector head.

To connect the wire to the Interlock connector head, just insert the wire into the appropriate wire hole.

If you inserted the wire into a wrong hole, remove it and retry. You can remove the wire by pushing the associated button (orange) and pulling the wire.

4. Use a wire and connect the LED between the pins 1 and 2 of the Interlock connector head.

5. Connect the Interlock connector head to the Interlock connector on the TH2690/TH2690A rear panel.

Figure 0-14 Interlock Circuit

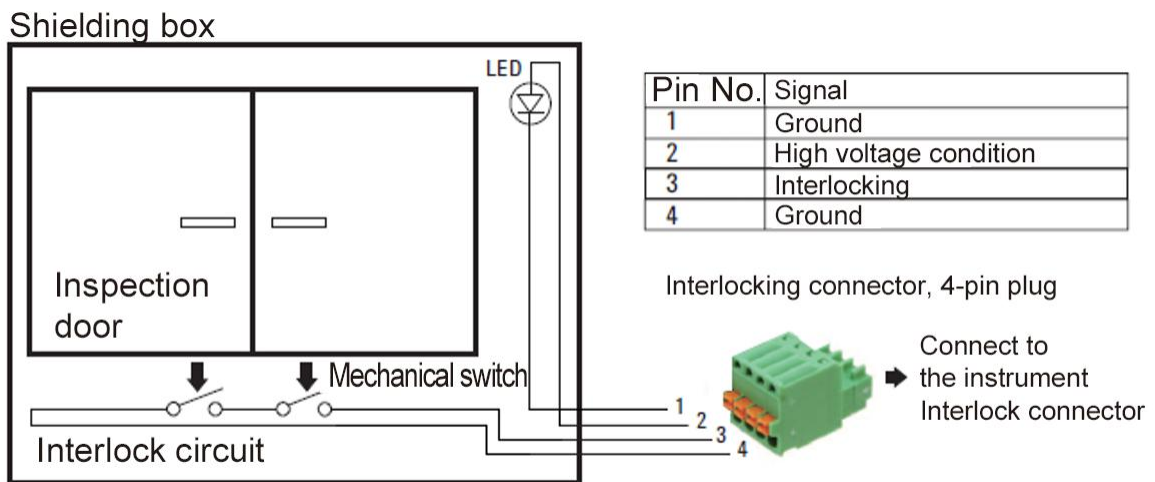

5.8 BIN Limit Test

This instrument supports limit sorting, it performs a pass/fail judgment for a measurement data or math result data by comparing with predefined test limit (upper and lower limit), then classifies the data using the results. Maximum of seven limit tests can be defined and used for the bins of composite limit test, and the results can be output via Handler. See Set-BINSet for more detailed settings.

5.8.1 Limit Mode

Limit tests are in two operation modes, Grading mode and Sorting mode.

5.8.1.1 Grading

Or hierarchical mode, can perform limit test for up to 12 test limits (bins), until a failure is detected, test stops and shows failed BIN number.

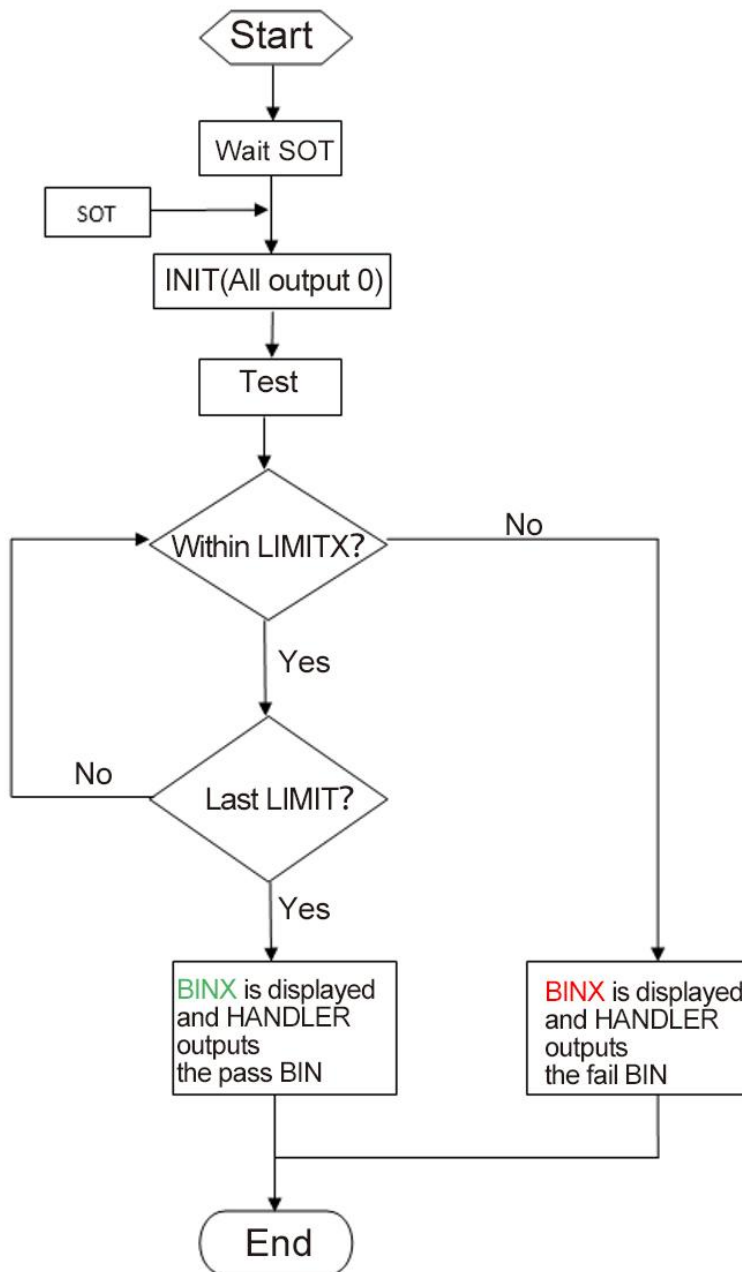

Example: Limit Test: On

Fail Interval: outside interval

BIN1 upper limit: 150M BIN1 lower limit: -150M

BIN2 upper limit: 15M BIN2 lower limit: -15M

BIN3 upper limit: 1.5M BIN3 lower limit: -1.5M

BIN4 upper limit: 150k BIN4 lower limit: -150k

BIN5 upper limit: 15k BIN5 lower limit: -15k

BIN6 upper limit: 1.5k

BIN6 lower limit: -1.5k

BIN7 upper limit: 150

BIN7 lower limit: -150

When the measured value is 10M, it is passed in BIN2 interval, failed in BIN3 interval. The instrument displays BIN3 (in red, indicating failure), and the HANDLER outputs the BIN3 fail pattern.

When the measured value is 1k, it is passed in BIN6 interval, failed in BIN7 interval. The instrument displays BIN7 (in red, indicating failure), and the HANDLER outputs the BIN7 fail pattern.

When the measured value is 100, it is passed in all 7 intervals. The instrument displays BIN7 (in green, indicating pass), and the HANDLER outputs the BIN7 pass pattern.

5.8.1.2 Sorting

Or classification mode, can performs up to 7 tests, stops when one passed test occurred, and displays the passed BIN number.

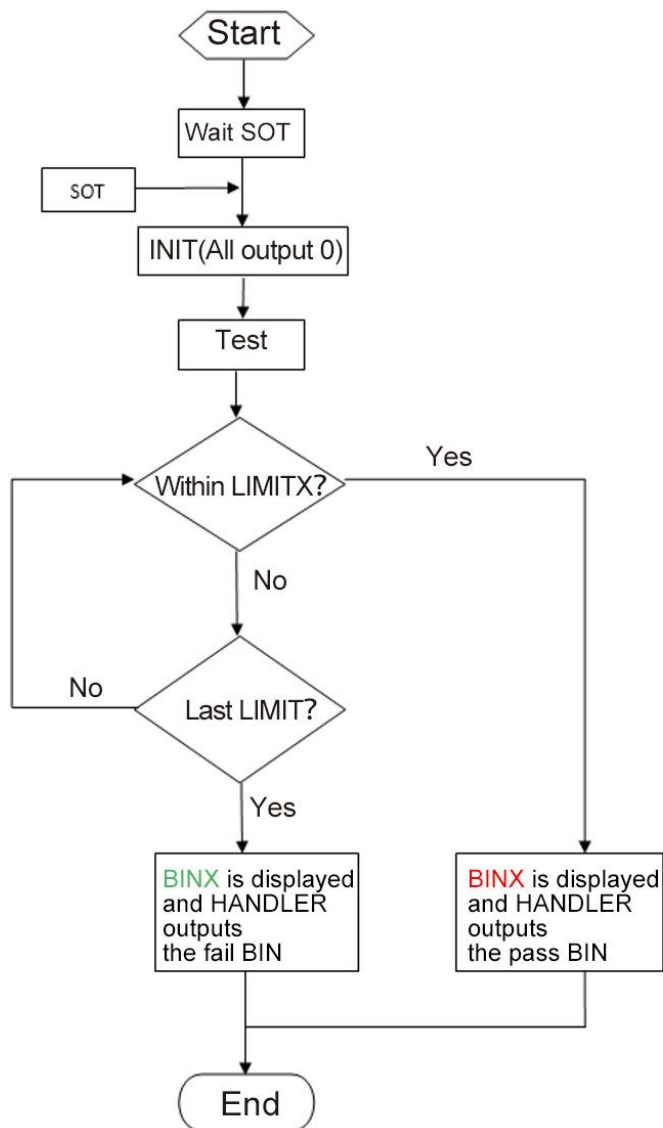

Example: Limit Test: On

Fail Interval: outside interval

BIN1 upper limit: 1.5k

BIN1 lower limit: -1.5k

BIN2 upper limit: 15k

BIN2 lower limit: -15k

BIN3 upper limit: 150k

BIN3 lower limit: -150k

BIN4 upper limit: 1.5M

BIN4 lower limit: -1.5M

BIN5 upper limit: 15M

BIN5 lower limit: -15M

BIN6 upper limit: 150M

BIN6 lower limit: -150M

BIN7 upper limit: 1.5G

BIN7 lower limit: -1.5G

When the measured value is 1k, it is passed in the BIN1 interval. The instrument displays BIN7 (in green, indicating pass), and the HANDLER outputs the BIN1 pass pattern.

When the measured value is 10M, it is passed in the BIN5 interval. The instrument displays BIN5 (in green, indicating pass), and the HANDLER outputs the BIN5 pass pattern.

When the measured value is 100G, it is failed in all 7 intervals. The instrument displays BIN7 (in red, indicating failure), and the HANDLER outputs the BIN7 fail pattern.

5.9 HANDLER Output

This instrument supports Handler function, with a DB-9P connector. It is possible to configure settings for each of the 7 pins. 3 pins for input, and 4 pins for output. As shown in the following figure, pin 5, 4, 3 of the DB-9P are corresponding to input 1(IN1), 2(IN2), 3(IN3); pin 2, 9, 8, 7 are corresponding to output 4(OUT4), 5(OUT5), 6(OUT6), 7(OUT7).

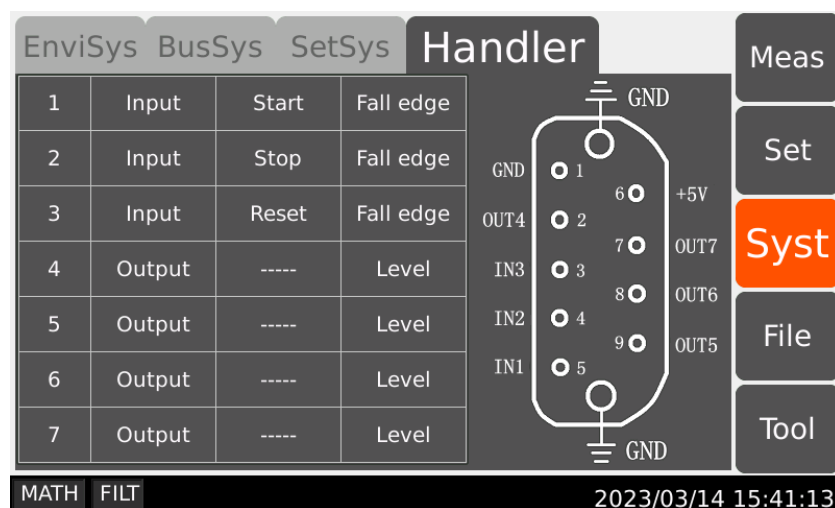

5.9.1 Set Input

The input can be used to define different functions: start measurement, stop measurement, reset, source off, source on, and source trigger (for voltage source waveform sweep).

5.9.2 Set Output

The output function is for the HANDLER limit tests results. The outputs can be set in levels or pulses.

Example: If the output result is pass 0010, then the HANDLER output is pin2 (4) -low,

pin9 (5)-low, pin8 (6)-high, pin7 (5)-low.

5.10 Use of TRIG IN/OUT

TH2690 also has connectors for trigger inputs/outputs. They are used to perform operations synchronized with external devices. The Trigger connectors make the connection easier than the Handler connectors.

5.10.1 Connection

TRIG connection is similar to temperature and humidity connector.

PIN	NAME	COLOR	DESCRIPTION
1	TRIG IN	BLACK	Receive TRIG signals (fall edge)
2	TRIG OUT	YELLOW	Send TRIG signals (low pulse)
3	GND	RED	GND

Press the orange button and then insert the exposed copper wire into the corresponding jack and into the rear panel:

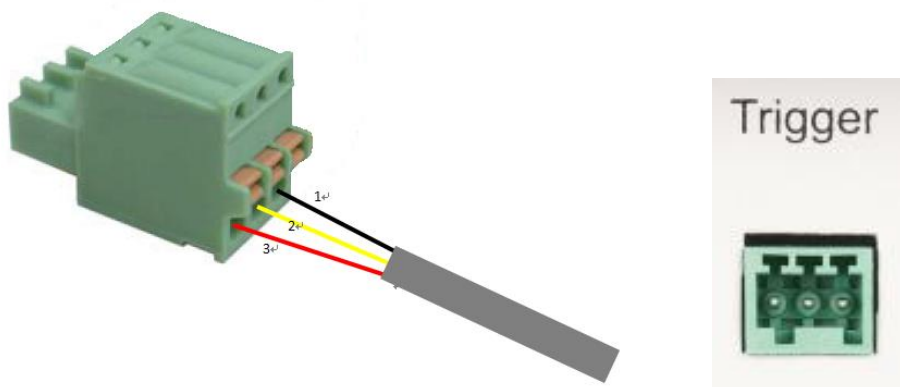

5.10.2 TRIG IN

When TRIG IN receives fall edge, it is equivalent of pressing the Run/Stop switch on the front panel, which starts or stops measurements (single/cont).

5.10.3 TRIG OUT

After receiving TRIG IN signal, TRIG OUT pin will output 20ms low pulse.

5.11 Voltage Source Waveform Output

The instrument voltage source can be DC output, single staircase sweep output, double staircase sweep output, square waveform output, list sweep output, in Set-SrcSet. When waveform output is set to off, the instrument outputs the preset voltage value, and the Source key on the front panel can be used to start the voltage output directly. When the VS function is selected, parameters need to be set first. Turn on Source, select SrcTrg in Handler-input field, to trigger output.

5.11.1 Single Staircase Sweep

Set and output waveform as shown in the following figure: Start to be 1V, Period to be 2s, Step 1V voltage every 2s, Stop when the voltage reaches 5V, and keeps it at 5V.

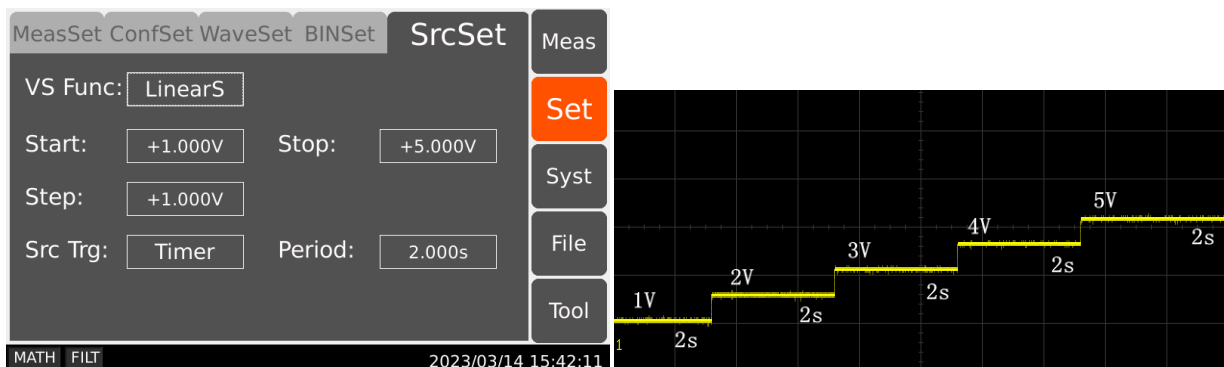

5.11.2 Double Staircase Sweep

Set and output waveform as shown in the following figure: the output is mirrored by a single staircase sweep into a double staircase sweep.

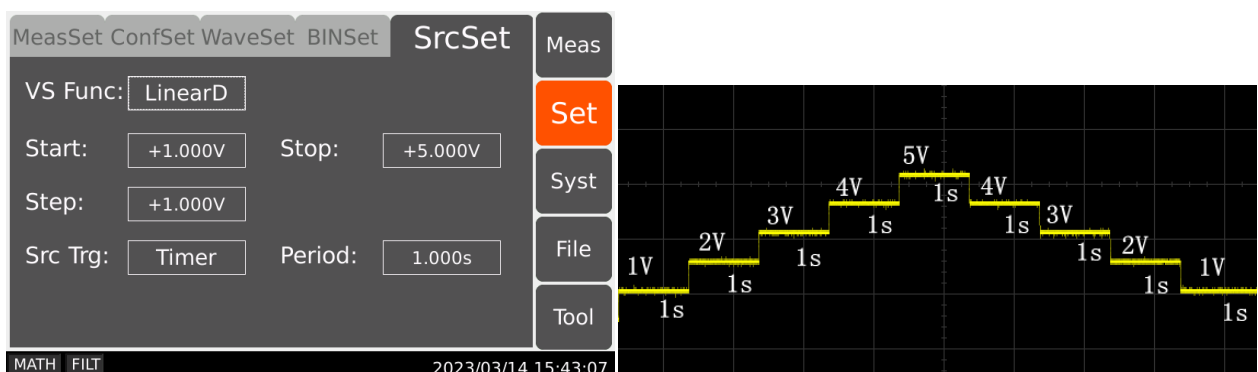

5.11.3 Square Waveform Output

Set and output waveform as shown in the following figure: can continuously output square waveform output.

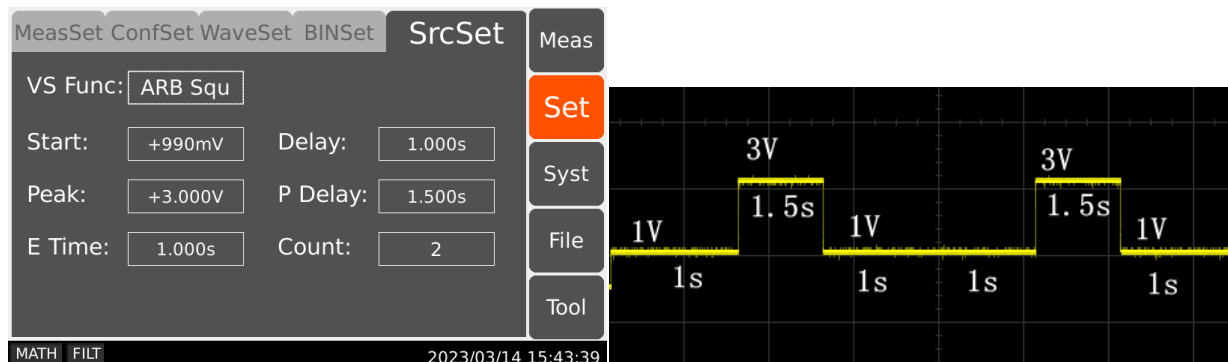

5.11.4 List Sweep Output

Set and output waveform as shown in the following figure: Set any voltage and period time.

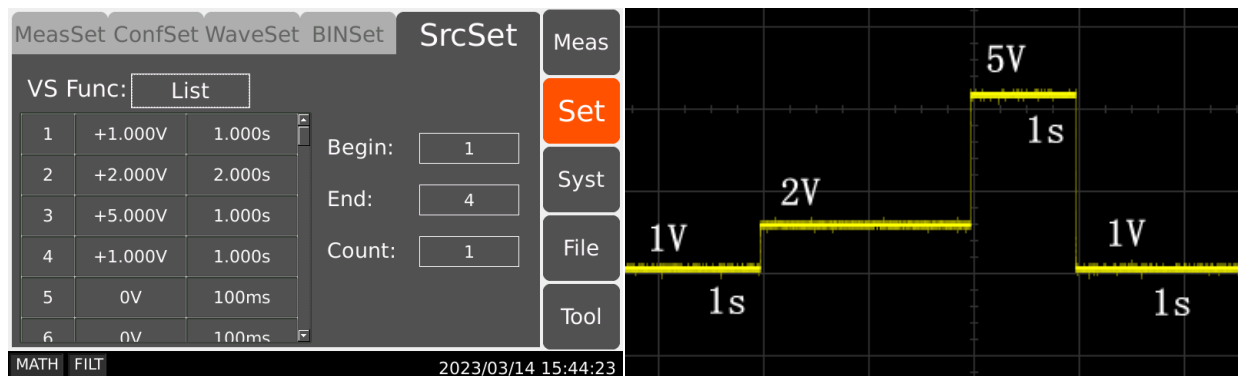

5.12 Offset Cancel and Zero Correction

5.12.1 Zero Correction

The instrument supports zero correction function, which can clear the deviation of the internal circuit of the instrument. Press the Zero key when electrometer or ammeter is selected to enable zero correction (range locked). The instrument will automatically measure and record all the deviation in current measurement range. The indicator display is shown in the following figure.



After Zero Correction is enabled, the instrument will automatically deduct deviation at the measurement range, ZC indicator turns white, showing Zero Correction is active. After changing the measurement range, ZC indicator turns gray showing it is inactive.

5.12.2 Null, Offset Cancel

This instrument has Null (offset cancel) function. The value measured on pressing the Zero key is stored as offset value, and the Zero indicator turns on as shown in the following figure. The displayed value is the value that subtracts the offset value from the actual measurement value. Press the Zero key again, the Null function is disabled, the indicator turns off.



Example: Measurement value is 0.2. Press Zero to enable Null function, the value 0.2 is stored as offset value. If the measurement value is 0.5 now, it displays 0.3 ($0.5 - 0.2$). Press the Zero key again to disable the Null function. If the measurement value is 0.5, it displays 0.5 now.

5.13 Measurement Considerations

5.13.1 Insulating Material

The need to use high-resistance insulation materials in connection parts, such as cables, adapters, and others, is essential to ensure the reliability of ultra-low current measurements. Poor insulation will allow greater leakage current.

5.13.2 Leakage Current on Connection Parts

Contaminants such as moisture or ionic chemicals can cause electrochemical effects that degrade insulation resistance. In some cases, ionic chemicals create a battery effect that sources offset current. This effect is not stable and will be a major obstacle to obtaining reliable low-current measurements. It is important to keep the surface of insulation material clean.

5.13.3 Humidity and Temperature

Water and water vapor can easily cause electrochemical effects. It is effective to maintain constant low humidity in the measurement environment in order to prevent the occurrence of an electrochemical effect. Temperature changes can create contaminating condensation that, in turn, can lead to a serious degradation in the insulation performance.

You must control the temperature and humidity in the measurement environment appropriately.

5.13.4 Offset

The ideal measurement instrument shows no current flow when nothing is connected to the measurement terminals and no voltage is being applied. However, in a real-world measurement environment, an instrument will have a certain amount of offset current. The offset current can be reduced by using the offset cancel function and so on.

5.13.5 Cable Noise

Cable noise can be caused in two ways: by the triboelectric effect and by the piezoelectric effect. The triboelectric effect is the result of friction caused by motion at the boundary between the conductor and the insulator. The piezoelectric effect is the result of mechanical stress applied to the insulator. Current from both of these effects can negatively influence low current measurements.

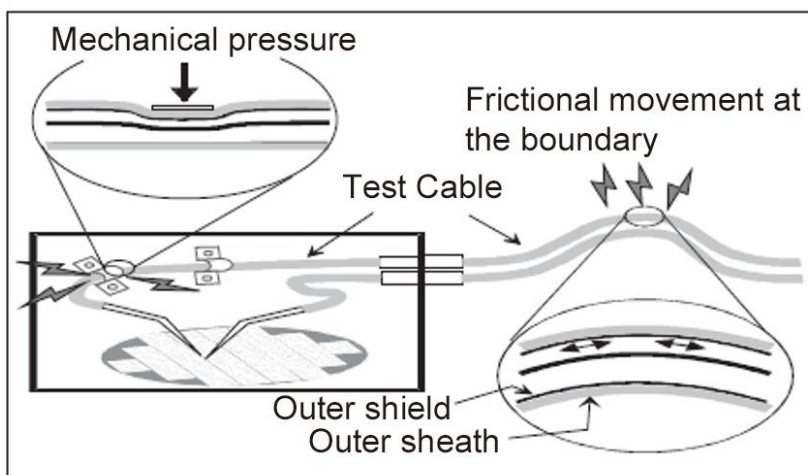

Generally, using the low noise coaxial cable can reduce the noise caused by vibration. Also fixing the cable is effective for preventing it from vibration. Note that applying too much stress to the cable or bending it tightly will have a detrimental effect on the measurements.

5.13.6 External Noise

Power line noise is one of the major sources that can negatively affect low current measurements. Usually, noise current comes from capacitor. Even if it has low capacitance,

it causes large noise. So, it is desirable to eradicate the capacitive coupling. Shielding can be a countermeasure for the external noise.

5.13.7 Dielectric Absorption

Change of electric field applied to an insulation material causes the leakage current which needs long convergence time. This is the phenomenon called as the dielectric absorption. The level of current and the length of convergence time depend on the type of insulation material and the amount of electric field change. This undesirable phenomenon can be alleviated by selecting the insulation material of low dielectric absorption and by using the guard technique effective for reducing the electric field change. Current compensation is difficult because the current level changes along with the passage of time. So it is important to wait enough time until the current converges.

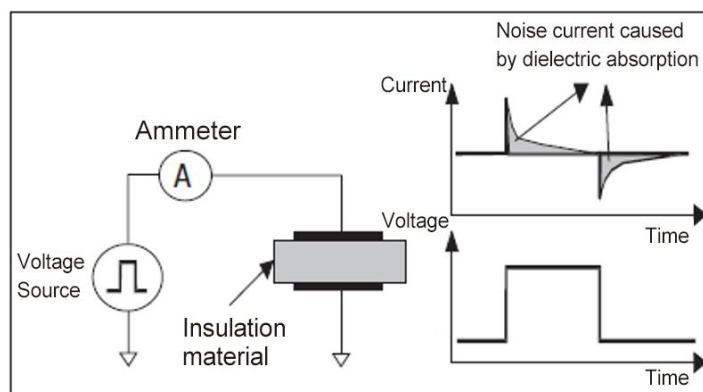

5.13.8 Capacitive Coupling

Capacitive coupling between the different potential will cause the noise current when the applied voltage is changed or when the capacitance is changed.

$$I = C \frac{dV}{dt} + V \frac{dC}{dt}$$

It is important to apply shielding for eliminating the capacitive couple with voltage fluctuation and to prevent vibration for blocking the change of the coupling capacitance.

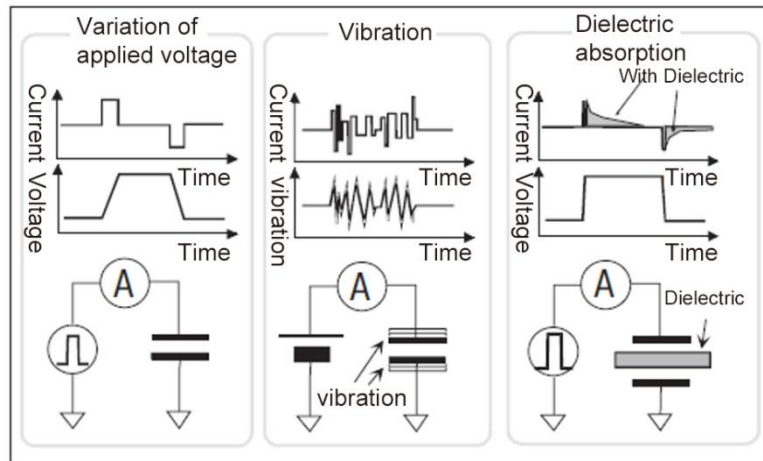

5.13.9 Light

In some devices such as diode and transistor, electron-hole pairs generated by light can create currents which negatively impact low current measurements. Current caused by light is unstable and slow to change. It is important to apply shielding for cutting off the light and to prevent reflection inside the shielding.

Chapter 6 Interfaces and Communication

This instrument supports RS232C serial port, GPIB, LAN, and USB interface for data communication and remote control without instrument panel. They use the same command, but different hardwares and protocols.

CAUTION: Electrostatic discharges greater than 1 kV near the interface connectors may cause the unit to reset and require operator intervention.

6.1 RS232

6.1.1 RS232 Interface Description

The RS232 interface provided by the instrument can be used to communicate with the computer, providing rich program control commands. Through the RS232 interface, the computer can implement almost all functions on the instrument panel, compatible with the SCPI instruction and MODBUS instruction of the instrument and can change the protocol in Syst-BusSys-Mode: Rs232.

6.1.2 RS232 Interface Introduction

The widely used serial communication standard now is RS-232 standard, also known as asynchronous serial communication standard, for the data communication between computers, and computers to peripherals. RS stands for “Recommended Standard”, 232 is the standard number defined by the Electronic Industries Association (EIA) in 1969. This standard allows data transmission one bit at a time over a data line.

The configuration of most serial ports is usually not strictly based on the RS-232 standard: 25-core connectors are used for each terminal (9-core connectors are used in IMB AT). The most commonly used RS-232 signals are shown in Table 6-1-1:

Signal	Abbreviation	25-core connector Pin#	9-core connector Pin#
Request to send	RTS	4	7
Clear to send	CTS	5	8
Data set ready	DSR	6	6
Data carrier detect	DCD	8	1
Data terminal ready	DTR	20	4
Transmitted data	TXD	2	3

Received data	RXD	3	2
Common ground	GND	7	5

Table
6-1-1

Like most serial interfaces in the world, the serial interface of this instrument is not strictly based on the RS-232 standard, but only provides a minimal subset like Table 6-1-2 shows:

Signal	Abbreviation	Connector Pin#
Transmitted data	TXD	3
Received data	RXD	2
Common ground	GND	5

Table 6-1-2

This is the simplest and cheapest way to communicate using serial ports.

NOTE: The serial port pin definition of this instrument is basically the same as the pin definition of the standard 9-core RS232C connector.

The RS232C connector of this instrument uses a 9-core pin type DB socket, and the pin sequence is shown in Figure 6-1-3 below:



Figure 6-1-3

Use standard DB type 9-core plug for connection

WARNING: To avoid electrical shock, turn off the power before inserting or removing the connector;

WARNING: Do not short the output terminal or the case to avoid damage to the device

6.1.3 Communicate with a computer

Connection between the instrument and the computer is shown in Figure 6-1-4:

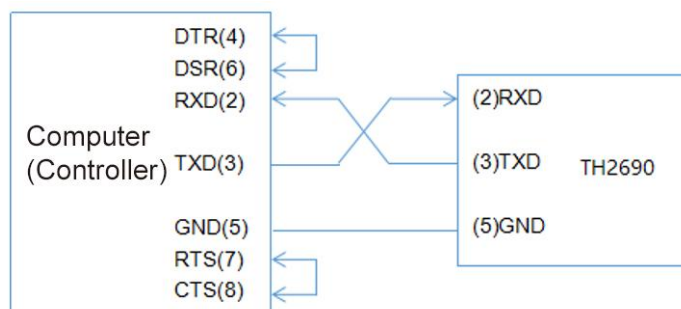

Figure 6-1-4

As the figure shows, the pin definition of this instrument is the same as the pin definition of the 9-core connector serial interface used in IMB AT compatibles. Users can make the three-wire connection cable (length < 1.5m) by using the two-core shielded wire according to the figure, or purchase the serial interface cable between the computer and the instrument from Tonghui, or purchase the standard DB9-core cable directly(cross wire).

When self-making cables, pay attention to short pin 4 with pin 6, and pin 7 with pin 8 on the computer connector.

Main parameters for serial port

Transmission Mode	Full duplex asynchronous communication with start and stop bits
Baud rate	-----bps
Data bit	8 BIT
Stop bit	1 BIT
Calibration	none
End character	NL (newline, ASCII code 10)
Communication	Software communication
Connector	DB9-core

6.2 LAN

6.2.1 LAN Remote System

LAN (Local area Network) remote control system controls devices through a LAN interface. It is compatible with SCPI instruction of this instrument.

6.2.2 System Configuration

Connect the LAN port on the rear panel of the TH2690 series to the network port of

the computer through an ethernet cable. Set the IP address and port number.

6.3 USBTMC

6.3.1 USBTMC remote control system

USB (universal serial Bus) remote control system through the USB interface to control the equipment, compatible with the instrument SCPI instruction.

6.3.2 System Configuration

Connect the USB port on the rear panel of TH2690 to the USB port on the host through the USB cable, and set the USB to TMC, see Syst-BusSys-Mode:USB.

6.4 USBCDC

6.4.1 USBCDC Virtual Serial Port

By selecting the bus type USBCDC, you can configure the USB port as a virtual serial port (VCom). Compatible with SCPI commands.

6.4.2 System Configuration

Connect the USB port on the rear panel of TH2690 to the USB port on the host via a USB cable, set the USB to CDC, see Syst-BusSys-Mode:USB.

6.5 GPIB

6.5.1 GPIB Remote Control System

Connect the GPIB card with the TH2690 interface to remotely control the instrument and be compatible with the SCPI commands of the instrument.

6.5.2 System Configuration

Connect to the TH2690 interface via the GPIB card. In Syst-BusSys, set the instrument address, namely GPIB address.

6.6 Communication Commands SCPI

SCPI instructions are tree-structured, where the highest level is called a subsystem command. The layers under a subsystem command are valid only if the subsystem

command is selected, using colons to separate the hierarchy of instructions. The command structure follows the following basic rules:

- (1) Ignore upper and lower cases
- (2) The space is used to separate the command from its parameter. Command is before the space, and parameter is after the space.
- (3) Space () cannot be put before or after a colon.
- (4) Command followed by a question mark (?) executes a query to it.
- (5) Two commands are separated by a semicolon.

6.6.1 Instruement Subsystem Commands

●DISP	●FUNC	●VOLT	●CURR
●RES	●CHAR	●SRC	●FILT
●MATH	●WAVE	●BIN	●VSFUNC
●SYS	●HAND	●FETCH	

6.6.2 Public Commands

Inquire instrument

- ◆ Description: Used to inquire insutruement model and version.

Syntax: *IDN?

Instruement Reset

- ◆ Description: Used to reset the instrument, and its parameters.

Syntax: *RST

Factory Reset

- ◆ Description: Used to factory reset parameters and system settings to the factory default.

Syntax: *FACT

6.6.3 DISP Command Set

- ◆ Description: Control Page Switching

Syntax: :DISP:PAGE?

:DISP:PAGE <PageName>

Parameters: See the definitions and descriptions of the PageName in the following table.

PageName	Definition	Inquiry Return
MEAS	Measurement display interface	MEAS
SETM	Measurement settings interface	SETM
SETC	Measurement configurations interface	SETC
SETW	Waveform settings interface	SETW
BIN	BIN settings interface	BIN
VSF	Voltage source settings interface	VSF
SYSE	System environment interface	SYSE
SYSB	BUS interface	SYSB
SYSS	System settings interface	SYSS
SYSH	HANDLER settings interface	SYSH
FILE	File interface	FILE
TOOL	Tool interface	TOOL

Example: :DISP:PAGE MEAS ----Enter the measurement display; page
 :DISP:PAGE SETM ----Enter the measurement settings page;
 :DISP:PAGE? ----Back to the current page, see the table
 above.

6.6.4 FUNC Command Set

Function Selection

- ◆ Description: Used to choose the measurement function of the instrument.

Syntax: FUNC?

FUNC <RES | VOLT | CURR | COUL | SRC>

Parameters: RES ---- Access the resistance meter

VOLT ---- Access the voltmeter

CURR ---- Access the ammeter

COUL ---- Access the electrometer

SRC ---- Access the voltage source settings

Example: FUNC:FUNC CURR ---- Access the ammeter

FUNC:FUNC? ---- Back to the current function.

Voltage Source Switch

◆ Description: Used to control the voltage source switch

Syntax: SRC?

SRC < ON | OFF >

Parameter: ON ---- Turn the voltage source switch On

OFF ---- Turn the voltage source switch Off

Example: FUNC:SRC OFF ---- Turn off the voltage source

FUNC:SRC? ---- Back to the current voltage source state.

Ammeter Switch

◆ Description: Used to control the ammeter switch

Syntax: AMMET?

AMMET < ON | OFF >

Parameter: ON ---- Turn on the ammeter

OFF ---- Turn off the ammeter

Example: FUNC: AMMET OFF ---- Turn off the ammeter

FUNC: AMMET? ---- Back tot the current ammeter

state.

Null/ Zero Switch

- ◆ Description: Used to control the switch for the Null function.

Syntax: ZERO?

ZERO < ON | OFF >

Parameter: ON ---- Turn on Null

OFF ---- Turn off Null

Example: FUNC:ZERO OFF ----Turn off Null

FUNC:ZERO? ----Back to the current Null State

Run Measurement

- ◆ Description: Used to start the measurement

Example: FUNC:RUN ----start the measurement

Stop Measurement

- ◆ Description: Used to stop the measurement

Example: FUNC:STOP ----stop the measurement

6.6.5 VOLT Voltmeter Command Set

Voltmeter Measurement Range

- ◆ Description: Used to control the voltmeter measurement range.

Syntax: RANGE?

RANGE < 1 | 2 | 3 >

Parameter: 1 ---- Auto

2 ---- 2V

3 ---- 20V

Example: VOLT:RANGE 1 ----Set the voltmeter measurement range

to auto

VOLT:RANGE? ----Back to the current voltmeter measurement

range.

Voltmeter Measurement Speed

- ◆ Description: Used to control the voltmeter measurement speed.

Syntax: SPEED?

SPEED < FAST | MID | SLOW >

Parameter: FAST ---- high speed

MID ---- mid speed

SLOW ---- low speed

Example: VOLT:SPEED MID ----Set the voltmeter measurement speed to mid speed.

VOLT:SPEED? ----Back to the current voltmeter measurement speed.

Voltmeter Sorting Switch

- ◆ Description: Used to control the voltmeter measurement sorting switch

Syntax: SORT?

SORT < ON | OFF >

Parameter: ON ---- turn it on

OFF ---- turn it off

Example: VOLT:SORT OFF ----Turn the voltmeter sorting off

VOLT:SORT? ----Back to the current voltmeter sorting state.

Voltmeter Sorting Upper Limit

- ◆ Description: Used to set the upper limit for voltmeter measurement sorting.

Syntax: UPPER?

UPPER < float >

Parameter: float ---- float data type

Example: VOLT:UPPER 0.0126 ----Set the upper limit to 0.0126A

VOLT:UPPER? ----Back to the current voltmeter
sorting upper limit.

Voltmeter Sorting Lower Limit

◆ Description: Used to set the lower limit for voltmeter measurement sorting.

Syntax: LOWER?

LOWER < float >

Parameter: float ---- Float data type

Example: VOLT:LOWER 0.0026 ----Set the lower limit to 0.0026A

VOLT:LOWER? ----Back to the current voltmeter
sorting lower limit.

Voltmeter Guarded Mode

◆ Description: Used to control the guarded mode for voltmeter measurement.

Syntax: PROT?

PROT < GUARD | CCOM >

Parameter: GUARD ---- GUARD Mode

CCOM ---- CCOM Mode

Example: VOLT:PROT CCOM ----Set the Guarded Mode to be
CCOM

VOLT:PROT? ----Back to the current voltmeter guarded
mode.

6.6.6 CURR Ammeter Command Set

Ammeter Measurement Range

- ◆ Description: Used to control the ammeter measurement range

Syntax: RANGE?

RANGE < 1 | 2 | 3 | 4 | 5 | 6 | 7 | 8 | 9 | 10 | 11 >

Parameter: 1 ---- Auto

2 ---- 20mA

3 ---- 2mA

4 ---- 200uA

5 ---- 20uA

6 ---- 2uA

7 ---- 200nA

8 ---- 20nA

9 ---- 2nA

10 ---- 200pA

11 ---- 20pA

Example: CURR:RANGE 2 ----Set the ammeter measurement range to
be 20mA

CURR:RANGE? ----Back to the current ammeter
measurement range.

Ammeter Measurement Speed

- ◆ Description: Used to control the ammeter measurement speed.

Syntax: SPEED?

SPEED < FAST | MID | SLOW >

Parameter: FAST ---- high speed

MID ---- mid speed

SLOW ---- low speed

Example: CURR:SPEED MID ----Set the ammeter
measurement speed to mid speed.

CURR:SPEED? ----Back to the current ammeter
measurement speed.

Ammeter Sorting Switch

- ◆ Description: Used to control the ammeter measurement sorting switch

Syntax: SORT?

SORT < ON | OFF >

Parameter: ON ---- Turn it on

OFF ---- Turn it off

Example: CURR:SORT OFF ----Turn off the ammeter sorting

CURR:SORT? ----Back to the current ammeter sorting
state.

Ammeter Sorting Upper Limit

- ◆ Description: Used to set the ammeter measurement sorting upper limit.

Syntax: UPPER?

UPPER < float >

Parameter: float ---- Float data type

Example: CURR:UPPER 0.0126 ----Set the upper limit to 0.0126A

CURR:UPPER? ----Back to the current sorting upper
limit.

Ammeter Sorting Lower Limit

- ◆ Description: Used to set the ammeter measurement sorting lower limit.

Syntax: LOWER?

LOWER < float >

Parameter: float ---- Float data type

Example: CURR:LOWER 0.0026 ----Set the lower limit to 0.0026A

CURR:LOWER? ----Back to the current sorting lower
limit

6.6.7 RES Resistance Meter Command Set

Resistance Meter Measurement Range

- ◆ Description: Used to control the measurement range of the resistance meter.

Syntax: RANGE?

RANGE < 1 | 2 | 3 | 4 | 5 | 6 | 7 | 8 | 9 | 10 | 11 >

Parameter: 1 ---- Auto

2 ---- 100TΩ

3 ---- 10TΩ

4 ---- 1TGΩ

5 ---- 100GΩ

6 ---- 10GΩ

7 ---- 1GΩ

8 ---- 100MΩ

9 ---- 10MΩ

10 ---- 1MΩ

11 ---- Manuel

Example: RES:RANGE 11 ----Set the resistance meter measurement range to manuel.

RES:RANGE? ----Back to the current resistance meter measurement range.

Resistance Meter Measurement Speed

◆ Description: Used to control the measurement speed of the resistance meter.

Syntax: SPEED?

SPEED < FAST | MID | SLOW >

Parameter: FAST ---- high speed

MID ---- mid speed

SLOW ---- low speed

Example: RES:SPEED MID ----Set the resistance meter measurement speed to mid speed.

RES:SPEED? ----Back to the current measurement speed.

Resistance Meter Sorting Switch

◆ Description: Used to control the resistance meter measurement sorting switch.

Syntax: SORT?

SORT < ON | OFF >

Parameter: ON ---- Turn it on

OFF ---- Turn it off

Example: RES:SORT OFF ----Turn off the resistance meter sorting

RES:SORT? ----Back to the current sorting state

Resistance Meter Sorting Upper Limit

◆ Description: Used to set the resistance meter measurement sorting upper limit.

Syntax: UPPER?

UPPER < float >

Parameter: float ---- Float data type

Example: RES:UPPER 1e7 ----Set the resistance meter upper limit to 10MΩ

RES:UPPER? ----Back to the current upper limit.

Resistance Meter Sorting Lower Limit

- ◆ Description: Used to set the resistance meter sorting lower limit

Syntax: LOWER?

LOWER < float >

Parameter: float ---- Float data type

Example: RES:LOWER 1000 ----Set the resistance meter lower limit to 1kΩ

RES:LOWER? ----Back to the current resistance sorting lower limit

Resistance Calculation Mode

- ◆ Description: Used to select the voltage source for calculating resistance

Syntax: COMP?

COMP < VM | VS >

Parameter: VM ---- voltage of the DUT measured by voltmeter

VS ---- output source voltage of the instrument

Example: RES: COMP VS ----Set the resistance calculation mode to internal voltage source

RES: COMP? ----Back to the current resistance calculation mode

6.6.8 CHAR Electrometer Command Set

Electrometer Measurement Range

- ◆ Description: Used to control the measurement range of the electrometer

Syntax: RANGE?

RANGE < 1 | 2 | 3 | 4 | 5 | 6 >

Parameter: 1 ---- 2~20nC

2 ---- 200~2000nC

3 ---- 2nC

4 ---- 20nC

5 ---- 200nC

6 ---- 2000nC

Example: CHAR:RANGE 2 ----Set the electrometer measurement range to 200~2000nC.

CHAR:RANGE? ----Back to the current electrometer measurement range.

Electrometer Measurement Speed

- ◆ Description: Used to control the measurement speed of the electrometer

Syntax: SPEED?

SPEED < FAST | MID | SLOW >

Parameter: FAST ---- high speed

MID ---- mid speed

SLOW ---- low speed

Example: CHAR:SPEED MID ----Set the measurement speed of the electrometer to mid speed

CHAR:SPEED? ----Back to the current measurement speed

Electrometer Sorting Switch

- ◆ Description: Used to control the electrometer sorting switch

Syntax: SORT?

SORT < ON | OFF >

Parameter: ON ---- Turn it on

OFF ---- Turn it off

Example: CHAR:SORT OFF ----Turn off the electrometer sorting

CHAR:SORT? ----Back to the current electrometer
sorting state

Electrometer Sorting Upper Limit

- ◆ Description: Used to set the electrometer sorting upper limit

Syntax: UPPER?

UPPER < float >

Parameter: float ---- Float data type

Example: CHAR:UPPER 1e-7 ----Set the resistance upper limit
to 100nC

CHAR:UPPER? ----Back to the current
resistance sorting upper limit

Electrometer Sorting Lower Limit

- ◆ Description: Used to set the electrometer sorting lower limit

Syntax: LOWER?

LOWER < float >

Parameter: float ---- Float data type

Example: CHAR:LOWER 1e-8 ----Set the resistance lower limit to

10nC

CHAR:LOWER? ----Back to the current resistance
 sorting lower limit

Auto Discharge

◆ Description: Used to set the auto discharge switch

Syntax: DISC?

DISC < ON | OFF >

Parameter: ON ---- Turn it on

OFF ---- Turn it off

Example: CHAR: DISC ON ----Turn auto discharge on

CHAR: DISC? ----Back to the current auto discharge
 mode

Discharge Level

◆ Description: Used to choose the discharge level

Syntax: LEVEL?

LEVEL < 1 | 2 | 3 | 4 >

Parameter: 1 ---- 2nC

2 ---- 20nC

3 ---- 200nC

4 ---- 2000nC

Example: CHAR: LEVEL 2 ----Set the discharge level to 20nC

CHAR: LEVEL? ----Back to the current discharge level

6.6.9 SRC Voltage Source Command Set

Voltage Source Measurement Range

- ◆ Description: Used to control the voltage source measurement range

Syntax: RANGE?

RANGE < 1 | 2 | 3 >

Parameter: 1 ---- -20~20V
 2 ---- 0~1000V
 3 ---- -1000~0V

Example: SRC:RANGE 2 ----Set the voltage source measurement range to 0~1000V

SRC:RANGE? ----Back to the current electrometer measurement range

Voltage Source Output Value

- ◆ Description: Used to set the voltage source output value

Syntax: VALUE?

VALUE < float >

Parameter: float ---- Float data type

Example: SRC:VALUE 1.23 ----Set the voltage source output to 1.23V

SRC: VALUE ? ----Back to the current voltage source value

Output Off State

- ◆ Description: Used to choose the voltage source off state

Syntax: OFFS?

OFFS < HIGHZ | NORMAL | ZERO >

Parameter: HIGHZ ---- high resistance

NORMAL ---- normal

ZERO ---- zero

Example: SRC: OFFS NORMAL ----Set the voltage source off state to normal

SRC: OFFS? ----Back to the current off state

Power Supply Grounding Mode

◆ Description: Used to choose the grounding mode for power supply

Syntax: GND?

GND < CCOM | FLOAT >

Parameter: CCOM ---- common ground

FLOAT ---- floating

Example: SRC: GND FLOAT ----Set the grounding mode to floating

SRC: GND? ----Back to the current grounding mode

Power Supply Current Limiting Resistance

◆ Description: Used to choose the power supply current limiting resistance

Syntax: RES?

RES < HIGH | ZERO >

Parameter: HIGH ---- 20M

ZERO ---- 0

Example: SRC: RES HIGH ----Set the power supply current limit resistance to 20M

SRC: RES? ----Back to the current power supply current limit resistance

VS Waveform Output Trigger

◆ Description: Used to trigger the output of a voltage source when selecting a

non-DC output (single step wave, square wave, etc.)

Syntax: TRIG

Example: SRC: TRIG ----Trigger VS waveform output

6.6.10 FILT Filter Command Set

Filter Mode

◆ Description: Used to control the measurement range of the voltage source

Syntax: MODE?

MODE < OFF | AVER | MED | SLIDE >

Parameter: OFF ---- filter off

AVER ---- average filter

MED ---- median filter

SLIDE ---- slide filter

Example: FILT:MODE SLIDE ----Set the filter to slide filter

FILT:MODE? ----Back to the current filter mode

Filter Sample Number

◆ Description: Used to set the voltage source output value

Syntax: NUMB?

NUMB < int >

Parameter: int ---- Integer data type

Example: FILT:NUMB 3 ----Set the current filter sample number to 3

FILT:NUMB? ----Back to the current sample number

6.6.11 MATH Mathematical Command Set

Mathematical Function Select

- ◆ Description: Used to choose the mathematical function

Syntax: ITEMS?

ITEMS < NONE | MXPL | MREC | RATI | PERC | DEVI | PERD |
LOG | POLI |SRES|VRES>

Parameter: NONE ---- close

MXPL ---- Scaling migration

MREC ---- Reciprocal scaling migration

RATI ---- Ratio

PERC ---- Percentage ratio

DEVI ---- Deviation

PERD ---- Percentage deviation

LOG ---- Logarithm

POLI ---- Polynomial

SRES ---- Surface resistivity

VRES ---- Volume resistivity

Example: MATH:ITEMS NONE ----Close mathematical function

MATH:ITEMS? ----Back to the current mathematical
function.

Function Coefficient 1

- ◆ Description: Used to set coefficient 1 for the current mathematical function

Syntax: FACT1?

FACT1< float >

Parameter: float ---- Float data type

Example: MATH:FACT1 1.23 ---- Set the current coefficient 1 to 1.23

MATH:FACT1? ---- Back to the current coefficient 1

Function Coefficient 2

- ◆ Description: Used to set coefficient 2 for the current mathematical function coefficient 2

Syntax: FACT2?

FACT2< float >

Parameter: float ---- Float data type

Example: MATH:FACT2 1.23 ----Set the current coefficient 2 to 1.23

MATH:FACT2? ----Back to the current coefficient 2

Function Coefficient 3

- ◆ Description: Used to set the current mathematical function coefficient 3

Syntax: FACT3?

FACT3< float >

Parameter: float ---- Float data type

Example: MATH:FACT3 1.23 ----Set the current coefficient 3 to 1.23

MATH:FACT3? ----Back to the current coefficient 3

6.6.12 WAVE Waveform Settings Command Set

Waveform Display

- ◆ Description: Used to set whether to display waveform

Syntax: DISP?

DISP < ON | OFF >

Parameter: ON ---- on

OFF ---- off

Example: WAVE: DISP ON ----Turn on the waveform display

WAVE: DISP? ----Back to the current waveform display

Waveform Type

- ◆ Description: Used to set the waveform type

Syntax: TYPE?

TYPE < GRAPH | HIST >

Parameter: GRAPH ---- line graph

HIST ---- Histogram

Example: WAVE: TYPE GRAPH ----Set the waveform to line graph

WAVE: TYPE? ----Back to the current waveform

type

Line Graph X-axis Parameter

- ◆ Description: Used to set the parameter of the line graph x-axis

Syntax: GRAPH:XPARA?

GRAPH:XPARA < CURR | COUL | VOLT | RES | MATH | TIME
| SRC >

Parameter: CURR ---- current value

COUL ---- coulomb value

VOLT ---- voltage value

RES ---- resistance value

MATH ---- math value

TIME ---- time value

SRC---- voltage source value

Example: WAVE: GRAPH:XPARA TIME ---- Set the x-axis parameter to
time

WAVE: GRAPH:XPARA? ---- Back to the current x-axis
parameter

Line Graph X-axis Maximun

◆ Description: Used to set the maximun of the x-axis parameter

Syntax: GRAPH:XMAX?

GRAPH:XMAX < float >

Parameter: float ---- Float data type

Example: WAVE: GRAPH:XMAX 1.23 ---- Set the x-axis maximum to
1.23

WAVE: GRAPH:XMAX? ---- Back to the current x-axis
maximum

Line Graph X-axis Minimun

◆ Description: Used to set the minimum of the x-axis parameter

Syntax: GRAPH:XMIN?

GRAPH:XMIN < float >

Parameter: float ---- Float data type

Example: WAVE: GRAPH:XMIN 0.002 ---- Set the x-axis minimum to
0.002

WAVE: GRAPH:XMIN? ---- Back to the current x-axis
minimum

Line Graph Y-axis Parameter

◆ Description: Used to set the parameter of the line graph y-axis

Syntax : GRAPH:YPARA?

 GRAPH:YPARA < CURR | COUL | VOLT | RES | MATH >

Parameter: CURR ---- current value

COUL ---- coulomb value

VOLT ---- voltage value

RES ---- resistance value

MATH ---- math value

 Example: WAVE: GRAPH:YPARA CURR ---- Set the y-axis
parameter to current

 WAVE: GRAPH:YPARA? ---- Back to the current y-
axis parameter

Line Graph Y-axis Maximum

◆ Description: Used to set the maximum of the y-axis parameter

Syntax: GRAPH:YMAX?

GRAPH:YMAX < float >

Parameter: float ---- Float data type

 Example: WAVE: GRAPH:YMAX 1.23 ---- Set the y-axis maximum to
1.23

 WAVE: GRAPH:YMAX? ---- Back to the current y-axis
maximum

Line Graph Y-axis Minimum

◆ Description: Used to set the minimum of the y-axis parameter

Syntax: GRAPH:YMIN?

GRAPH:YMIN < float >

Parameter: float ---- Float data type

Example: WAVE: GRAPH:YMIN 0.002 ---- Set the y-axis minimum to

0.002

WAVE: GRAPH:YMIN? ---- Back to the current y-axis
minimum

Line Graph Auto Ratio

- ◆ Description: Used to set whether to enable auto ratio or not

Syntax: GRAPH:AUTOR?

GRAPH:AUTOR < ON | OFF >

Parameter: ON ---- on

OFF ---- off

Example: WAVE: GRAPH:AUTOR ON ---- Turn on auto ratio

WAVE: GRAPH:AUTOR? ---- Back to the current auto
ratio state

Histogram X-axis Parameter

- ◆ Description: Used to set the histogram x-axis parameter

Syntax: HIST:XPARA?

HIST:XPARA < CURR | COUL | VOLT | RES | MATH >

Parameter: CURR ---- current value

COUL ---- coulomb value

VOLT ---- voltage value

RES ---- resistance value

MATH ---- math value

Example: WAVE: HIST:XPARA CURR ---- Set the x-axis parameter to
current

WAVE: HIST:XPARA? ---- Back to the current x-axis
parameter

6.6.13 BIN Limit Settings Command Set

Limit Test

- ◆ Description: Used to set whether to enable limit test or not.

Syntax: LTEST?

LTEST < ON | OFF >

Parameter: ON ---- on

OFF ---- off

Example: BIN: LTEST ON ----Turn on limit test

BIN: LTEST? ----Back to the current limit test state

Limit Mode

- ◆ Description: Used to set the limit test mode

Syntax: LMODE?

LMODE < GRADING | SORTING >

Parameter: GRADING

SORTING

Example: BIN: LMODE GRADING ----Set the limit mode to GRADING

BIN: LMODE? ----Back to the current limit mode

Feed Data Type

- ◆ Description: Used to set the limit test feed data type

Syntax: FDATA?

FDATA < CURR | COUL | VOLT | RES >

Parameter: CURR ---- current value

COUL ---- coulomb value

VOLT ---- voltage value

RES ---- resistance value

Example: BIN: FDATA CURR ----Set the limit test feed data to current

BIN: FDATA? ----Back to the current limit test feed data

BIN Index

◆ Description: Used to set the BIN index

Syntax: INDEX?

INDEX < 1 | 2 | 3 | 4 | 5 | 6 | 7 >

Parameter: 1 ---- index 1

2 ---- index 2

3 ---- index 3

4 ---- index 4

5 ---- index 5

6 ---- index 6

7 ---- index 7

Example: BIN: INDEX 1 ----Set the limit test index to 1

BIN: INDEX? ----Back to the current limit test index.

BIN Switch

◆ Description: Used to set the BIN switch

Syntax: BTEST?

BTEST < 1 | 2 | 3 | 4 | 5 | 6 | 7 > < ON | OFF >

Parameter: 1 ---- index 1

2 ---- index 2

3 ---- index 3

4 ---- index 4

5 ---- index 5

6 ---- index 6

7 ---- index 7

ON ---- on

OFF ---- off

Example: BIN: BTEST 1,ON ---- turn on BIN 1

BIN: BTEST? ----Back to the current BIN switch mode

Fail On

◆ Description: Set the Fail judgement range

Syntax: FAILON?

FAILON < 1 | 2 | 3 | 4 | 5 | 6 | 7 > <IN | OUT >

Parameter: 1 ---- index 1

2 ---- index 2

3 ---- index 3

4 ---- index 4

5 ---- index 5

6 ---- index 6

7 ---- index 7

IN ---- inside range

OUT ---- outside range

Example : BIN: FAILON 1,IN ----Set the fail condition as inside range
for BIN 1

BIN: FAILON? ----Back to the current fail on range

Pass Pattern

- ◆ Description: Used to set the pass pattern output

Syntax: PASSPT?

PASSPT < n > < m >

Parameter: n ---- index number (1~7)

m ---- output (1~14)

Example: BIN: PASSPT 1,2 ----Set the pass pattern output for index 1
to 2 (0010)

BIN: PASSPT? ----Back to the current index pass pattern

Fail Pattern

- ◆ Description: Used to set the fail pattern output

Syntax: FAILPT?

FAILPT < n > < m >

Parameter: n ---- index number (1~7)

m ---- output (1~14)

Example: BIN: FAILPT 1,4 ----Set the fail pattern output for index 1
to 4 (0100)

BIN: FAILPT? ----Back to the current index fail pattern

Sorting Upper Limit

- ◆ Description: Used to set the sorting upper limit

Syntax: UPPER?

UPPER < n > < float >

Parameter: n ---- index number (1~7)

float ---- Float data type

Example: BIN: UPPER 1,1.2 ----Set the upper limit of BIN 1 to 1.2

BIN: UPPER? ----Back to the current sorting upper limit

Sorting Lower Limit

◆ Description: Used to set the sorting lower limit

Syntax: LOWER?

LOWER < n > <float >

Parameter: n ---- index number (1~7)

float ---- Float data type

Example: BIN: LOWER 1,0.1 ----Set the lower limit of BIN 1 to 0.1

BIN: LOWER? ----Back to the current sorting lower limit

BIN Settings

◆ Description: Used to configure all settings for one BIN

Syntax: SETBIN < n > < m > < a > < b > < c > < d > < e >

Parameter: n ---- index number (1~7)

m ---- BIN switch (ON | OFF)

a ---- fail on (IN | OUT)

b ---- pass pattern (1~14)

c ---- fail pattern (1~14)

d ---- sorting upper limit float

e ---- sorting lower limit float

Example: BIN:SETBIN 1,OFF,OUT,4,8,0.1,-0.1 ----Set the BIN 1 switch to off, fail outside the range, pass pattern to 4 (0100), fail pattern to 8 (1000), upper limit to 0.1, lower limit to -0.1

BIN Settings Inquiry

- ◆ Description: Used to inquire all settings of one BIN

Syntax: ASKBIN < n >

Parameter: n ---- index number (1~7)

Example: BIN:ASKBIN 1 ---- inquire settings for BIN 1

6.6.14 VSFUNC Waveform Output Command Set

Waveform Output

- ◆ Description: Used to set waveform output 用于设定波形输出

Syntax: MODE?

MODE < OFF | LINEARS | LINEARD | ARBSQU | LIST >

Parameter: OFF ---- off

LINEARS ---- single staircase sweep

LINEARD ---- double staircase sweep

ARBSQU ---- square wave output

LIST ---- list sweep

Example: VSFUNC:MODE OFF ----Turn off waveform output

VSFUNC:MODE? ----Back to the current waveform

output state

Single Staircase Sweep Starting Voltage

- ◆ Description: Used to set the single staircase sweep starting voltage

Syntax: SSTART?

SSTART < float >

Parameter: float ---- Float data type

Example: VSFUNC:SSTART 1.2 ----Set the single staircase sweep starting

voltage to 1.2V

VSFUNC:SSTART? ----Back to the starting voltage

Single Staircase Sweep Stopping Voltage

◆ Description: Used to set the single staircase sweep stopping voltage

Syntax: SSTOP?

SSTOP < float >

Parameter: float ---- Float data type

Example: VSFUNC:SSTOP 5.2 ---- Set the single staircase sweep
stopping voltage to 5.2V

VSFUNC:SSTOP? ----Back to the stopping voltage

Single Staircase Sweep Stepping Voltage

◆ Description: Used to set the single staircase sweep stepping voltage

Syntax: SSTEP?

SSTEP < float >

Parameter: float ---- Float data type

Example: VSFUNC:SSTEP 0.2 ---- Set the single staircase sweep
stepping voltage to 0.2V

VSFUNC:SSTEP? ----Back to the stepping voltage

Single Staircase Sweep Trigger Mode

◆ Description: Used to set the single staircase sweep trigger mode

Syntax: STRIG?

STRIG < TRIG | TIMER >

Parameter: TRIG ---- trigger

TIMER ---- timer

Example: VSFUNC:STRIG TIMER ---- Set the single staircase sweep trigger mode to timer

VSFUNC:STRIG? ----Back to the trigger mode

Single Staircase Sweep Timer

◆ Description: Used to set the single staircase sweep timer

Syntax: STIMER?

STIMER < float >

Parameter: float ---- Float data type

Example: VSFUNC:STIMER 0.2 ----Set the single staircase sweep timer to 0.2s

VSFUNC:STIMER? ----Back to the timer

Double Staircase Sweep Starting Voltage

◆ Description: Used to set the double staircase sweep starting voltage

Syntax: DSTART?

DSTART < float >

Float: float ---- Float data type

Example: VSFUNC:DSTART 1.2 ----Set the double staircase sweep starting voltage to 1.2V

VSFUNC:DSTART? ----Back to the starting voltage

Double Staircase Sweep Stopping Voltage

◆ Description: Used to set the double staircase stopping voltage

Syntax: DSTOP?

DSTOP < float >

Parameter: float ---- Float data type

Example: VSFUNC:DSTOP 5.2 ----Set the double staircase sweep

stopping voltage to 5.2V

VSFUNC:DSTOP? ----Back to the stopping voltage

Double Staircase Sweep Stepping Voltage

- ◆ Description: Used to set the double staircase sweep stepping voltage

Syntax: DSTEP?

DSTEP < float >

Parameter: float ---- Float data type

Example: VSFUNC:DSTEP 0.2 ----Set the double staircase sweep
stepping voltage to 0.2V

VSFUNC:DSTEP? ----Back to the stepping voltage

Double Staircase Sweep Trigger Mode

- ◆ Description: Used to set the double staircase sweep trigger mode

Syntax: DTRIG?

DTRIG < TRIG | TIMER >

Parameter: TRIG ---- trigger

TIMER ---- timer

Example: VSFUNC:DTRIG TIMER ----Set the double staircase sweep
trigger mode to timer

VSFUNC:DTRIG? ----Back to the trigger mode

Double Staircase Sweep Timer

- ◆ Description: Used to set the double staircase sweep timer

Syntax: DTIMER?

DTIMER < float >

Parameter: float ---- Float data type

Example: VSFUNC:DTIMER 0.2 ----Set the double staircase sweep timer to 0.2s

VSFUNC:DTIMER? ----Back to the timer

Square Wave Starting voltage

◆ Description: Used to set the square wave starting voltage

Syntax: ASTART?

ASTART < float >

Parameter: float ---- Float data type

Example: VSFUNC:ASTART 0.2 ---- Set the square wave starting voltage to 0.2V

VSFUNC:ASTART? ----Back to the starting voltage

Square Wave Starting Delay

◆ Description: Used to set the square wave starting delay

Syntax: ADELAY?

ADELAY < float >

Parameter: float ---- float data type

Example: VSFUNC:ADELAY 1.2 ---- Set the square wave starting delay to 1.2s

VSFUNC:ADELAY? ----Back to the starting delay

Sqaure Wave Peak Voltage

◆ Description: Used to set the square wave peak voltage

Syntax: APEAK?

APEAK < float >

Parameter: float ---- Float data type

Example: VSFUNC:APEAK 2.1 ---- Set the square wave peak voltage

to 2.1V

VSFUNC:APEAK? ----Back to the peak voltage

Square Wave Peak Delay

- ◆ Description: Used to set the square wave peak delay

Syntax: APDELAY?

APDELAY < float >

Parameter: float ---- Float data type

Example: VSFUNC:APDELAY 0.5 ---- Set the square wave peak delay
to 0.5s

VSFUNC:APDELAY? ----Back to the peak delay

Square Wave Stop Delay

- ◆ Description: Used to set the square wave stop delay

Syntax: AEDELAY?

AEDELAY < float >

Parameter: float ---- Float data type

Example: VSFUNC:AEDELAY 0.5 ----Set the square wave stop delay to
0.5s

VSFUNC:AEDELAY? ----Back to the stop delay

Square Wave Loop Count

- ◆ Description: Used to set the square wave loop count

Syntax: ACOUNT?

ACOUNT < int >

Parameter: int ---- Integer data type

Example: VSFUNC:ACOUNT 5 ----Set the square wave loop count to
5 times

VSFUNC:ACOUNT? ----Back to the loop count

List Sweep Start Number

- ◆ Description: Used to set the list sweep start number

Syntax: LSTART?

LSTART < int >

Parameter: int ---- Integer data type (1~100)

Example: VSFUNC:LSTART 5 ----Set the list sweep start number to
5

VSFUNC:LSTART? ----Back to the start number

List Sweep End Number

- ◆ Description: Used to set the list sweep end numebr

Syntax: LEND?

LEND < int >

Parameter: int ---- Integer data type (1~100)

Example: VSFUNC:LEND 50 ----Set the list sweep end number to
50

VSFUNC:LEND? ----Back to the end number

List Sweep Loop Count

- ◆ Description: Used to set the list sweep loop count

Syntax: LCOUNT?

LCOUNT < int >

Parameter: int ---- Integer data type

Example: VSFUNC:LCOUNT 10 ---- Set the list sweep loop count to 10
times

VSFUNC:LCOUNT? ----Back to the loop count

List Sweep Settings

- ◆ Description: Used to set the voltage and time for one step

Syntax: LSET < int >< m >< n >

Parameter: int ---- List step number (integer 1~100)

m ---- voltage (float data type)

n ---- time (float data type)

Example: VSFUNC: LSET 10,1.2,2.2 ----Set 1.2V and 2.2s for list step number 10.

List Sweep Setting Inquiry

- ◆ Description: Used to inquire the voltage and time for one step

Syntax: LASK < int >

Parameter: int ---- list step number (integer 1~100)

Example: VSFUNC: LASK 10 ---- Back to the voltage and time for list step number 10

6.6.15 SYS System Command Set

Language

- ◆ Description: Used to set the system language

Syntax: ENVI:LANG?

ENVI:LANG < CHN | ENG >

Parameter: CHN ---- Simplified Chinese

ENG ---- English

Example: SYS: ENVI:LANG CHN ----Set the system language to simplified Chinese

SYS: ENVI:LANG? ----Back to the system language

Beeper Switch

- ◆ Description: Used to set the system beeper switch

Syntax: ENVI:BEEP?

ENVI:BEEP < ON | OFF >

Parameter: ON ---- on

OFF ---- off

Example: SYS:ENVI:BEEP ON ----Turn on system beeper sound

SYS:ENVI:BEEP? ----Back to the beeper switch state

Temperature Display

- ◆ Description: Used to set the temperature display mode

Syntax: ENVI:TMODE?

ENVI:TMODE< CE | FA >

Parameter: CE ---- degree Celsius

FA ---- Fahrenheit

Example: SYS:ENVI:TMODE CE----Set the temperature display in degree Celsius

SYS:ENVI:TMODE? ----Back to the temperature display setting

Time & Date

- ◆ Description: Used to set the system time and date

Syntax: ENVI:DATETIME?

ENVI:DATETIME < m > n > a > b > c > d >

Parameter: m ---- year

n ---- month

a ---- day

b ---- hour

c ---- minute

d ---- second

Example: SYS:ENVI:DATETIME 2021,8,10,9,25,30

-----Set the system time and date
to 2021, Aug,10th, 09:25:30

SYS:ENVI:DATETIME? -----Back to the system time and
date

Measurement Mode

◆ Description: Used to set the measurement mode

Syntax: MEAS:MODE?

MEAS:MODE< CONT | SING >

Parameter: CONT ---- Continuous

SING ---- Single

Example: SYS:MEAS:MODE CONT -----Set the measurement mode
to continuous

SYS:MEAS:MODE? -----Back to the current
measurement mode

Trigger Delay

Description: Used to set the trigger delay

Syntax: TRIG:DELAY?

TRIG:DELAY < float >

Parameter: float ---- Float data type

Example: SYS:TRIG:DELAY 0.2 ----Set the trigger delay time to 0.2s
 SYS:TRIG:DELAY? ----Back to the trigger delay time

Trigger Space

- ◆ Description: Used to set the trigger space time

Syntax: TRIG:SPACE?

TRIG:SPACE < float >

Parameter: float ---- Float data type

Example: SYS:TRIG:SPACE 0.2 ----Set the trigger space to 0.2s
 SYS:TRIG:SPACE? ----Back to the trigger space

VS Delay

- ◆ Description: Used to set the delay when voltage source starts

Syntax: SOUR:DELAY?

SOUR:DELAY < float >

Parameter: float ---- Float data type

Example: SYS: SOUR:DELAY 0.2 ---- Set the delay time to 0.2s
 SYS: SOUR:DELAY? ---- Back to the delay time

Measurement Range Speed

- ◆ Description: Used to set the speed to switch between measurement ranges

Syntax: RANGE:SPEED?

RANGE:SPEED < STAND | QUICK >

Parameter: STAND ---- normal

QUICK ---- fast

Example: SYS: RANGE:SPEED STAND ---- Set the range switching
 speed to normal

SYS: RANGE:SPEED? ----Back to the range switching
speed

Analog Output

- ◆ Description: Used to set the parameters for analog output

Syntax: ANALOG?

ANALOG < IM | VM >

Parameter: IM ---- current or charge

VM ---- voltage

Example: SYS: ANALOG IM ----Set the analog output to current or
charge

SYS: ANALOG? ---- Back to analog output

Save Data

- ◆ Description: Used to save measurement data as CSV format to flash drives

Syntax: SAVE?

SAVE < ON | OFF >

Parameter: ON ---- turn on data save

OFF ---- turn off data save

Example: SYS: SAVE ON ---- Turn on data save.

SYS: SAVE? ---- Inquire the save data.

Interlock Switch

- ◆ Description: Used to turn on and off the interlock function

Syntax: INTERLOCK?

INTERLOCK < ON | OFF >

Parameter: ON ---- turn on the interlock function

OFF ---- turn off the interlock function

Example: SYS: INTERLOCK ON ----Turn on the interlock function.

SYS: INTERLOCK? ----Inquire the interlock function.

Display Bit

- ◆ Description: Used to change the display bit for the measurement

Syntax: DISP?

DISP < 3 | 4 | 5 | 6 >

Parameter: 3 ---- display in 3½ bit

4 ---- display in 4½ bit

5 ---- display in 5½ bit

6 ---- display in 6½ bit

Example: SYS: DISP 6 ---- display results in 6½ bit

SYS: DISP? ---- inquire the display bit

Error Handling

- ◆ Description: Set whether the instrument requires to solve errors manually

Syntax: HANDERROR?

HANDERROR < ON | OFF >

Parameter: ON ---- need to turn alert off manually

OFF ---- no need to turn alert off manually

Example: SYS: HANDERROR ON ---- Need to turn alert off
manually

SYS: HANDERROR? ---- Inquire the error solving
method

6.6.16 HANDLER Settings Command Set

PIN1 Settings

- ◆ Description: Used to define HANDLER-PIN1 input

Syntax: PIN1:SIG?

PIN1:SIG < START | STOP | RESET | SRCON | SRCOFF |
SRCTRG >

Parameter: START ---- start measurement

STOP ---- stop measurement

RESET ---- instrument reset

SRCON ---- voltage source on

SRCOFF ---- voltage source off

SRCTRG ---- voltage source trigger

Example: HAND: PIN1:SIG START ---- Define the PIN1 input to start
measurement

HAND: PIN1:SIG? ---- Back to the PIN1 input definition

PIN2 Settings

- ◆ Description: Used to define the HANDLER-PIN2 input

Syntax: PIN2:SIG?

PIN2:SIG < START | STOP | RESET | SRCON | SRCOFF |
SRCTRG >

Parameter: START ---- start measurement

STOP ---- stop measurement

RESET ---- instrument reset

SRCON ---- voltage source on

SRCOFF ---- voltage source off

SRCTRG ---- voltage source trigger

Example: HAND: PIN2:SIG START ---- Define PIN2 input as start measurement

HAND: PIN2:SIG? ----Back to the PIN2 input definition

PIN3 Settings

◆ Description: Used to define the HANDEL-PIN3 input

Syntax: PIN3:SIG?

PIN3:SIG < START | STOP | RESET | SRCON | SRCOFF | SRCTRG >

Parameter: START ---- start measurement

STOP ---- stop measurement

RESET ---- instrument reset

SRCON ---- voltage source on

SRCOFF ---- voltage source off

SRCTRG ---- voltage source trigger

Example: HAND: PIN3:SIG START ---- Define the PIN3 input as start measurement

HAND: PIN3:SIG? ----Back to the PIN3 input definition

PIN4~7 Settings

◆ Description: Used to define the HANDLER-PIN4~7 inputs

Syntax: PIN4:LEV?

PIN4:LEV < LEVEL | PULSE >

Parameter: LEVEL ---- level input

PULSE ---- pulse input

Example: HAND: PIN4:LEV LEVEL ---- Define the PIN4~7 inputs as
level input

 HAND: PIN4:LEV? ----Back to the PIN4~7 input
 definition

6.6.17 FETCH Inquiry Command Set

Voltage Inquiry

- ◆ Description: Used to check the current voltage measurement value

Syntax: FETCH:VOLT?

Current Inquiry

- ◆ Description: Used to check the current current measurement value

Syntax: FETCH:CURR?

Charge Inquiry

- ◆ Description: Used to check the current charge measurement value

Syntax: FETCH:CHAR?

Resistance Inquiry

- ◆ Description: Used to check the current resistance measurement value

Syntax: FETCH:RES?

Time Inquiry

- ◆ Description: Used to check the current time

Syntax: FETCH:TIME?

Voltage Source Inquiry

- ◆ Description: Used to check the current voltage source

Syntax: FETCH:SOUR?

MATH Inquiry

- ◆ Description: Used to check the current MATH

Syntax: FETCH:MATH?

Temperature Inquiry

- ◆ Description: Used to check the current temperature

Syntax: FETCH:TEMP?

Humidity Inquiry

- ◆ Description: Used to check the current humidity

Syntax: FETCH:HUM?

All Values Inquiry

- ◆ Description: Used to check all the above measurement values

Syntax: FETCH:ALL?

Example (TH2690) : Values are: 1 voltage, 2 current, 3 charge, 4 resistance, 5 time & date, 6 voltage source, 7 MATH, 8 temperature, 9 humidity

Example (TH2690A) : Values are: 1 voltage, 2 current, 3 charge, 4 time & date, 5 voltage source, 6 MATH, 7 temperature, 8 humidity

Example (TH2691&TH2691A) : Values are: 1 current, 2 time & date, 3 MATH

All Values Inquiry (with error code)

- ◆ Description: Used to check all the above measurement values, including error codes at the end

Syntax: FETCH:ALL_S?

Example (TH2690) : Values are: 1 voltage, 2 current, 3 charge, 4 resistance, 5 time & date, 6 voltage source, 7 MATH, 8 temperature, 9 humidity, 10 error code

Example (TH2690A) : Values are: 1 voltage, 2 current, 3 resistance, 4 time & date, 5 voltage source, 6 MATH, 7 temperature, 8 humidity, 9 error code

Example (TH2691&TH2691A) : Values are: 1 current, 2 time & date, 3

MATH, 4 error code

Clear Error Code

- ◆ Description: When querying using FETCH:ALL_S?, if the last parameter is non zero(indicating error), send the clear error code

Syntax: HAND:ERROR

6.7 MODBUS Commands

6.7.1 Write Commands

Send Format

Instrument Address	Function Code	Address High	Address Low	Register High Bit	Register Low Bit	Bit Length	Data Bit 1	Data Bit n	CRC Low	CRC High
--------------------	---------------	--------------	-------------	-------------------	------------------	------------	------------	-------	------------	---------	----------

Return Format

Instrument Address	Function Code	Address High	Address Low	Register High	Register Low	CRC Low	CRC High
--------------------	---------------	--------------	-------------	---------------	--------------	---------	----------

6.7.2 Read Commands

Send Format

Instrument Address	Function Code	Address High	Address Low	Register High	Register Low	CRC Low	CRC High
--------------------	---------------	--------------	-------------	---------------	--------------	---------	----------

Return Format

Instrument Address	Function Code	Bit Length	Data Bit 1	Data Bit n	CRC Low	CRC High
--------------------	---------------	------------	------------	-------	------------	---------	----------

Instrument Address: Refers to the local address of the instrument, can be set in the communication setting interface of the instrument, the value range is: 1~32

Function Code: This command can write one or more data, its code is: 0x10.

Address High and Address Low: Refers to the storage address of data in the instrument, which can be a real storage address or a mapped address.

Register High and Register Low: Indicates the number of registers written in this operation. The size of each register is 2 bytes.

Bytes Length: Represents the total number of bytes written in this operation.

Data Bit 1 ~ Data Bit n: write these data into the instrument.

CRC High and CRC Low: CRC 16-bit check, we use table lookup method to carry out CRC check

6.7.3 DISP Command Set

Parameter Address	Parameter Name	Write Data	Status	Description
0xB000	MEAS (measurement display interface)	0 (U16)	write	
	SETM (measurement settings interface)	1 (U16)	write	
	SYSE (system environment interface)	2 (U16)	write	
	FILE (file interface)	3 (U16)	write	
	TOOL (tool interface)	4 (U16)	write	
	SETC (setting configuration interface)	5 (U16)	write	
	SYSB (system BUS interface)	6 (U16)	write	
	SYSS (system settings interface)	7 (U16)	write	
	SETW (waveform settings interface)	8 (U16)	write	
	SYSH (HANDLER settings interface)	9 (U16)	write	
	BIN (BIN settings interface)	10 (U16)	write	
	VSF (voltage source settings interface)	11 (U16)	write	
	Inquire current interface		read	

6.7.4 FUNC Command Set

Parameter Address	Parameter Name	Write Data	Status	Description
0x1000	Set the instrument function to resistance meter	1 (U16)	Write	
	Set the instrument function to voltmeter	2 (U16)	Write	
	Set the instrument function to ammeter	3 (U16)	Write	

	Set the instrument function to electrometer	4 (U16)	Write	
	Select voltage source for the measurement settings interface	5 (U16)	Write	
	Inquire instrument function		Read	
0x1001	Turn off the voltage source	0 (U16)	Write	
	Turn on the voltage source	1 (U16)	Write	
	Inquire the voltage source status		Read	
0x1002	Turn off the ammeter	0 (U16)	Write	
	Turn on the ammeter	1 (U16)	Write	
	Inquire the ammeter status		Read	
0x1003	Turn off Offset Cancel	0 (U16)	Write	
	Turn on Offset Cancel	1 (U16)	Write	
	Inquire the Null Status		Read	
0x1004	Stop Measurement	0 (U16)	Write	
	Start Measurement	1 (U16)	Write	

6.7.5 VOLT Command Set

Parameter Address	Parameter Name	Write Data	Status	Description
0x2000	Set the voltmeter measurement range to auto	1 (U16)	Write	
	Set the voltmeter measurement range to 2V	2 (U16)	Write	
	Set the voltmeter measurement range to 20V	3 (U16)	Write	
	Inquire the voltmeter measurement range		Read	
0x2001	Set the voltmeter measurement speed to FAST	1 (U16)	Write	
	Set the voltmeter measurement speed to MID	2 (U16)	Write	
	Set the voltmeter measurement speed to SLOW	3 (U16)	Write	
	Inquire the voltmeter measurement speed		Read	
0x2002	Turn off voltmeter sorting	1 (U16)	Write	
	Turn on voltmeter sorting	2 (U16)	Write	
	Inquire voltmeter sorting		Read	
0x2003	Set the voltmeter sorting upper limit	Float	Write	
	Inquire the voltmeter sorting upper limit		Read	
0x2004	Set the voltmeter sorting lower limit	Float	Write	

	Inquire the voltmeter sorting lower limit		Read	
0x2005	Set the voltmeter guarded mode to GUARD	1 (U16)	Write	
	Set the voltmeter guarded mode to CCOM	2 (U16)	Write	
	Inquire the voltmeter guarded mode		Read	

6.7.6 CURR Command Set

Parameter Address	Parameter Name	Write Data	Status	Description
0x3000	Set the ammeter measurement range to auto	1 (U16)	Write	
	Set the ammeter measurement range to 20mA	2 (U16)	Write	
	Set the ammeter measurement range to 2mA	3 (U16)	Write	
	Set the ammeter measurement range to 200uA	4 (U16)	Write	
	Set the ammeter measurement range to 20uA	5 (U16)	Write	
	Set the ammeter measurement range to 2uA	6 (U16)	Write	
	Set the ammeter measurement range to 200nA	7 (U16)	Write	
	Set the ammeter measurement range to 20nA	8 (U16)	Write	
	Set the ammeter measurement range to 2nA	9 (U16)	Write	
	Set the ammeter measurement range to 200pA	10 (U16)	Write	
	Set the ammeter measurement range to 20pA	11 (U16)	Write	
	Inquire the ammeter measurement range		Read	
0x3001	Set the ammeter measurement speed to FAST	1 (U16)	Write	
	Set the ammeter measurement speed to MID	2 (U16)	Write	
	Set the ammeter measurement speed to SLOW	3 (U16)	Write	
	Inquire the ammeter measurement speed		Read	
0x3002	Turn off ammeter sorting	1 (U16)	Write	
	Turn on ammeter sorting	2 (U16)	Write	
	Inquire the ammeter sorting		Read	
0x3003	Set the ammeter sorting upper limit	Float	Write	
	Inquire the ammeter sorting upper limit		Read	
0x3004	Set the ammeter sorting lower limit	Float	Write	

	Inquire the ammeter sorting lower limit		Read	
--	---	--	------	--

6.7.7 RES Command Set

Parameter Address	Parameter Name	Write Data	Status	Description
0x4000	Set the resistance meter measurement range to auto	1 (U16)	Write	
	Set the resistance meter measurement range to 100TΩ	2 (U16)	Write	
	Set the resistance meter measurement range to 10TΩ	3 (U16)	Write	
	Set the resistance meter measurement range to 1TΩ	4 (U16)	Write	
	Set the resistance meter measurement range to 100GΩ	5 (U16)	Write	
	Set the resistance meter measurement range to 10GΩ	6 (U16)	Write	
	Set the resistance meter measurement range to 1GΩ	7 (U16)	Write	
	Set the resistance meter measurement range to 100MΩ	8 (U16)	Write	
	Set the resistance meter measurement range to 10MΩ	9 (U16)	Write	
	Set the resistance meter measurement range to 1MΩ	10 (U16)	Write	
	Set the resistance meter measurement range to manual	11 (U16)	Write	
	Inquire the resistance meter measurement range		Read	
0x4001	Set the resistance meter measurement speed to FAST	1 (U16)	Write	
	Set the resistance meter measurement speed to MID	2 (U16)	Write	
	Set the resistance meter measurement speed to SLOW	3 (U16)	Write	
	Inquire the resistance meter measurement speed		Read	
0x4002	Turn off the resistance meter sorting	1 (U16)	Write	
	Turn on the resistance meter sorting	2 (U16)	Write	
	Inquire the resistance meter sorting		Read	
0x4003	Set the resistance meter sorting upper limit	Float	Write	
	Inquire the resistance meter sorting upper limit		Read	
0x4004	Set the resistance meter sorting lower limit	Float	Write	
	Inquire the resistance meter sorting lower limit		Read	

0x4005	Set the resistance meter calculation mode to V_m/I_m	1 (U16)	Write	
	Set the resistance meter calculation mode to V_s/I_m	2 (U16)	Write	
	Inquire the resistance meter sorting		Read	

6.7.8 CHAR Command Set

Parameter Address	Parameter Name	Write Data	Status	Description
0x5000	Set the electrometer measurement range to 2~20nC	1 (U16)	Write	
	Set the electrometer measurement range to 0.2~2uC	2 (U16)	Write	
	Set the electrometer measurement range to 2nC	3 (U16)	Write	
	Set the electrometer measurement range to 20nC	4 (U16)	Write	
	Set the electrometer measurement range to 200nC	5 (U16)	Write	
	Set the electrometer measurement range to 2000nC	6 (U16)	Write	
	Inquire the electrometer measurement range		Read	
0x5001	Set the electrometer measurement speed to FAST	1 (U16)	Write	
	Set the electrometer measurement speed to MID	2 (U16)	Write	
	Set the electrometer measurement speed to SLOW	3 (U16)	Write	
	Inquire the electrometer measurement speed		Read	
0x5002	Turn off the charge sorting	1 (U16)	Write	
	Turn on the charge sorting	2 (U16)	Write	
	Inquire the charge sorting		Read	
0x5003	Set the charge sorting upper limit	Float	Write	
	Inquire the charge sorting upper limit		Read	
0x5004	Set the charge sorting lower limit	Float	Write	
	Inquire the charge sorting lower limit		Read	
0x5005	Turn on auto discharge	1 (U16)	Write	
	Turn off auto discharge	2 (U16)	Write	
	Inquire auto discharge		Read	
0x5006	Set the discharge level to 2nC	1 (U16)	Write	
	Set the discharge level to 2nC	2 (U16)	Write	
	Set the discharge level to 2nC	3 (U16)	Write	

	Set the discharge level to 2nC	4 (U16)	Write	
	Inquire the discharge level		Read	

6.7.9 SRC Command Set

Parameter Address	Parameter Name	Write Data	Status	Description
0x6000	Set the voltage source output value	Float	Write	
	Inquire the voltage source output value		Read	
0x6001	Set the output status to HIGHZ	1 (U16)	Write	
	Set the output status to NORMAL	2 (U16)	Write	
	Set the output status to ZERO	3 (U16)	Write	
	Inquire the output status		Read	
0x6002	Set the voltage source ground mode to CCOM	1 (U16)	Write	
	Set the voltage source ground mode to FLOAT	2 (U16)	Write	
	Inquire the voltage source ground mode		Read	
0x6003	Set the voltage source current limiting resistance to 0	1 (U16)	Write	
	Set the voltage source current limiting resistance to 20M	2 (U16)	Write	
	Inquire the voltage source current limiting resistance		Read	
0x6004	Set the source measurement range to -20~20V	1 (U16)	Write	
	Set the source measurement range to 0~1000V	2 (U16)	Write	
	Set the source measurement range-1000~0V	3 (U16)	Write	
	Inquire the source measurement range		Read	

6.7.10 FILT Command Set

Parameter Address	Parameter Name	Write Data	Status	Description
0x7000	Set the filter mode to off	1 (U16)	Write	
	Set the filter mode to average	2 (U16)	Write	
	Set the filter mode to median	3 (U16)	Write	
	Set the filter mode to slide	4 (U16)	Write	
	Inquire the filter mode		Read	
0x7001	Set the filter sample number	(U16)	Write	
	Inquire the filter sample number		Read	

6.7.11 MATH Command Set

Parameter Address	Parameter Name	Write Data	Status	Description
0x8000	Set the MATH function off	1 (U16)	Write	
	Set the MATH function to scaling migration	2 (U16)	Write	
	Set the MATH function to reciprocal scaling migration	3 (U16)	Write	
	Set the MATH function to ratio	4 (U16)	Write	
	Set the MATH function to percentage ratio	5 (U16)	Write	
	Set the MATH function to deviation	6 (U16)	Write	
	Set the MATH function to percentage deviation	7 (U16)	Write	
	Set the MATH function to Logarithm	8 (U16)	Write	
	Set the MATH function to polynomial	9 (U16)	Write	
	Inquire the MATH function		Read	
0x8001	Set the MATH function coefficient 1	Float	Write	
	Inquire the MATH function coefficient 1		Read	
0x8002	Set the MATH function coefficient 2	Float	Write	
	Inquire the MATH function coefficient 2		Read	
0x8003	Set the MATH function coefficient 3	Float	Write	
	Inquire the MATH function coefficient 3		Read	

6.7.12 WAVE Command Set

Parameter Address	Parameter Name	Write Data	Status	Description
0x9000	Turn on the waveform display	1 (U16)	Write	
	Turn off the waveform display	2 (U16)	Write	
	Inquire the waveform display		Read	
0x9001	Set the waveform to line graph	1 (U16)	Write	
	Set the waveform to histogram	2 (U16)	Write	
	Inquire the waveform type		Read	
0x9002	Set the line graph X-axis parameter to time	1 (U16)	Write	
	Set the line graph X-axis parameter to MATH	2 (U16)	Write	
	Set the line graph X-axis parameter to current	3 (U16)	Write	

	Set the line graph X-axis parameter to voltage	4 (U16)	Write	
	Set the line graph X-axis parameter to resistance	5 (U16)	Write	
	Set the line graph X-axis parameter to voltage source	6 (U16)	Write	
	Set the line graph X-axis parameter to charge	7 (U16)	Write	
	Inquire the X-axis parameter		Read	
0x9003	Set the line graph X-axis maximum	Float	Write	
	Inquire the X-axis maximum		Read	
0x9004	Set the line graph X-axis minimum	Float	Write	
	Inquire the X-axis minimum		Read	
0x9005	Set the line graph Y-axis parameter to MATH	1 (U16)	Write	
	Set the line graph Y-axis parameter to current	2 (U16)	Write	
	Set the line graph Y-axis parameter to voltage	3 (U16)	Write	
	Set the line graph Y-axis parameter to resistance	4 (U16)	Write	
	Set the line graph Y-axis parameter to charge	5 (U16)	Write	
	Inquire the Y-axis parameter		Read	
0x9006	Set the line graph Y-axis maximum	Float	Write	
	Inquire the line graph Y-axis maximum		Read	
0x9007	Set the line graph Y-axis minimum	Float	Write	
	Inquire the line graph Y-axis minimum		Read	
0x9008	Turn on auto ratio	1 (U16)	Write	
	Turn off auto ratio	2 (U16)	Write	
	Inquire auto ratio		Read	
0x9009	Set the histogram X-axis parameter to MATH	1 (U16)	Write	
	Set the histogram X-axis parameter to current	2 (U16)	Write	
	Set the histogram X-axis parameter to voltage	3 (U16)	Write	
	Set the histogram X-axis parameter to resistance	4 (U16)	Write	
	Set the histogram X-axis parameter to charge	5 (U16)	Write	
	Inquire the histogram X-axis parameter		Read	

6.7.13 BIN Command Set

Parameter Address	Parameter Name	Write Data	Status	Description
0xE000	Turn on limit test	1 (U16)	Write	
	Turn off limit test	2 (U16)	Write	
	Inquire limit test		Read	
0xE001	Set the limit mode to GRADING	1 (U16)	Write	
	Set the limit mode to SORTING	2 (U16)	Write	
	Inquire the limit mode		Read	
0xE002	Set the limit parameter to current	1 (U16)	Write	
	Set the limit parameter to voltage	2 (U16)	Write	
	Set the limit parameter to resistance	3 (U16)	Write	
	Set the limit parameter to charge	4 (U16)	Write	
	Inquire the limit parameter type		Read	
0xE003	Set the BIN index	(U16)	Write	1~7
	Inquire the BIN index		Read	
0xE004	Turn off the current index BIN	1 (U16)	Write	
	Turn on the current index BIN	2 (U16)	Write	
	Inquire the current index BIN switch		Read	
0xE005	Set the current fail on range to IN	1 (U16)	Write	
	Set the current fail on range to OUT	2 (U16)	Write	
	Inquire the current fail on range		Read	
0xE006	Set the current index pass pattern	(U16)	Write	1~14
	Inquire the current index pass pattern		Read	
0xE007	Set the current index fail pattern	(U16)	Write	1~14
	Inquire the current index fail pattern		Read	
0xE008	Set the current index upper limit	Float	Write	
	Inquire the current index upper limit		Read	
0xE009	Set the current index lower limit	Float	Write	
	Inquire the current index lower limit		Read	

6.7.14 VSFUNC Command Set

Parameter Address	Parameter Name	Write Data	Status	Description
0xF000	Turn off waveform output	1 (U16)	Write	

	Set the waveform output to single staircase sweep	2 (U16)	Write	
	Set the waveform output to double staircase sweep	3 (U16)	Write	
	Set the waveform output to square wave	4 (U16)	Write	
	Set the waveform output to list sweep	5 (U16)	Write	
	Inquire the waveform output type		Read	
0xF001	Set the single staircase sweep starting voltage	Float	Write	
	Inquire the single staircase sweep starting voltage		Read	
0xF002	Set the single staircase sweep stopping voltage	Float	Write	
	Inquire the single staircase sweep stopping voltage		Read	
0xF003	Set the single staircase sweep stepping voltage	Float	Write	
	Inquire the single staircase sweep stepping voltage		Read	
0xF004	Set the single staircase sweep trigger mode to trigger	1 (U16)	Write	
	Set the single staircase sweep trigger mode to timer	2 (U16)	Write	
	Inquire the single staircase sweep trigger mode		Read	
0xF005	Set the single staircase sweep timer	Float	Write	
	Inquire the single staircase sweep timer		Read	
0xF006	Set the double staircase sweep starting voltage	Float	Write	
	Inquire the double staircase sweep starting voltage		Read	
0xF007	Set the double staircase sweep stopping voltage	Float	Write	
	Inquire the double staircase sweep stopping voltage		Read	
0xF008	Set the double staircase sweep stepping voltage	Float	Write	
	Inquire the double staircase sweep stepping voltage		Read	
0xF009	Set the double staircase sweep trigger mode to trigger	1 (U16)	Write	
	Set the double staircase sweep trigger mode to timer	2 (U16)	Write	
	Inquire the double staircase sweep trigger mode		Read	

0xF00A	Set the double staircase sweep timer	Float	Write	
	Inquire the double staircase sweep timer		Read	
0xF00B	Set the square wave starting voltage	Float	Write	
	Inquire the square wave starting voltage		Read	
0xF00C	Set the square wave starting delay	Float	Write	
	Inquire the square wave starting delay		Read	
0xF00D	Set the square wave peak voltage	Float	Write	
	Inquire the square wave peak voltage		Read	
0xF00E	Set the square wave peak delay	Float	Write	
	Inquire the square wave delay		Read	
0xF00F	Set the square wave ending time	Float	Write	
	Inquire the square wave ending time		Read	
0xF010	Set the square wave loop count	(U16)	Write	≥ 1
	Inquire the square wave loop count		Read	
0xF011	Set the list begin number	(U16)	Write	1~100
	Inquire the list begin number		Read	
0xF012	Set the list end number	(U16)	Write	1~100
	Inquire the list end number		Read	
0xF013	Set the list loop count	(U16)	Write	≥ 1
	Inquire the list loop count		Read	
0xF014	Set the list step index	(U16)	Write	1~100
	Inquire the list step index		Read	
0xF015	Set the current list index voltage	Float	Write	
	Inquire the current list index voltage		Read	
0xF016	Set the current list index time	Float	Write	
	Inquire the current list index time		Read	

6.7.15 SYS Command Set

Parameter Address	Parameter Name	Write Data	Status	Description
0xA000	Set the system language to Chinese	1 (U16)	Write	

	Set the system language to English	2 (U16)	Write	
	Inquire the system language		Read	
0xA001	Turn on the system beeper on	1 (U16)	Write	
	Turn off the system beeper	2 (U16)	Write	
	Inquire the system beeper		Read	
0xA002	Set the temperature display in degree celsius	1 (U16)	Write	
	Set the temperature display in fahrenheit	2 (U16)	Write	
	Inquire the temperature display		Read	
0xA003	Set the measurement mode to continuous	1 (U16)	Write	
	Set the measurement mode to single	2 (U16)	Write	
	Inquire the measurement mode		Read	
0xA004	Set the trigger delay	Float	Write	
	Inquire the trigger delay		Read	
0xA005	Set the trigger period	Float	Write	
	Inquire the trigger period		Read	
0xA006	Set the voltage source delay	Float	Write	
	Inquire the voltage source delay		Read	
0xA007	Set the measurement range switching speed to normal	1 (U16)	Write	
	Set the measurement range switching speed to fast	2 (U16)	Write	
	Inquire the measurement range switching speed		Read	
0xA008	Set the analog output to current or charge	1 (U16)	Write	
	Set the analog output to voltage	2 (U16)	Write	
	Inquire the analog output		Read	
0xA009	Turn on data save	1 (U16)	Write	
	Turn off data save	2 (U16)	Write	
	Inquire the data save		Read	
0xA00A	Turn on the interlock function	1 (U16)	Write	
	Turn off the interlock function	2 (U16)	Write	
	Inquire the interlock function		Read	
0xA00B	Display in 3½ bit	1 (U16)	Write	
	Display in 4½ bit	2 (U16)	Write	
	Display in 5½ bit	3 (U16)	Write	
	Display in 6½ bit	4 (U16)	Write	
	Inquire the display bit		Read	
0xA00C	Error handling on	1 (U16)	Write	
	Error handling off	2 (U16)	Write	
	Inquire error handling		Read	

6.7.16 HANDLER Command Set

Parameter Address	Parameter Name	Write Data	Status	Description
0xC000	Set PIN1 to start measurement	1 (U16)	Write	
	Set PIN1 to stop measurement	2 (U16)	Write	
	Set PIN1 to reset	3 (U16)	Write	
	Set PIN1 to start voltage source	4 (U16)	Write	
	Set PIN1 to stop voltage source	5 (U16)	Write	
	Set PIN1 to trigger source	6 (U16)	Write	
	Inquire the PIN1 input signal		Read	
0xC001	Set PIN2 to start measurement	1 (U16)	Write	
	Set PIN2 to stop measurement	2 (U16)	Write	
	Set PIN2 to reset	3 (U16)	Write	
	Set PIN2 to start voltage source	4 (U16)	Write	
	Set PIN2 to stop voltage source	5 (U16)	Write	
	Set PIN2 to trigger source	6 (U16)	Write	
	Inquire the PIN2 input signal		Read	
0xC002	Set PIN3 to start measurement	1 (U16)	Write	1~7
	Set PIN3 to stop measurement	2 (U16)	Write	
	Set PIN3 to reset	3 (U16)	Write	
	Set PIN3 to start voltage source	4 (U16)	Write	
	Set PIN3 to stop voltage source	5 (U16)	Write	
	Set PIN3 to trigger source	6 (U16)	Write	
	Inquire the PIN3 input signal		Read	
0xC003	Set PIN4~7 output levels	1 (U16)	Write	
	Set PIN4~7 output pulses	2 (U16)	Write	
	Inquire the PIN4~7 output		Read	

6.7.17 FETCH Command Set

Parameter Address	Parameter Name	Write Data	Status	Description
0xD000	Inquire voltage value		Read	Float
0xD001	Inquire current value		Read	Float
0xD002	Inquire charge value		Read	Float
0xD003	Inquire resistance value		Read	Float
0xD004	Inquire voltage source value		Read	Float
0xD005	Inquire MATH		Read	Float
0xD006	Inquire temperature		Read	Float
0xD007	Inquire humidity		Read	Float

Chapter 7 Technical Parameter Specifications

7.1 Main Technical Specifications

Model	Femtometer/Electrometer/Resistance meter	Picoammeter/insulation resistance meter	Femtometer	Picoammeter
	TH2690	TH2690A	TH2691	TH2691A
Measurement Resolution	6½ bit	6½ bit	6½ bit	6½ bit
Current Measurement	0.1 fA - 20 mA	1 fA - 20mA	0.1 fA - 20 mA	1 fA – 20mA
Minimum Measurement Range	20 pA	2 nA	20 pA	2 nA
Resistance Measurement	Max 1 PΩ	Max 10 TΩ	-	-
Voltage Measurement	1 μV - 20 V	1 μV - 20 V	-	-
Input Resistance	> 200 TΩ	> 200 TΩ	-	-
Charge Measurement	1 fC - 2 μC	-	-	-
Temperature Measurement	√	√	-	-
Humidity Measurement	√	√	-	-
Voltage Source	±1,000 V	±1,000 V	-	-
Minimum Resolution	700 μV	700 μV	-	-

7.2 Detailed Technical Specifications

Conditions : temperature: 23°C ±5°C

humidity: 30%~80%RH

After 1 hour of pre-heating

Ambient temperature variation: less than ±3°C after self-calibration

Calibration Cycle: 1 year

Current Measurement Accuracy:

Measurement Range	Display Resolution	Accuracy± (%+deviation)
20pA	0.1fA	1%+5fA
200pA	0.1fA	0.5%+5fA
2nA	1fA	0.2%+50fA
20nA	10fA	0.2%+3pA
200nA	100fA	0.2%+5pA

2 μ A	1pA	0.1%+50pA
20 μ A	10pA	0.05%+500pA
200 μ A	100pA	0.05%+5nA
2mA	1nA	0.05%+50nA
20mA	10nA	0.05%+500nA

NOTE: TH2690A and TH2691A do not support 20pA and 200pA.

Resistance Measurement Accuracy:

Measurement Range	Display Resolution	Voltage Source	Current Measurement Range	Accuracy \pm (%+deviation)
1M Ω	1 Ω	20V	200 μ A	0.135%+1 Ω
10M Ω	10 Ω	20V	20 μ A	0.135%+10 Ω
100M Ω	100 Ω	20V	2 μ A	0.185%+100 Ω
1G Ω	1k Ω	20V	200nA	0.285%+1k Ω
10G Ω	10k Ω	20V	20nA	0.41%+10k Ω
100G Ω	100k Ω	20V	2nA	0.41%+100k Ω
1T Ω	1M Ω	200V	2nA	0.45%+1M Ω
10T Ω	10M Ω	200V	200pA	0.75%+10M Ω
100T Ω	100M Ω	200V	20pA	2.6%+100M Ω

NOTE: 1. These specifications are only for auto measurement range mode.

2. TH2690A does not support 10T Ω and 100T Ω , TH2691 and TH2691A does not support resistance measurement function.

Voltage Measurement Accuracy:

Measurement Range	Display Resolution	Accuracy \pm (%+deviation)
2V	1 μ V	0.05%+40 μ V
20V	10 μ V	0.05%+400 μ V

NOTE: TH2691 and TH2691A does not support voltage measurement function.

Charge Measurement Accuracy:

Measurement Range	Display Resolution	Accuracy \pm (%+deviation)
2nC	1fC	0.5%+50fC
20nC	10fC	0.5%+500fC
200nC	100fC	0.5%+5pC
2 μ C	1pC	0.5%+50pC

NOTE: 1. Only TH2690 supports charge measurement function.

2. Specifications are valid within 1s.

Voltage Source Accuracy:

Voltage Source Measurement Range	Display Resolution	Accuracy \pm (%+deviation)	Maximum Output Current
20V	700 μ V	0.05%+2mV	\pm 20mA
1000V	35mV	0.05%+100mV	\pm 1mA

NOTE: TH2691 and TH2691A does not support voltage source output function

Chapter 8 Warranty

Warranty period: For the user, who buys the instrument from the company, the warranty period is calculated from the date of shipment of the company; for the purchaser from the self-operating department, it is calculated from the date of shipment of the self-operating department. The warranty period is two years. Warranty card is issued for the instrument. During the warranty period, if the instrument is damaged due to improper operation by the user, the maintenance cost will be borne by the user. The company is responsible for lifetime maintenance of the instrument.

The maintenance of the instrument requires professional and technician to carry out maintenance; during maintenance, please do not replace the internal components of the instrument without authorization; after the maintenance of the instrument, it is necessary to re-measure and calibrate so as not to affect the measurement accuracy. Damage caused by the replacement of instrument parts or misbehaviour on maintenance does not fall within the scope of warranty, and the user shall bear the maintenance costs.

The instrument should be protected from the sun and moisture and should be properly used in the environment described in 1.2.

If the instrument is not used for a long time, it should be packed and sealed up in the packing box.