

OPERATION MANUAL

TH1951

5¹/₂ Digit Multimeter

Changzhou Tonghui Electronic Co., Ltd.

www.tonghui.com.cn

Manual Printing History

The manual printing data and part number indicate its current edition. The printing date changes when a new edition is printed. The manual part number changes when extensive technical changes are incorporated.

March 2006 First Edition

April 2007 Second Edition

October 2008.....Third Edition

Notice

The information contained in this document is subject to change without notice.

Safety notice supplement

As described in the International Electrotechnical Commission (IEC) Standard IEC 664, digital multimeter measuring circuits (e.g., Tonghui Models 1951, 1961, 1941, and 1942) are Installation Category II. All other instruments' signal terminals are Installation Category I and must not be connected to mains.

This equipment is POLLUTION DEGREE 2, INDOOR USE product.

Safety Precautions

Users of this product must be protected from electric shock at all times. The responsible body must ensure that users are prevented access and/or insulated from every connection point. In some cases, connections must be exposed to potential human contact. Product users in these circumstances must be trained to protect themselves from the risk of electric shock. If the circuit is capable of operating at or above 1000 volts, no conductive part of the circuit may be exposed.

Before operating an instrument, make sure the line cord is connected to a properly grounded power receptacle. Inspect the connecting cables, test leads, and jumpers for possible wear. Cracks, or breaks before each use.

For maximum safety, do not touch the product, test cables, or any other instruments while power is applied to the circuit under test. ALWAYS remove power from the entire test system and discharge any capacitors before: connecting or disconnecting cables or jumpers, or making internal changes, such as installing or removing jumpers.

Do not touch any object that could provide a current path to the common side of the circuit under test or power line (earth) ground. Always make measurements with dry hands while standing on a dry, insulated surface capable of withstanding the voltage being measured.

The instrument and accessories must be used in accordance with its specifications and operating instructions or the safety of the equipment may be impaired.

Do not exceed the maximum signal levels of the instruments and accessories, as defined in the specifications and operating information, and as shown on the instrument or test fixture panels.

When fuses are used in a product, replace with the same type and rating for continued protection against fire hazard.

Chassis connections must only be used as shield connections for measuring circuits, NOT as safety earth ground connections.

If you are using a test fixture, keep the lid closed while power is applied to the device under test.

Contents

Chapter 1 General Information	7
1.1 Feature Overview.....	7
1.2 Operating Environment	7
1.3 Dimensions and Weight	7
1.4 Safety symbols and Precautions	8
1.5 Incoming Inspection	8
1.6 Warranty	9
1.7 Limitation of Warranty	9
Chapter 2 TH1951 Overview.....	10
2.1 Front Panel Summary	10
2.2 Annunciators on Screen	11
2.3 Front Panel Menu Reference	12
2.4 Front Panel Menu Overview.....	14
2.5 Rear Panel Summary	15
2.6 Power up.....	16
2.6.1 Power Line Connection	16
2.6.2 Power-up Sequence	16
2.6.3 High Energy Circuit Safety Precautions	16
2.6.4 Power-on Defaults.....	17
2.6.5 Warm-up time	19
2.7 Display.....	19
Chapter 3 Basic Measurements	20
3.1 Preparation.....	20
3.2 Measuring Voltage	20
3.2.1 Connections	20
3.2.2 Crest factor.....	21
3.3 Measuring Current.....	21
3.3.1 Connections	22
3.3.2 Front Panel Fuse Replacement	23
3.4 Measuring Resistance	23
3.4.1 Connections	23
3.4.2 Shielding.....	24
3.5 Measuring Frequency and Period	24
3.5.1 Trigger Level and Measurement Errors	25
3.5.2 Gate Time	25
3.5.3 Connections	25
3.6 Measuring Continuity	26
3.6.1 Connections	26
3.6.2 Threshold resistance level	26
3.7 Testing Diode.....	27
3.7.1 Connections	27
3.7.2 Current Range	27

3.8 Math Functions	28
3.8.1 $mX+b$	28
3.8.2 Percent	29
3.8.3 dB Calculation.....	30
3.8.4 dBm Calculation	30
Chapter 4 Measurement Options	32
4.1 Measurement configuration	32
4.1.1 Range	32
4.1.2 Filter	33
4.1.3 Relative.....	34
4.1.4 Rate.....	35
4.2 Trigger Operations	36
4.2.1 Trigger model.....	36
4.2.2 Reading Hold.....	38
4.2.3 EXT Trig & VM Comp.....	39
4.3 Buffer Operations	40
4.3.1 Storing Reading.....	40
4.3.2 Recalling Readings.....	40
4.3.3 Buffer statistics	41
4.4 Limit Operations.....	41
4.4.1 Enabling limits.....	41
4.4.2 Setting Limit Values	42
4.5 System Operations.....	43
4.5.1 Beeper Control	43
4.5.2 Save Settings.....	43
4.5.3 Restore Settings.....	44
4.5.4 Display Control	44
4.5.5 Key Sound.....	45
4.5.6 Self-test.....	45
4.5.7 Calibration	45
Chapter 5 Remote Operation	47
5.1 Selecting an interface.....	47
5.1.1 USB.....	47
5.1.2 RS-232.....	47
5.1.3 GPIB.....	48
5.2 RS-232 Interface Operation.....	48
5.2.1 RS-232 Connection	48
5.2.2 Sending and receiving data	50
5.2.3 Selecting Baud Rate.....	50
5.2.4 Selecting the Parity Mode.....	51
5.2.5 Selecting the Terminal Character.....	51
5.2.6 Software Handshake ON/OFF	52
5.2.7 Software Protocol.....	52
5.3 GPIB interface operation	53

5.3.1 GPIB Connection	53
5.3.2 GPIB Interface Capability	54
5.3.3 GPIB Addressing	54
5.3.4 General Bus Commands	55
5.4 Data Format	55
Chapter 6 SCPI Command Reference	56
6.1 Command structure	56
6.2 Command Syntax	56
6.2.1 Commands and command parameters	56
6.2.2 Short-form Rules	58
6.2.3 Basic Rules of Command Structure	58
6.2.4 Multiple Command Rules	59
6.2.5 Command Path Rules	59
6.3 Command Reference	59
6.3.1 SCPI Signal Oriented Measurement Commands	59
6.3.2 DISPlay subsystem	62
6.3.3 CALCulate Subsystem	63
6.3.4 SENSE subsystem command	70
6.3.5 SYSTem Subsystem	83
6.3.6 UNIT Subsystem	85
6.3.7 TRIGger Subsystem	88
6.3.8 R Subsystem	91
6.3.9 Common Commands	91
Chapter 7 Specifications	92
Chapter 8 Program Examples	101
Chapter 9 Error Messages	104

Chapter 1 General Information

Thanks very much for choosing and using our product. If you have any questions after reviewing this manual, please contact your local representative or call directly to our application engineers for further consultation.

1.1 Feature Overview

TH1951 is a 5½ digital multimeter with high accuracy, stability and speed. The multimeter can provides a maximum measurement speed of 1000 readings/sec. TH1951 has a 0.01% DC voltage basic accuracy, 0.03% basic resistance accuracy and other high performance. TH1951 has broad measurement ranges:

- DC voltage from 1μV to 1000V
- AC (RMS) voltage from 1μV to 750V, or about 1000V Peak
- DC current from 100nA to 12A
- AC (RMS) current from 100nA to 12A
- Two and four-wire resistance from 1mΩ to 120MΩ
- Frequency from 5Hz to 1MHz

Some additional capabilities of Model TH1951:

- Full range of functions: In addition to those listed above, The TH1951 functions include period, dB, dBm, continuity, diode testing, mX+b and percent.
- Programming languages and remote control interfaces: The TH1951 provides the SCPI programming language and three remote control interface ports: USB Device、IEEE-488/GPIB (optional) and RS-232C(optional).
- Reading and setup storage: Up to 512 readings and 10 sets of settings can be stored and retrieved.
- Closed-cover calibration: The multimeter can be calibrated either from the front panel or through the remote control interface.

1.2 Operating Environment

Power supply: 110V/220V ±10%

Line frequency: 50Hz / 60Hz ±5%

Power consumption: <20VA

Operating temperature: 0°C to 40°C

Humidity: ≤ 90%RH

1.3 Dimensions and Weight

Dimensions (W×H×D): 225mm×100mm×355mm

Net weight: Around 2.5Kg

1.4 Safety symbols and Precautions

The  symbol on the instrument indicates that user should refer to the operating instructions located in the manual before performing.

The  symbol on the instrument shows that high voltage may be present on the terminal(s). Be careful to avoid personal contact with these voltages.

The symbol  on the instruments means earth grounding.

The **WARNING** heading used in the manual explains high voltage danger that might result in personal injury or death. Always read the associated information very carefully before performing the indicated procedure.

The **CAUTION** heading in the manual reminds user that hazards could damage the instruments if not according to operating instructions. Such damage may invalidate the warranty.

1.5 Incoming Inspection

The TH1951 was carefully inspected mechanically and electrically before shipment. After unpacking all items from the shipping carton, please check for any obvious signs of physical damage that may have occurred during transportation. Report any damage to the shipping agent immediately. Save the original packing carton for possible future reshipment. The following items are included with every Model TH1951 order:

- Model TH1951 5¹/₂ Digital Multimeter
- Test leads (Model TH26036)
- Power cord
- Two 500mA fuses
- Two 1A fuses
- Operation Manual
- Quality and warranty certificate
- Test report
- Other optional accessories if ordered

Verify that you have received all the items above when you get multimeter. If anything is missing, please contact our representative or our sales office.

Note: *IEEE-488 and RS232C interface is optional, additional order is needed.*

1.6 Warranty

Tonghui warrants this product to be free from defects in material and workmanship for a period of 2 years from the date of shipment. During the warranty period, we will, at our option, either repair or replace any product that proves to be defective.

1.7 Limitation of Warranty

This warranty does not apply to defects resulting from product modification without our express written consent, or misuse of any product or part. This warranty also does not apply to fuses, software, or problems arising from normal wear or failure to follow instructions.

THIS WARRANTY IS IN LIEU OF ALL OTHER WARRANTIES, EXPRESSED OR IMPLIED, INCLUDING ANY IMPLIED WARRANTY OF MERCHANTABILITY OR FITNESS FOR A PARTICULAR USE. THE REMEDIES PROVIDED HEREIN ARE BUYER'S SOLE AND EXCLUSIVE REMEDIES.

NEITHER TONGHUI ELECTRONICS NOR ANY OF ITS EMPLOYEES SHALL BE LIABLE FOR ANY DIRECT, INDIRECT, SPECIAL, INCIDENTAL OR CONSEQUENTIAL DAMAGES ARISING OUT OF THE USE OF ITS INSTRUMENTS AND SOFTWARE EVEN IF TONGHUI ELECTRONICS HAS BEEN ADVISED IN ADVANCE OF THE POSSIBILITY OF SUCH DAMAGES. SUCH EXCLUDED DAMAGES SHALL INCLUDE, BUT ARE NOT LIMITED TO: COSTS OF REMOVAL AND INSTALLATION, LOSSES SUSTAINED AS THE RESULT OF INJURY TO ANY PERSON, OR DAMAGE TO PROPERTY.

Chapter 2 TH1951 Overview

2.1 Front Panel Summary

The front panel of the TH1951 is shown in Figure 2-1. This figure includes some important abbreviated information that should be reviewed before operating the instrument.

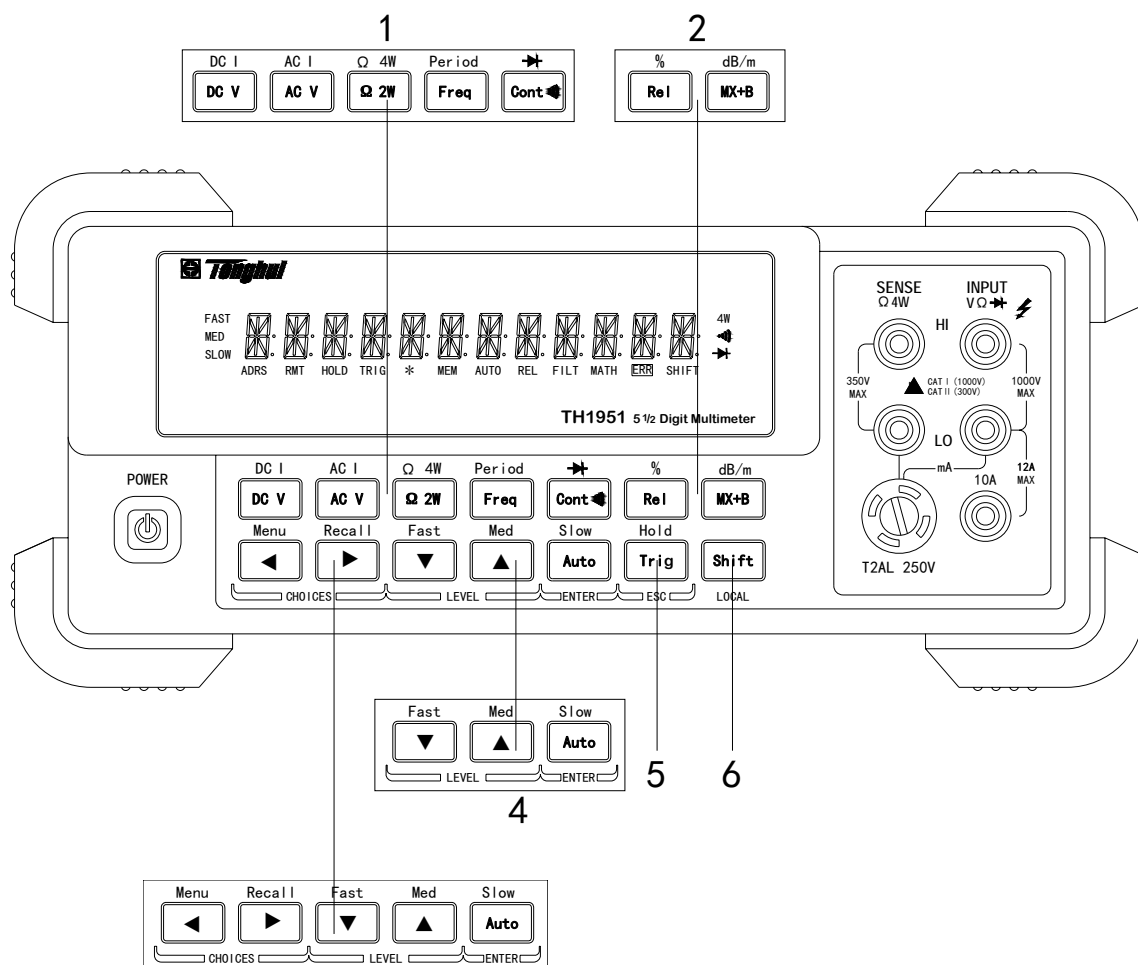





















Figure 2-1 TH1951 Front Panel

1. Measurement function keys (shifted and unshifted)
Select measurement function: DC voltage and current, AC voltage and current, 2-wire and 4-wire resistance, frequency, period, continuity and diode test.
2. Math function keys
Select the math function: $mX+b$, %, dB, dBm and Rel.
3. Menu operation keys

Shift	→	←	Open/Close menu
Shift	→	→	Recall the menu performed last time.
←			Move through selections within menu level, command level or parameter level

-  Move through selections within menu level, command level or parameter level.
 -  Move up a level.
 -  Move down a level.
 -  (ENTER) Save the change made on “parameter” level, and return to the “command” level.
 -  (ESC) Cancel the change made on “parameter” level, and return to the “command” level.
4. Range and measurement speed keys
-  Select a higher range and disable auto ranging.
 -  Select a lower range and disable auto ranging.
 -  Toggle between auto ranging and manual ranging.
 -  →  Set measurement speed to Fast.
 -  →  Set measurement speed to Medium.
 -  →  Set measurement speed to Slow.
5. Trig/Hold Key
-  Trigger a measurement from the front panel.
 -  →  Hold a stable reading on the display when selected numbers of samples are within the selected tolerance.
6. Shift/Local keys
-  Used to access shifted keys.
 -  (LOCAL) Cancel GPIB or RS232C remote control mode and back to the LOCAL mode..

2.2 Annunciators on Screen



Figure 2-2 Display Annunciators

- * (asterisk) Reading being stored
- (Diode) Instrument is in diode testing function
-))) (Speaker) Beeper on for continuity testing function
- 4W Multimeter is in 4-wire resistance function.
- ADRS Multimeter is addressed to listen or talk over the GPIB interface
- AUTO Auto ranging enabled
- ERR Hardware or remote control error detected
- FAST Fast reading rate
- FILT Digital filter enabled
- HOLD Reading HOLD is enabled
- MATH A math operation is enabled (mX+b, %, dB, dBm).
- MED Medium reading rate
- MEM Turns on when reading memory is enabled
- REL Relative reading displayed
- RMT Multimeter is in remote mode
- SHIFT Accessing shifted keys

SLOW Slow reading rate
 TRIG Multimeter is waiting for an external trigger (front panel or bus).

2.3 Front Panel Menu Reference

A: MEASurement MENU

1:CONTINUITY → 2:FILTER → 3:FILT TYPE → 4:FILT COUNT

1. CONTINUITY Select the continuity beeper threshold: 1 Ω to 1000 Ω .
2. FILTER Enable or disable FILTER function.
3. FILT TYPE Select the moving average or repeating average type of filter.
4. FILT COUNT Set the number of readings to be filtered or averaged.

B: MATH MENU

1:SET M → 2:SET B → 3:PERCENT → 4:dB REF → 5:dBm REF → 6:LIMIT TEST → 7:HIGH LIMIT
 → 8:LOW LIMITT → 9:LIMIT BEEP

1. SET M Set the scale factor M for MX+B function.
2. SET B Set the offset factor B for MX+B function.
3. PERCENT Set the reference value for PERCENT function.
4. dB REF Set the dB reference voltage value.
5. dBm REF Set the dBm reference impedance value.
6. LIMIT TEST Enable or disable the limit testing.
7. HIGH LIMIT Set the high limit for limit testing.
8. LOW LIMIT Set the low limit for limit testing.
9. LIMIT BEEP Set the beep mode for limit testing.

C: TRIGger MENU

1:READ HOLD → 2:READ COUNT → 3:TRIG MODE → 4:TRIG DELAY

1. READ HOLD Set the reading hold sensitivity band.
2. READ COUNT COUNT of readings for reading hold.
3. TRIG MODE Select INTernal, MANUal or BUS trigger source mode.
4. TRIG DELAY Select AUTO or MANUal trigger delay mode and specified a time interval which is inserted before a measurement for the MANUal trigger delay mode.

D: SYSTem MENU

1:RDGS STORE → 2:RDGS COUNT → 3:SAVED RDGS → 4:BEEP → 5:SAVE CNFG
 → 6:LOAD CNFG → 7:DISPLAY → 8:KEY SOUND → 9:TEST

1. RDGS STORE Enable or disable reading memory.
2. RDGS COUNT Set the number of readings to be saved (2 to 512).
3. SAVED RDGS Recall readings stored in memory.
4. BEEP Enable or disable the beeper function
5. SAVE CNFG Save the present configuration as one of the 10 user's settings.
6. LOAD CNFG Restore factory or one of the 10 user's settings
7. DISPLAY Enable or disable the front panel display.
8. KEY SOUND Enable or disable the key sound when you press a key.
9. TEST Perform a complete self-test.

E: Input / Output MENU

1:GPIB ADDR → 2:INTERFACE → 3:BAUD RATE→ 4:PARITY→ 5:TX TERM→ 6:RETURN

1. GPIB ADDR Set the GPIB bus address (0 to 31)
2. INTERFACE Select one between GPIB and USB as the remote control interface.
3. BAUD RATE Select the baud rate for RS232C(USB) operation.
4. PARITY Select the parity mode for RS232C(USB)
5. TX TERM Select the terminal character for RS232C(USB) communication
6. RETURN Enable or disable the command characters RETURN function.





F: CALibration MENU ^①

1:SECURED → [1:UNSECURED] → [2:CALIBRATE] → 3:CAL DATE → 4:CAL COUNT

1. SECURED The multimeter is secured against calibration; Enter code to unsecure.
2. UNSECURED The multimeter is unsecured for calibration; Enter code to secure.
3. CALIBRATE Perform complete calibration of present function when UNSECURED.
4. CAL DATE Read the date for the latest calibration.
5. CAL COUNT Read the total number of times the multimeter has been calibrated.

^①The commands enclosed in square brackets ([]) are "hidden" unless the multimeter is UNSECURED for calibration.

2.4 Front Panel Menu Overview

The menu is organized in a top-down tree structure with three levels (menus, commands and parameters) as shown in Figure 2-3. You can use down () or up () to move menu tree from one level to another. Each of the three levels has several horizontal choices which you can view by using left () or right ().

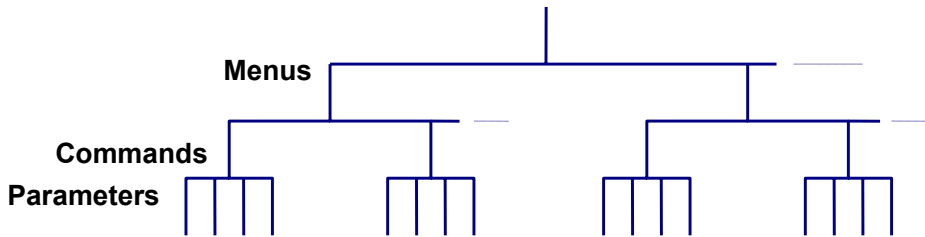













Figure 2-3 Menu Tree

- To turn on the menu, press  →  (Menu).
- To turn off the menu, press  →  (Menu), or press any of the function or math keys on the top row of front panel keys.
- To confirm a change on the “parameter” level, press  (ENTER).
- To cancel a change on the “parameter” level, press  (ESC).
- To recall the last menu command that was executed, press  →  (Recall)

The messages displayed during menu operation are listed in following Table 2-1.

Table 2-1 Messages Displayed During Menu Operation

MESSAGES	DESCRIPTION
CHANGE SAVED	The change made on the “parameter” level is saved. This message will be displayed after you press  (ENTER) to execute the command.
TOO SMALL	The value you specified on the “parameter” level is too small for the selected command. The minimum value allowed is displayed for you to edit.
TOO LARGE	The value you specified on the “parameter” level is too large for the selected command. The maximum value allowed is displayed for you to edit.
FILE SAVING	System configuration file is being saved.
FILE LOADING	System configuration file is being restored.
SAVE SUCCEED	System configuration file is successfully saved.
LOAD SUCCEED	System configuration file is successfully restored.

Note: If you press  on the “menu” level, this is the top level of the menu and you can not go any higher; similarly if you press  on the “parameter” level, this is the bottom level of the menu and you can not go any lower.

2.5 Rear Panel Summary

The rear panel of TH1951 is shown in Figure 2-4. This section includes important information that should be reviewed before operating the instrument.

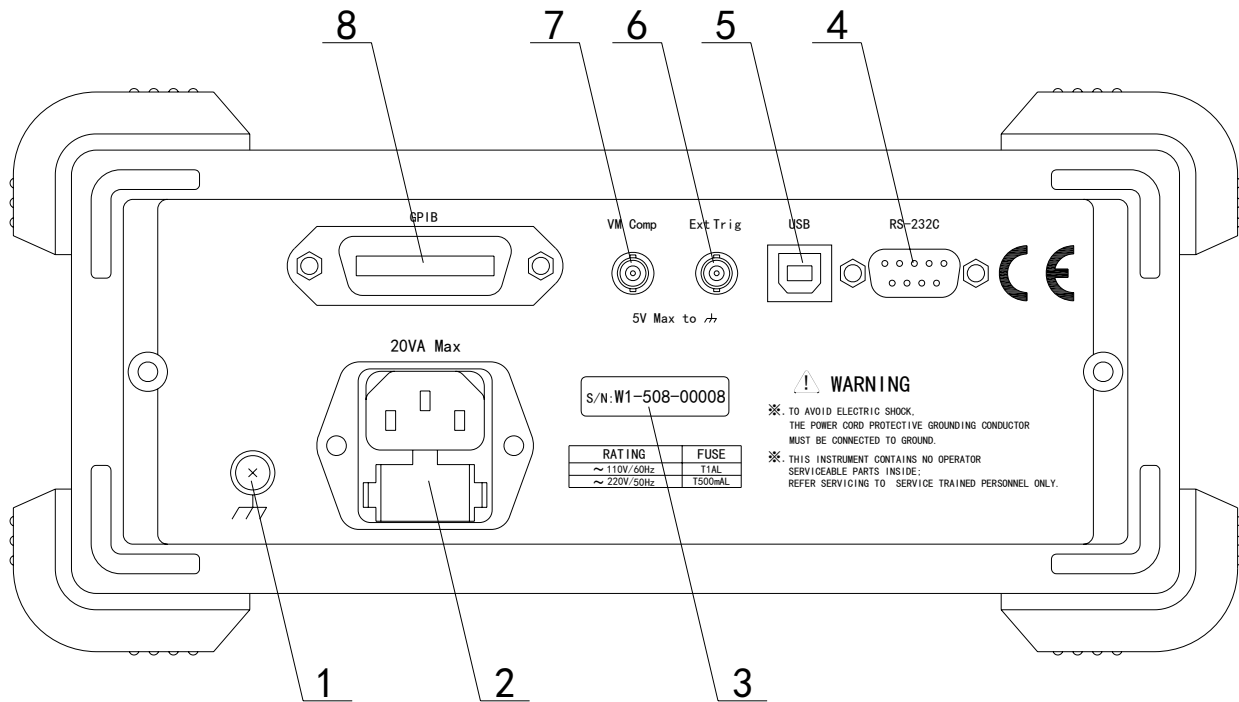

Figure 2-4 TH1951 Rear Panel

1. Grounding
Chassis Grounding terminal
2. Power-Line Fuse-Holder Assembly
TH1951 can be configured for line voltage of 110/220V±10% AC at line frequency of 50/60Hz±5%. Power-line fuse is used for instrument protection. (220V/500mA or 110V/1A)
Note: Please use the same-type fuse or contact your nearest Tonghui sales and service office.
To verify and replace the fuse, remove the power cable and pull out the fuse holder.
3. Label
Serial number for this instrument
4. RS-232C Connector
Connector for RS-232 operation. Use a standard DB-9 cable.
5. USB Connector
This USB device interface can be connect to a PC to replace the RS-232 operation.
6. Ext Trig
External trigger signal input terminal.
7. VM Comp
Voltmeter complete output terminal
8. GPIB(Optional)
Connector for GPIB (IEEE-488) operation. This is an optional interface; user needs additional order if it is required.

2.6 Power up

2.6.1 Power Line Connection

Follow the procedure below to connect the TH1951 to line power and turn on the instrument.

1. Check to make sure that the line voltage is in the range of 198V to 242V (or $110V \pm 10\%$) and line frequency is in the range of 47.5 to 52.5Hz (or $60Hz \pm 5\%$) before connecting the power cord.

CAUTION: *Operating the instrument on an incorrect voltage may cause damage to the instrument, possibly voiding the warranty.*

2. Before plugging in the power cord, make sure that the front panel power switch is in the off position.
3. Connect the female end of the supplied power cord to the AC receptacle on the rear panel. Connect the other end of the power cord to a grounded AC outlet.

WARNING: *The power cord supplied with the Model TH1951 contains a separate ground wire for use with grounded outlets. When proper connections are made, instrument chassis is connected to power line ground through the ground wire in the power cord. Failure to use a grounded outlet may result in personal injury or death due to electric shock.*

4. Turn on the instrument by pressing the front panel power switch and get ready for measuring.

2.6.2 Power-up Sequence

On power-up, Model TH1951 performs self-tests on its EPROM and RAM and lights all segments and annunciators for about 1 second. If a failure is detected, the instrument momentarily displays an error message and the ERR annunciator turns on.

If the instrument passes self-tests, the firmware revision levels are displayed.

2.6.3 High Energy Circuit Safety Precautions

To optimize safety when measuring voltage in high energy distribution circuits, read and use the directions in the following warning.

WARNIG: *Dangerous arcs of an explosive nature in a high energy circuit can cause severe personal injury or death .If the multimeter is connected to a high energy circuit when set to a current range, low resistance range, or any other low impedance range, the circuit is virtually shorted. Dangerous arcing can result even when the multimeter is set to a voltage range if the minimum voltage spacing is reduced in the external connections.*

When making measurements in high energy circuits, use test leads and accessories that meet the following requirements:

- Test leads and accessories must be fully insulated.
- Only use test leads that can be connected to the circuit (e.g., alligator clips, spade lugs, etc.) for

hands-off measurements.

- Do not use test leads or accessories that decrease voltage spacing. This diminishes arc protection and creates a hazardous condition.

Use the following sequence when measuring high energy circuits:

1. De-energize the circuit using the regular installed connect-disconnect device, such as a circuit breaker, main switch, etc.
2. Attach the test leads to the circuit under test. Use appropriate safety rated test leads for this application.
3. Set the multimeter to the proper measurement function and range.
4. Energize the circuit using the installed connect-disconnect device and make measurements without disconnecting the multimeter.
5. De-energize the circuit using the installed connect-disconnect device.
6. Disconnect the test leads from the circuit under test.

WARNING: The maximum common-mode voltage (voltage between INPUT LO and the chassis ground) is 500V peak. Exceeding this value may cause a breakdown in insulation, creating a shock hazard.

2.6.4 Power-on Defaults

Model TH1951 uses the factory default settings for the power-on settings.

Since the basic measurement procedures in this manual assume the factory defaults, reset the instrument to the factory settings when following step-by-step procedures. Table 2-2 lists the factory default settings.

Table 2-2 Factory Default Settings

Setting	Factory Default
Autozero	On
Buffer	No effect
Continuity	
Beeper	On
Digits	4 1/2
Rate	Fast(0.1 PLC)
Threshold	10Ω
Current(AC and DC)	
Digits(AC)	5 1/2
Digits(DC)	5 1/2
Filter	On
Count	5
Mode	Moving average
Range	Auto
Relative	Off
Value	0.0
Rate(AC)	Medium(10PLC)
Rate(DC)	Medium(1 PLC)
Diode test	
Digits	5 1/2
Range	1mA
Rate	Medium(1 PLC)
Frequency and Period	
Digits	5 1/2
Range	10V
Relative	Off
Value	0.0
Rate	Slow(1 sec)
Function	DCV
GPIB	No effect
Address	8
Language	SCPI
Limits	Off
Beeper	ON
High limit	+1
Low limit	-1
mX+b	Off
Scale factor	1.0
Offset	0.0
Percent	Off
Reference	1.0

Table 2-2 Factory Default Settings (cont.)

Resistance(2-wire and 4-wire)	
Digits	5 1/2
Filter	On
Count	5
Mode	Moving average
Range	Auto
Relative	Off
Value	0.0
Rate	Medium(1 PLC)
RS-232(USB)	On
Baud	9600
Triggers	
Continuous	On
Delay	Auto
Source	Immediate
Voltage(AC and DC)	
dB reference	No effect
dBm reference	75Ω
Digits(AC)	5 1/2
Digits(DC)	5 1/2
Filter	On
Count	5
Mode	Moving average
Range	Auto
Relative	Off
Value	0.0
Rate(AC)	Medium(10PLC)
Rate(DC)	Medium(1 PLC)

2.6.5 Warm-up time

Model TH1951 is ready for use as soon as the power-up sequence has completed. However, to achieve rated accuracy and stability, allow the instrument to warm up for half an hour. If the instrument has been subjected to extreme temperatures, allow additional time for internal temperatures to stabilize.



2.7 Display

The display of Model TH1951 is primarily used to display readings, along with the units and type of measurement. Annunciators located on the left, right and bottom indicate various states of operation. See section 2.2 for a complete listing of annunciators.

Chapter 3 Basic Measurements

3.1 Preparation

One of the first things you would like to do with your multimeter is to become acquainted with its front panel. We have provided some exercises in foregoing chapters about preparations for use and operations of front panel.

The front panel has two rows of keys to select various functions and operations. Most keys have a shifted function printed in blue above the key. To perform a shifted function, press  (the **Shift** annunciator will turn on). Then, press the key that has the desired label above it. For example, to select the AC current function, press  then press  (ACI) .

If you accidentally press , just press it again to turn off the **Shift** annunciator.

3.2 Measuring Voltage





Voltage ranges: 100 mV, 1 V, 10 V, 100 V, 1000 V (750 VAC)

Maximum resolution: 1 μ V (on 100mV range)



AC technique: true RMS, ac-coupled.

3.2.1 Connections

Assuming Model TH1951 is under factory default conditions, the basic procedure is as follows:

1. Connect test leads to INPUT HI and LO terminals.
2. Select DC or AC voltage measurement by pressing  or .
3. Press  toggles auto ranging. Notice the **AUTO** annunciator is displayed with auto ranging. If you want manual ranging, use the RANGE  and  keys to select a measurement range consistent with expected voltage.
4. Connect test leads to the sources as shown in Figure 3-1.

CAUTION: *Do not apply more than 1000V peak to the input or instrument damages may occur.*

5. If the “**OVR.FLW**” message is displayed, press the up  key to select a higher range until a normal reading is displayed (or press  key for auto ranging). Use the lowest possible range for the best resolution.
6. Take readings from the display.

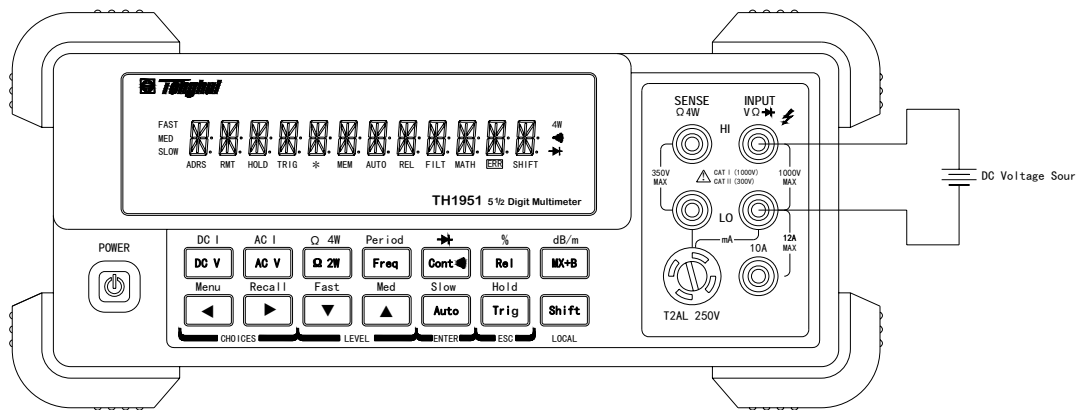

Input Resistance = 10MΩ on 1000V and 100V ranges;
 > 10GΩ on 10V, 1V and 100 mV ranges

CAUTION: Maximum Input = 1010V peak

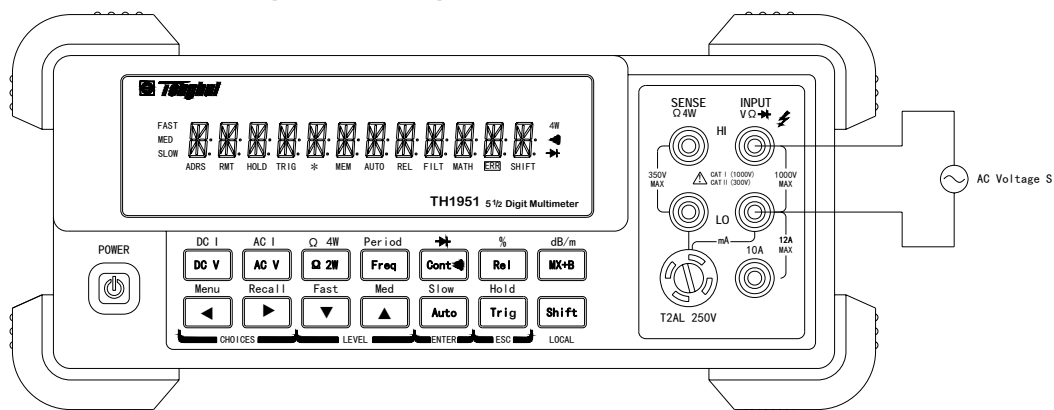

Input Impedance = 1MΩ and 100pF

CAUTION: Maximum Input = 750V RMS or 1000V peak, 3×10^7 V.Hz

Figure 3-1 DC and AC Voltage Measurement Connections

3.2.2 Crest factor

AC voltage and current accuracies are affected by the crest factor of the waveform, the ratio of the peak value to the RMS value. Table 3-1 lists the fundamental frequencies at which the corresponding crest factor must be taken into account for accuracy calculations.

Table 3-1 Crest Factor Limitations

Crest Factor	Fundamental Frequency
2	50kHz
3	3kHz
4-5	1kHz

3.3 Measuring Current

Model TH1951 current measurement range: 10 mA, 100 mA (DC only), 1A, 10A

Maximum resolution: 100nA (on 10 mA range)

Note: See the previous discussion about crest factor in Voltage Measurement in this section

3.3.1 Connections

Assuming Model TH1951 is under factory default conditions, the basic procedure is as follows:

1. Connect test leads to INPUT LO and SENSE LO terminals
2. Select DCI or ACI measurement function by pressing **Shift** → **DCV** or **Shift** → **ACV**
3. Press **Auto** toggles auto ranging. Notice the **AUTO** annunciator is displayed with auto ranging. If you want manual ranging, use the RANGE **▲** and **▼** keys to select a measurement range consistent with expected current.
4. Connect test leads to the source as shown in Figure 3-2:

CAUTION: Do not apply more than 2A between INPUT LO and SENSE LO terminals, or the protective fuse on the front panel will open-circuit.

5. If the “OVR.FLW” message is displayed, press up **▲** key to select a higher range until a normal reading is displayed (or press **Auto** key for auto ranging). Use the lowest possible range for the best resolution.
6. Take readings from the display.

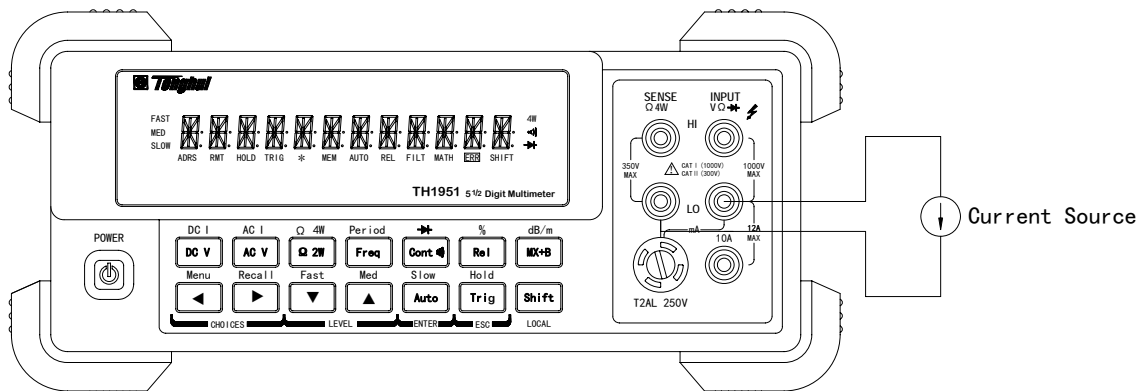

CAUTION: Maximum input = 1A DC or RMS

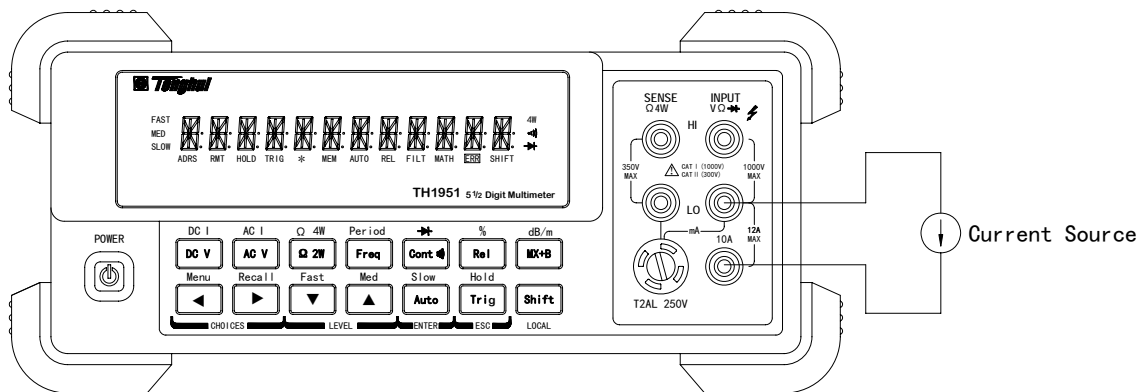

CAUTION: Maximum Input = 12A DC or RMS

Figure 3-2 DC and AC Current Measurements

3.3.2 Front Panel Fuse Replacement

WARNING: *Make sure the instrument is disconnected from the power line and other equipment before replacing the fuse.*

1. Turn off the power and disconnect the power line and test leads.
2. From the front panel, use a screwdriver to rotate the fuse carrier several turns counter-clockwise. Take the fuse carrier out of the socket.
3. Remove the fuse and replace it with the same type (T2AL, 250V, 5×20mm) .

CAUTION: *Do not use a fuse with a higher current rating than specified or instrument damage may occur. If the instrument repeatedly blows fuses, try to find out the reason before replacing the fuse.*

4. Install the new fuse by reversing the procedure above.

3.4 Measuring Resistance

Model TH1951 Resistance measurement range: 100Ω, 1kΩ, 10kΩ, 100kΩ, 1MΩ, 10MΩ, 100MΩ;
Maximum resolution: 1mΩ (on 100Ω range)

3.4.1 Connections

Assuming Model TH1951 is under factory default conditions, the basic procedure is as follows:

1. Connect test leads to the Model TH1951 as follows:
 - A: For Ω2-wire, connect the test leads to INPUT HI and LO.
 - B: For Ω4-wire, connect the test leads to INPUT HI and LO, and SENSE Ω 4W HI and LO. Kelvin test probes are recommended.
2. Select Ω 2-wire or Ω 4-wire measurement function by pressing $\Omega 2W$ or Shift → $\Omega 2W$.
3. Press Auto toggles auto ranging. Notice the **AUTO** annunciator is displayed with auto ranging. If you want manual ranging, use the RANGE \blacktriangle and \blacktriangledown keys to select a measurement range consistent with expected resistance.
4. Connect test leads to the resistance as shown in Figure 3-3:

CAUTION: *Do not apply more than 1000V peak between INPUT HI and LO or instrument damage may occur.*

5. If the “**OVR.FLW**” message is displayed, press up \blacktriangle key to select a higher range until a normal reading is displayed (or press Auto key for auto ranging). Use the lowest possible range for the best resolution.
6. Take readings from the display.

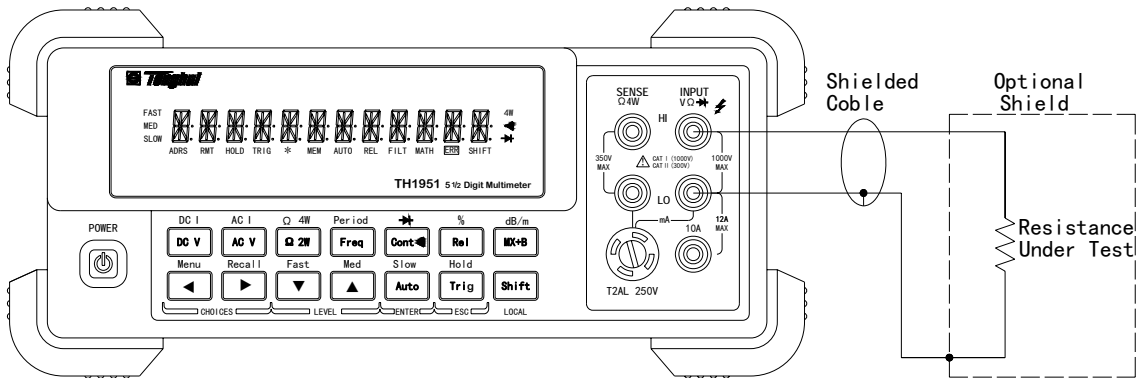

Note: Source current flows from the INPUT HI to INPUT LO terminals

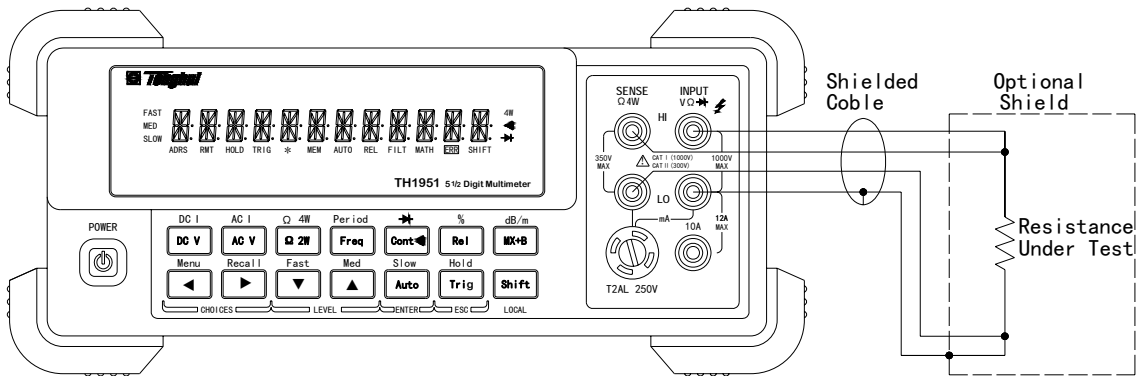

Note: Source current flows from the INPUT HI to INPUT LO terminals

Figure 3-3 Two- and Four- wire Resistance Measurements

3.4.2 Shielding



To achieve a stable reading, it helps to shield resistances greater than 100kΩ. Place the resistance in a shielded enclosure and connect the shield to the INPUT LO terminal of the instrument electrically.

3.5 Measuring Frequency and Period

Model TH1951 frequency measurement range: 5 Hz to more than 1MHz.

Model TH1951 period measurement range: 0.2s to less than 1μs.

Input signal range: 100 mV AC to 750V AC RMS.

The instrument uses the volts input terminals to measure frequency. The AC voltage range can be changed with the RANGE  and  keys. However, the signal voltage must be greater than 10% of the full-scale range.

3.5.1 Trigger Level and Measurement Errors

Frequency and Period apply a zero-crossing trigger, meaning that a count is taken when the signal crosses the zero level.

Model TH1951 uses an interactive counting technique to measure frequency and period. This method generates constant measurement resolution for any input frequency. All frequency counters are subject to errors when measuring low-voltage, low-frequency signals. Both internal noise and external noise are also critical when measuring low-voltage, low frequency signals. Measurement errors will also occur if you attempt to measure the frequency (or period) of an input following a dc offset voltage change. You must allow the multimeter's DC input blocking capacitor to fully settle before making frequency measurements.

3.5.2 Gate Time

Gate time is the amount of time Model TH1951 uses to sample frequency or period readings. All settings of the RATE function (Fast, Med and Slow) yield a gate time of one second.

3.5.3 Connections

Assuming Model TH1951 is under factory default conditions, the basic procedure is as follows:

1. Connect test leads to INPUT HI and LO terminals.
2. Select frequency or period measurement functions by pressing **Freq** or **Shift** → **Freq**
3. Connect test leads to the source as shown in Figure 3-4:

CAUTION: Do not exceed 1000V peak between INPUT HI and INPUT LO or instrument damage may occur.

4. Taking a reading from the display

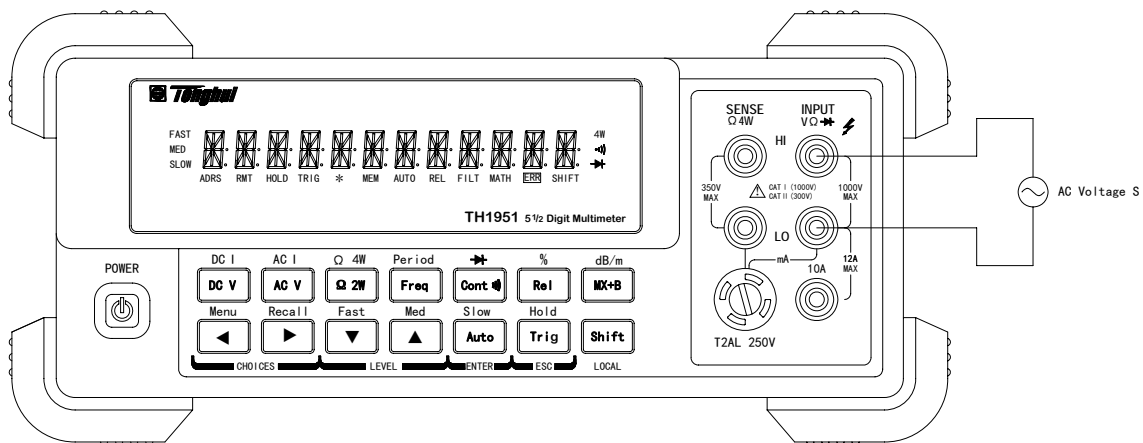

Input Impedance = 1MΩ in parallel with <100pF

CAUTION: Maximum Input = 750 RMS, or 1000V Peak

Figure 3-4 Frequency and Period Measurements

3.6 Measuring Continuity

Model Th1951 uses the 1k Ω range to measure circuit continuity. A threshold resistance level (1 Ω to 1000 Ω) should be set and factory default value is 10 Ω . Multimeter alerts you with a beep when a reading is below the set level.

Note: Continuity has a non-selectable reading rate of FAST (0.1 PLC).

3.6.1 Connections

Assuming Model TH1951 is under factory default conditions, the basic procedure is as follows:

1. Connect test leads to the INPUT HI and LO terminals.
2. Select Continuity measurement function by pressing **Cont**.
3. Connect test leads to the resistance under test as shown in Figure 3-5.
4. Take a reading from the display

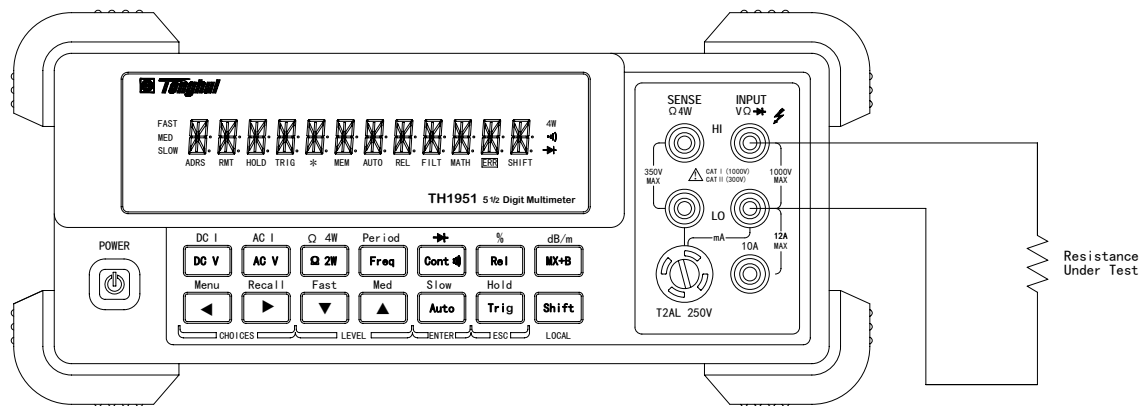

Note: Source current flows from the INPUT HI to INPUT LO terminals.

Figure 3-5 Continuity Measurement

3.6.2 Threshold resistance level

You can define a threshold resistance from 1 Ω to 1000 Ω . Factory default value is 10 Ω . Follow the steps below to define the resistance level:

1. Press **Cont** for Continuity Measurement.
2. Press **Shift** \rightarrow **▶** to enter the command level, "1: CONTINUITY" will be displayed.
3. Press **▼** to enter the parameter level, the current LEVEL value will be displayed.
4. Use **◀** and **▶** keys to choose a numerical place and use **▲** and **▼** keys to increment or decrement the digits. Enter a value from 1 to 1000.
5. Press **Auto** (ENTER) to confirm your setting. Message "CHANGE SAVED" will be displayed for a moment.
6. Press **Cont** or **Shift** \rightarrow **◀** to exit the menu and return to the continuity measurement.

3.7 Testing Diode

Model TH1951 can also be used to measure the forward voltage drop of general-purpose diodes and the zener voltage of zener diodes. A current range (10mA, 100 μ A or 10 μ A) can be selected for diode measurement.

Note: *Diode test has a non-selectable reading rate of Medium (1 PLC)*

3.7.1 Connections

Assuming Model TH1951 is under factory default conditions, the basic procedure is as follows:

1. Connect test leads to INPUT HI and LO terminals.
2. Press **Shift** → **Cont** for diode measurement function.
3. Connect test leads to the diode under test as shown in Figure 3-6.
4. Take a reading from the display.

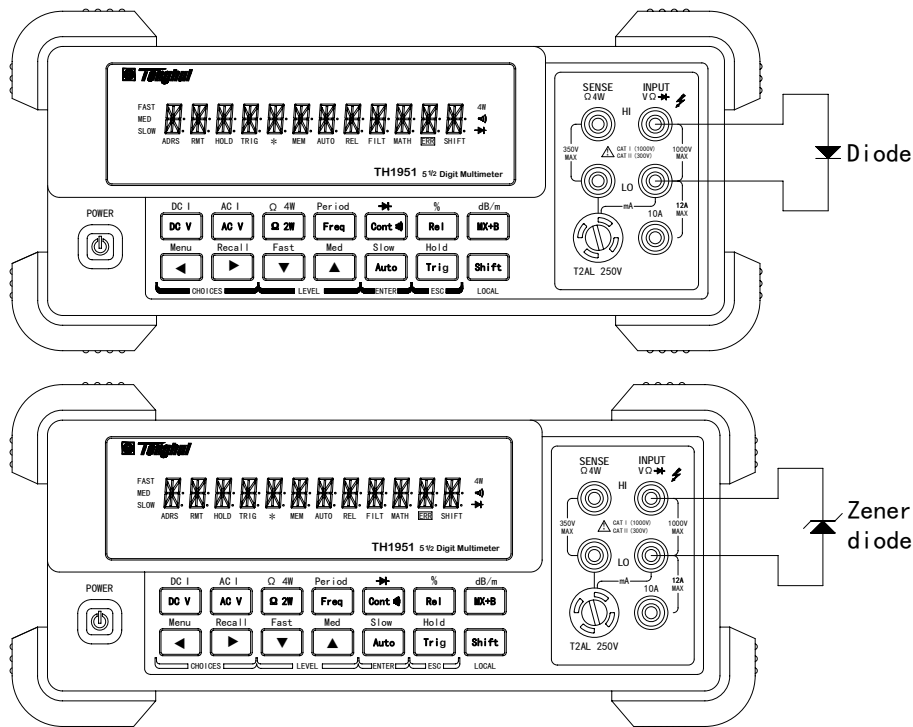

Note: *Source current flows from the INPUT HI to INPUT LO terminals*

Figure 3-6 Diode Measurement

3.7.2 Current Range

You can set the test current range from the front panel. The choices are 1mA, 100 μ A, and 10 μ A. The factory default current range is 1mA. To set the test current as follows:

1. Press **Shift** → **Cont** for diode measurement function
2. Using **▲** and **▼** keys to scroll through the three test current selections.

The diode test function measures voltage on the 3V range for the 1mA test current and the 10V range for the 100 μ A and 10 μ A ranges. If a reading is more than 10V, Model TH1951 displays the “OVR.FLW” message.

3.8 Math Functions

Model Th1951 math operations are divided into four categories:

- $mX+b$ and percent
- dB and dBm calculations
- Statistics of buffered readings
- Limit testing

The first two categories are discussed here; buffered reading statistics and reading limit testing are described in the next chapter – Measurement Options

Notes: *Once enabled for a function, the $mX+b$ and percentage calculations are in effect across function changes.*

3.8.1 $mX+b$

This math operation lets you manipulate normal display readings (X) mathematically according to the following calculation:

$$Y = mX + b$$

Where: X is the normal display reading

m and b are user-entered constants for scale factor and offset











Y is the displayed result

To configure the $mX+b$ calculation, perform the following steps:

1. Press **mX+b** for $mX+b$ math operation and the present scale factor M will be displayed:
M: +1.00000λ
2. Use the **◀** and **▶** keys to choose a numerical place and use **▲** and **▼** keys to increment or decrement the digits. Enter a value and units prefix.
3. Press **Auto**(ENTER) to confirm the M value and the message “**CHANGE SAVED**” will be displayed for a moment and then the present B value will be displayed.
B: +0.00000 m
4. Enter a value and units prefix.
5. Press **Auto**(ENTER) to confirm the B value, “**CHANGE SAVED**” will be displayed.
6. TH1951 returns back to the measurement status and displays the results of calculations.

If you want to change the M and B parameter values after enabling the math function, besides the foregoing method you can take actions as below:

1. Press **Shift** → **▶**, “**1: SET M**” will be displayed (Command level).
2. Press **▼** key to enter the parameter level and the present scale factor M will be displayed:
M: +1.00000λ
3. Use the **◀** and **▶** keys to choose a numerical place and use **▲** and **▼** keys to increment or decrement the digits. Enter a value and units prefix.
4. Press **Auto**(ENTER) to confirm the M value and the message “**CHANGE SAVED**” will be displayed for a moment and then TH1951 returns back to the command level. Press **Trig**(ESC) to cancel the M value input, TH1951 returns back to the command level without changing the M value.

5. Press , "2: SET B" will be displayed (Command level).
6. Press  key to enter the parameter level and the present offset factor B will be displayed:
B: +00.0000 m.
7. Use the  and  keys to choose a numerical place and use  and  keys to increment or decrement the digits. Enter a value and units prefix.
8. Press  (ENTER) to confirm the B value. The message "CHANGE SAVED" will be displayed for a moment and then TH1951 returns back to the command level. Press  (ESC) to cancel the B value input, TH1951 returns back to the command level without changing the B value.
9. Press  →  to exit the menu operation, and return back to the mX+b math operation status.







3.8.2 Percent

If the percent calculation is selected, a reference value must be specified. The displayed reading will be expressed as percent deviation from the reference value. The percentage calculation is performed as follows:











$$\text{Percent} = \frac{\text{Input} - \text{Reference}}{\text{Reference}} \times 100\%$$

Where: Input is the normal display reading
Reference is the user-entered constant
Percent is the displayed result

To configure the percent calculation, perform the following steps:

1. Press  →  for percent math operation and the present reference value displays:
REF: +1.00000Λ
2. Use  and  keys to choose a numerical place and use  and  keys to increment or decrement the digits. Enter a value and units prefix.
3. Press  (ENTER) to confirm the reference value. The message "CHANGE SAVED" will be displayed for a moment.
4. TH1951 will display the result of the percent calculation.

If you want to change the parameter values when the percent math function is enabled, besides the foregoing method you can take actions as below:

1. Press  →  to enter the command level, "3: PERCENT" will be displayed.
2. Press  to enter the parameter level, and the present reference value will be displayed:
REF: +1.00000Λ.
3. Use  and  keys to choose a numerical place and use  and  keys to increment or decrement the digits. Enter a value and units prefix.
4. Press  (ENTER) to confirm the reference value, "CHANGE SAVED" will be displayed for a moment, and TH1951 will return to the command level. Press  (ESC) to cancel the reference value input, TH1951 returns back to the command level without changing the reference value.
5. Press  →  key to exit the menu and return to the percent math operation status.

Model TH1951 will display measurement result of calculation. If the value of "Input" is larger than that of "Reference", displayed result will be positive; contrarily, it will be negative if the value of "Input" is smaller than that of "Reference".

3.8.3 dB Calculation

Expressing DC and AC voltage in dB makes it possible to compress a large range of measurements into a much smaller scope. The relationship between dB and voltage is defined by the following equation:

$$\text{dB} = 20 \log \frac{V_{IN}}{V_{REF}}$$

Where: V_{IN} is the DC or AC input signal

V_{REF} is the specified voltage reference level

The instrument will read 0dB when the reference voltage level is applied to the input.

If a relative value is in effect when dB is selected, this relative value will be converted to dB value before REL is applied. If REL is applied after dB function has been selected, dB has REL applied to it directly.

To set the reference voltage, perform the following steps:

1. Press **Shift** + **mX+b** for dB math operation and the present reference value is displayed:
REF: +0.00000
2. Use **◀** and **▶** keys to choose a numerical place and use **▲** and **▼** keys to increment or decrement the digits. Enter a value and units prefix.
3. Press **Auto**(ENTER) to confirm the reference voltage, the message “**CHANGE SAVED**” will be displayed for a moment. TH1951 returns back to the measurement status.
4. TH1951 will display the result of the dB calculation.

If you want to change the parameter values when dB function is in effect, you can take actions as below:

1. Press **Shift** → **▶** to enter the command level, “**4: dB REF** “ will be displayed.
2. Press **▼** to enter the parameter level, and the present reference value will be displayed:
REF: +1.00000Λ.
3. Use **◀** and **▶** keys to choose a numerical place and use **▲** and **▼** keys to increment or decrement the digits. Enter a value and units prefix.
4. Press **Auto**(ENTER) to confirm the reference value, the message “**CHANGE SAVED**” will be displayed for a moment, and TH1951 will return to the command level. Press **Trig**(ESC) to cancel the reference value input, TH1951 returns back to the command level without changing the reference value.
5. Press **Shift** → **◀** key to exit the menu and return to the dB math operation status.

Notes: *The dB calculation takes the absolute value of the ratio V_{IN}/V_{REF} . The largest negative value of dB is -160dB. This will accommodate a ratio of $V_{IN} = 1\mu V$, $V_{REF} = 1000V$.*

3.8.4 dBm Calculation

dBm is defined as decibels above or below a 1mW reference. With an user-programmable reference impedance, Model TH1951 reads 0dBm when the voltage needed to dissipate 1mW through the reference impedance is applied. The relationship between dBm, reference impedance, and the voltage is defined by the following equation:

$$\text{dBm} = 10 \log \frac{(V_{\text{IN}}^2 / Z_{\text{REF}})}{1\text{mW}}$$

Where: V_{IN} is the DC or AC input signal voltage value.
 Z_{REF} is the specified reference impedance.

If a relative value is in effect when dBm is selected, the relative value will be converted to dBm value before REL is applied. If REL is applied after dBm has been selected, dBm has REL applied to it directly.

To set the reference impedance, perform the following steps:

1. Press **Shift** → **mX+b**, the voltage reference value for dB math function will be displayed.
2. Press **Auto** (ENTER) to confirm the voltage reference value, now you have selected the dB math function.
3. Press **Shift** → **mX+b** again, the present impedance reference value for dBm math function will be displayed:
REF: 0000
4. Use **◀** and **▶** keys to choose a numerical place and use **▲** and **▼** keys to increment or decrement the digits. Enter a value from 1Ω to 9999Ω.
5. Press **Auto** (ENTER) to confirm the reference impedance, the message “**CHANGE SAVED**” will be displayed for a moment. TH1951 returns back to the measurement status.
6. TH1951 will display the result of the dBm calculation.

If you want to change the impedance reference value after the dBm function is enabled, you can take actions as below:

1. Press **Shift** → **▶** to enter the command level, “**5: dBm REF** “ will be displayed.
2. Press **▼** to enter the parameter level, and the present impedance reference value will be displayed:
REF: 0000.
3. Use **◀** and **▶** keys to choose a numerical place and use **▲** and **▼** keys to increment or decrement the digits. Enter a value from 1Ω to 9999Ω.
4. Press **Auto** (ENTER) to confirm the reference value, the message “**CHANGE SAVED**” will be displayed for a moment, and TH1951 will return to the command level. Press **Trig** (ESC) to cancel the reference value input, TH1951 returns back to the command level without changing the reference value.
5. Press **Shift** → **◀** key to exit the menu and return to the dB math operation status.

NOTES: *The reference impedance and input impedance mentioned in this chapter are totally different. Input impedance is inherent in the instrument and could not be changed via foregoing methods.*

dBm is valid for both positive and negative DC voltage.

The mX+b and percent math operations are applied after the dBm or dB math. For example, if mX+b is selected with m=10 and b=0, the display will read 10.000MXB for a 1VDC signal. If dBm is selected with ($Z_{\text{REF}} = 50\Omega$), the display will read 130MXB.

Chapter 4 Measurement Options

This chapter provides description of the front panel features of TH1951. For those measurement options accessible only by a remote interface, refer to Chapter 5 and 6. This chapter is organized as follows:

- **Measurement Configuration** – Describes Ranging, Filtering, Relative readings, Digits of Resolution and Measurement rate
- **Triggering operations** – Explains trigger sources and trigger delay
- **Buffer operations** – Discusses the reading storage buffer and buffer statistics
- **Limit operations** – Defines how to set reading limits
- **System Operations** – Provides details on setup saving and restoring, instrument self-test and calibration

4.1 Measurement configuration

The following paragraphs discuss configuring multimeter for making measurement.



4.1.1 Range

You can let the multimeter automatically select the range using auto ranging or you can select a fixed range using manual ranging. Auto ranging is convenient because the multimeter automatically selects the appropriate range for each measurement. However, you can use manual ranging for faster measurements since the multimeter doesn't have to determine which range to use for each measurement. The multimeter returns back to auto ranging when power has been off or after a remote interface reset.

Maximum readings

The full scale readings for every range on each function are 20% over range except for the 1000VDC, 750VAC and diode test ranges.

Manual ranging

To select a range, simply press  or  key. The instrument changes one range per key press. The selected range is displayed for a moment.

If the instrument displays the “**OVR.FLW**” message on a particular range, select a higher range until an on-range reading is displayed. Use the lowest range possible without causing an overflow to ensure best accuracy and resolution.

Autoranging

To enable autoranging, press  key. The **AUTO** annunciator turns on when autoranging is selected. While autoranging is selected, the instrument automatically chooses the best range to measure the applied signal. However, autoranging should not be used when optimum speed is required.

Note that up-ranging occurs at 120% of the range, while down-ranging occurs at 10% of normal range.

To cancel autoranging, press **Auto** or **▲** or **▼** key. Pressing **Auto** to cancel autoranging leaves the instrument on the present range.

The **Auto** key has no effect on the continuity and diode test functions.

4.1.2 Filter

FILTER lets you set the filter response to stabilize noisy measurements. Model Th1951 uses a digital filter. The displayed, stored and transmitted readings are simply an average of a number of reading conversions (from 1 to 100).

Perform the following steps to select a filter:

1. Press **Shift** → **◀** to enter the menu on the menu level, "**A: MEAS MENU**" will be displayed.
2. Press **▼** to move down to the command level within the MESA MENU, "**1: CONTINUITY**" will be displayed.
3. Use **◀** or **▶** key to move across to the Filter Command on the command level, "**2: FILTER**" will be displayed.
4. Press **▼** to move down a level to the filter parameter choice.
5. Using **◀** or **▶** to select ON or OFF choice.
6. Press **Auto**(ENTER) to confirm the choice. The message "**CHANGE SAVED**" will be displayed to show that the change is now in effect. TH1951 automatically exits the parameter level and moves up a level to the command level.
7. Use **▶** to move across to the filter type command on the command level, "**3: FILT TYPE**" will be displayed.
8. Press **▼** to move down a level to the filter type parameter choice.
9. Using **◀** or **▶** to select MOVNG AV or REPEAT filter type.
10. Press **Auto**(ENTER) to confirm the choice. The message "**CHANGE SAVED**" will be displayed to show that the change is now in effect. TH1951 automatically exits the parameter level and moves up a level to the command level.
11. Use **▶** to move across to the filter count command on the command level, "**4: FILT COUNT**" will be displayed.
12. Press **▼** to move down a level to edit the filter count parameter.
13. Use **◀** and **▶** keys to choose a numerical place and use **▲** and **▼** keys to increment or decrement the digits. Enter a filter count from 1 to 100.
14. Press **Auto**(ENTER) to confirm the count value. The message "**CHANGE SAVED**" will be displayed to show that the change is now in effect. TH1951 automatically exits the parameter level and moves up a level to the command level.
15. Press **Shift** → **◀** key to exit from the menu and return to the measurement status.
16. The **FILT** annunciator turns on when the filter function enabled.

NOTE: *The filter can be set for any measurement function except frequency, period, continuity and diode test.*

Filter Types

A: Moving Average

The Moving average filter uses a first-in, first-out stack. When the stack becomes full, the measurement conversions are averaged, yielding a reading. For each subsequent conversion placed into the stack, the oldest conversion is discarded, and the stack is re-averaged, yielding a new reading. Shown in Figure 4-1.

B: Repeat average

For the repeating filter, the stack is filled and the conversions are averaged to yield a reading. The stack is then cleared and the process starts over as shown in Figure 4-1.

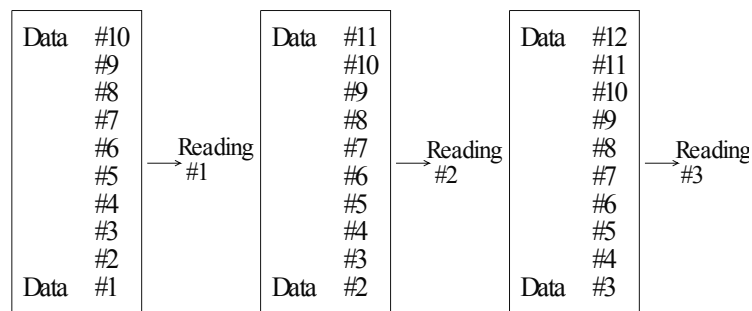

A. Type-Moving average, Filter Count=10

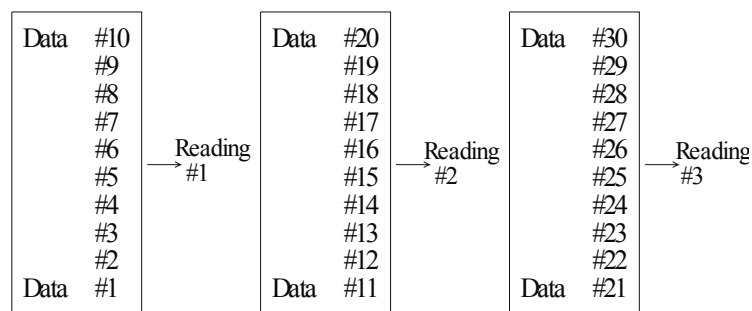

B. Type- Repeat average, Filter Count=10

Figure 4-1 Moving average and repeating average filters

Response Time

The filter parameters have speed and accuracy tradeoffs for the time needed to display, store, or output a filtered reading. These affect the number of reading conversions for speed versus accuracy and responder to input signal change.

4.1.3 Relative

The relative operation could be used to null offsets or subtract a baseline reading from present and future readings. When relative function is enabled, Model TH1951 uses the present reading as a relative value. Subsequent readings will be the difference between the actual input value and the relative value.

You can define a relative value for each function. Once a relative value is set for a measurement function,

the value is the same for all ranges. For example, if 2V is set as a relative value on the 10V range, the relative is also 2V on the 1000V, 100V, 1V or 100mV ranges.

Additionally, when you perform a zero correction for DCV, Ω2 or Ω4 measurements by enabling REL, the displayed offset becomes the reference value. Subtracting the offset from the actual input zeroes the display, as follows:

$$\text{Displayed reading} = \text{Actual Input} - \text{Reference}$$

Select a range that cannot accommodate the relative value does not cause an overflow condition, but it also does not increase the maximum allowable input for that range. For example: on the 1V range, Model TH1951 still overflows for a 1.2V input.

To set a REL value, press when the display shows the value you want as the relative value. The REL annunciator turns on. Press a second time to disable REL.

You can also input a REL value manually using the mX+b function. Set M for 1 and B for any value you want. Please refer to Chapter 3 for details about mX+b function.

4.1.4 Rate

The RATE operation sets the integration time of the A/D converter, the period of time the input signal is measured. The integration time affects the usable digits, the amount of reading noise, as well as the ultimate rading rate of the instrument. The integration time is specified in parameters based on a number of power line cycles (NPLC), where 1 PLC for 50Hz is 20msec.

In general, the fastest integration time (FAST (0.1 PLC) set from the front panel or remote interface) results in increased reading noise and fewer usable digits, while the slowest integration time (10 PLC) provides the best common-mode and normal-mode rejection. In-between settings are a compromise between speed and noise.

The RATE parameters are explained as follows:

Fast

FAST sets integration time to 0.1 PLC. Use FAST if speed is of primary importance, however it is at the expense of increased reading noise and fewer usable digits.

Medium

Medium sets integration time to 1 PLC. Use Medium when a compromise between noise performance and speed is acceptable.

Slow

Slow sets integration time to 10 PLC. SLOW provides better noise performance at the expense of speed.

For the AC functions (ACV, ACI), Rate setting determines the bandwidth setting as below:

- **Fast** 500Hz~100kHz.
- **Medium** 50Hz~100kHz.
- **Slow** 5Hz~100kHz.

Note: *The integration time can be set for any measurement function except frequency, period, continuity (FAST) and diode test (MEDIUM). For frequency and period, this value is gate time of 1sec.*

4.2 Trigger Operations

The multimeter's triggering system allows you to generate triggers either manually or automatically or externally and take multiple readings per trigger. The following paragraphs discuss front panel triggering, the programmable trigger delay and the reading hold feature.

4.2.1 Trigger model

The flowchart of Figure 4-2 summarizes triggering process of the instrument. It is called a trigger model because it is modeled after the SCPI commands used to control triggering.

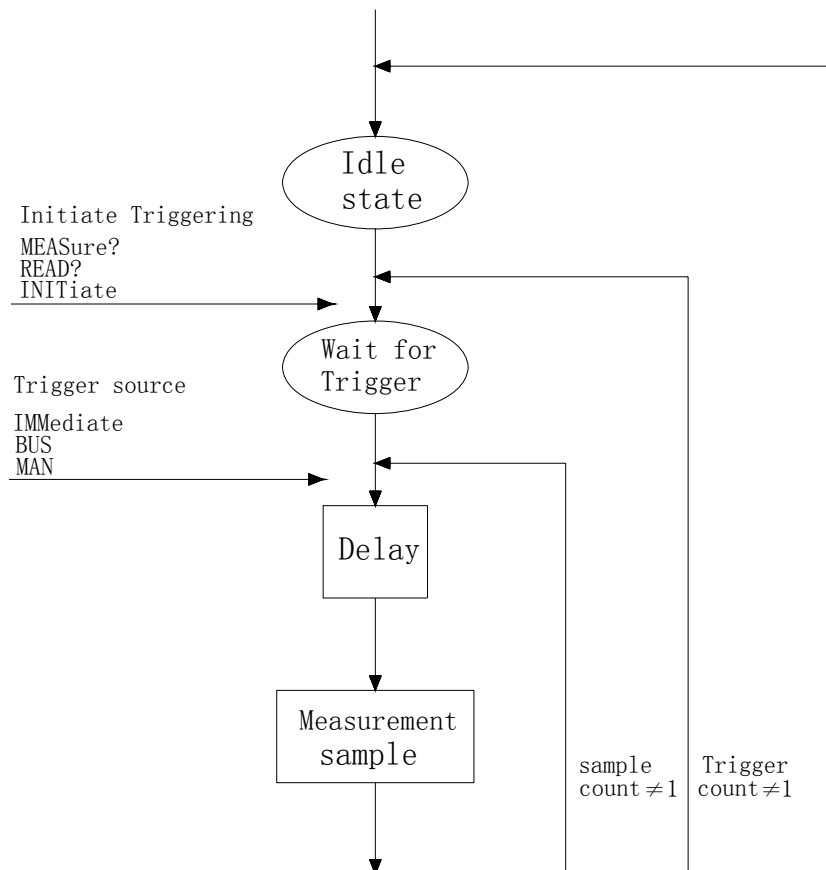

Figure 4-2 Trigger model

Idle

The instrument is considered to be in the idle state whenever it is not performing any measurement. Once Model TH1951 is taken out of idle, operation proceeds through the flowchart.

Wait for Trigger

The control source holds up operation until the programmable event occurs and is detected. See



description below for trigger sources:

- Immediate

With this trigger source, event detection is immediately satisfied allowing operation to continue.

- External

Event detection is satisfied for both kinds of triggers as below:

1. A bus trigger (*TRG) command is received.
2. The front panel  key is pressed (TH1951 must be taken out of remote before it will respond to  key).











Delay

A programmable delay is available after event detection. It can be set manually or automatically. With Auto delay, Model TH1951 selects a delay based on the function and range. The AUTO delay settings are listed in Table 4-1.













Table 4-1 Auto delay settings

Function	Range and Delay						
	100mV 1ms	1V 1ms	10V 1ms	100V 5ms	1000V 5ms		
DCV	100mV 1ms	1V 1ms	10V 1ms	100V 5ms	1000V 5ms		
ACV	100mV 400ms	1V 400ms	10V 400ms	100V 400ms	750V 400ms		
FREQ	100mV 1ms	1V 1ms	10V 1ms	100V 1ms	750V 1ms		
DCI	10mA 2ms	100mA 2ms	1A 2ms	10A 2ms			
ACI	10mA 400ms		1A 400ms	10A 400ms			
Ω2W, Ω4W	100Ω 3ms	1kΩ 3ms	10kΩ 13ms	100kΩ 25ms	1MΩ 100ms	10MΩ 150ms	100MΩ 250ms
Continuity		1kΩ 3ms					
Diode testing		1mA 1ms	100uA 1ms	10uA 1ms			

Take steps below for delay settings:

1. Press  →  to enter the menu on the menu level, “**A: MEAS MENU**” will be displayed.
2. Use  or  key to move across to the TRIG MENU on the menu level, “**C: TRIG MENU**” will be displayed.
3. Press  to move down to the command level within the TRIG MENU, “**1: READ HOLD**” will be displayed.
4. Use  or  key to move across to the TRIG MODE command on the command level, “**3: TRIG MODE**” will be displayed.
5. Press  to move down a level to select a trigger source.
6. Using  or  to select IMM, MAN or BUS trigger source.
7. Press  (ENTER) to confirm the choice. The message “**CHANGE SAVED**” will be displayed to show that the change is now in effect. TH1951 automatically exits the parameter level and moves up

a level to the command level.

8. Use  to move across to the TRIG DELAY command on the command level, “4: TRIG DELAY” will be displayed.
9. Press  to move down a level to set the type of delay mode.
10. Using  or  to select AUTO or MANU delay mode.
11. Press  (ENTER) to confirm the choice. The message “CHANGE SAVED” will be displayed to show that the change is now in effect. If AUTO mode is chosen, TH1951 will exit the parameter level and move up a level to the command level.
12. If MANU mode is chosen, TH1951 requires you to continue to specify the delay time. The present delay time will be displayed.
DELAY: 0000mS
13. Use  and  keys to choose a numerical place and use  and  keys to increment or decrement the digits. Enter a value of delay time (from 0 to 6000ms).
14. Press  (ENTER) to confirm the choice. The message “CHANGE SAVED” will be displayed to show that the change is now in effect. TH1951 automatically exits the parameter level and moves up a level to the command level.
15. Press  →  key to exit from the menu and return to the measurement status.

Note: *Changing the delay to MANUAL on one function changes the delays on all functions to MANUAL.*

Measurement Sample

The primary device action is a measurement. However, the device action block could include the following additional actions:





Filtering — If the repeating filter is enabled, the instrument samples the specified number of reading conversions to yield a single filtered reading. Only one reading conversion is performed if the filter is disabled, or after the specified number of reading conversions for a moving average filter is reached. The output of filter feeds hold function.

















Hold — With hold enabled, the first processed reading becomes the “Seed” reading and operation loops back within the measurement sample block. After the next reading is processed, it is checked to see if it is within the selected window (0.01%, 0.1%, 1%, 10%) of the “seed” reading. If the reading is within the window, operation again loops back within the measurement sample block. This looping continues until the specified number (2 – 100) consecutive readings are within the window. If one of the readings is not within the window, the instrument acquires a new “seed” reading and the hold process continues.

4.2.2 Reading Hold

When a hold reading is acquired as described in “Measurement Sample”, an audible beep is sounded (if enabled) and the reading is considered a “true measurement”. The reading is held on the display until an “out of window” reading occurs to restart the hold process. The reading hold feature allows you to capture and hold a stable reading on the display.

Take steps below to enable and set reading hold function.

1. Press  +  to enable reading hold function
2. Press  →  to enter the menu on the menu level, “A: MEAS MENU” will be displayed.

3. Use  or  key to move across to the TRIG MENU on the menu level, “C: TRIG MENU” will be displayed.
4. Press  to move down to the command level within the TRIG MENU, “1: READ HOLD” will be displayed.
5. Press  to move down a level to select a window percentage.
6. Use  or  key to select a window percentage (0.01%, 0.1%, 1%, 10%).
7. Press  (ENTER) to confirm the selection. The message “CHANGE SAVED” will be displayed to show that the change is now in effect. TH1951 automatically exits the parameter level and moves up a level to the command level.
8. Use  to move across to the READ COUNT command on the command level, “2: READ COUNT” will be displayed.
9. Press  to move down a level to enter a count value. (Default count is 5)
10. Use  and  keys to choose a numerical place and use  and  keys to increment or decrement the digits. Enter a value of count (from 2 to 100).
11. Press  (ENTER) to confirm the count. The message “CHANGE SAVED” will be displayed to show that the change is now in effect. TH1951 will exit the parameter level and move up a level to the command level.
12. Press  →  key to exit from the menu and return to the measurement status.

4.2.3 EXT Trig & VM Comp

Input a negative effective pulse to trigger the instrument through the Ext Trig input terminal, when the trigger mode is set to EXT as shown in Figure 4-3 below.

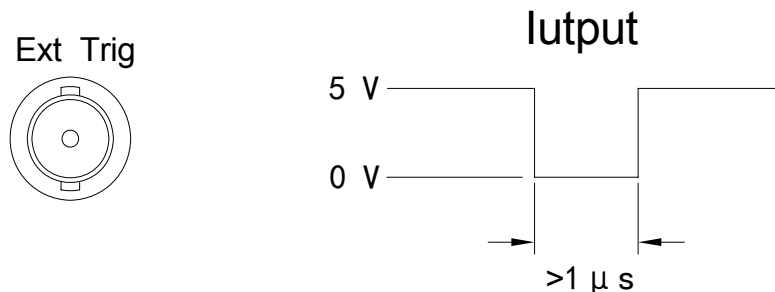

Figure 4-3 Trigger model

When the instrument finishes its present measurement, a Voltmeter Complete output signal will be outputted as shown in Figure 4-4 below.

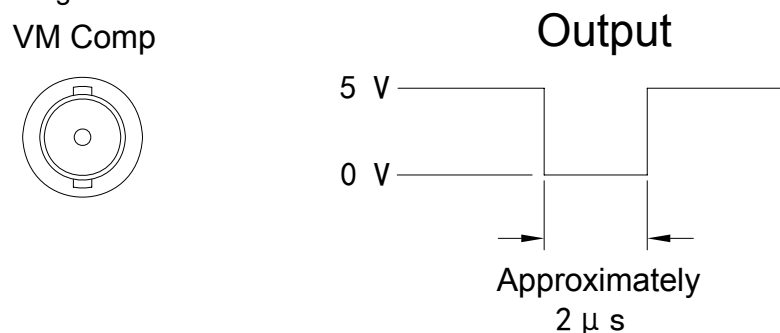

Figure 4-4 Trigger model

4.3 Buffer Operations

Model TH1951 has a buffer to store from 2 to 512 readings and units. In addition, recalled data includes statistical information, such as minimum, maximum, average and standard deviation.

The buffer fills with the requested number of readings and stops. Readings are placed in the buffer after any math operations are performed. Buffered data is overwritten each time the storage operation is selected. The data is volatile; it is not saved through a power cycle.

The following paragraphs will discuss storing and recalling buffered data.

4.3.1 Storing Reading







Select a measurement function and connect the test leads to the signal under test first. Then use the following procedure to store readings:

1. Set up the instrument for the desired configuration
2. Press **Shift** → **Left Arrow** to enter the menu on the menu level, "**A: MEAS MENU**" will be displayed.
3. Use **Left Arrow** or **Right Arrow** key to move across to the SYS MENU on the menu level, "**D: SYS MENU**" will be displayed.
4. Press **Down Arrow** to move down to the command level within the SYS MENU, "**1: RDGS STORE**" will be displayed.
5. Press **Down Arrow** to move down a level to set RDGS STORE function.
6. Use **Left Arrow** or **Right Arrow** key to set reading store function to ON or OFF.
7. Press **Auto**(ENTER) to confirm the ON/OFF selection. The message "**CHANGE SAVED**" will be displayed to show that the change is now in effect. TH1951 automatically exits the parameter level and moves up a level to the command level.
8. Use **Right Arrow** to move across to the RDGS COUNT command on the command level, "**2: RDGS COUNT**" will be displayed.
9. Press **Down Arrow** to move down a level to edit the number for storing.
10. Use **Left Arrow** and **Right Arrow** keys to choose a numerical place and use **Up Arrow** and **Down Arrow** keys to increment or decrement the digits. Enter a number for storing (from 2 to 512).
11. Press **Auto**(ENTER) to confirm the number for storing. The message "**CHANGE SAVED**" will be displayed to show that the change is now in effect. TH1951 will exit the parameter level and move up a level to the command level.
12. Press **Shift** → **Left Arrow** key to exit from the menu and return to the measurement status.
13. The asterisk (*) annunciator turns on to indicate a data storage operation. It will turn off when the storage is finished.

4.3.2 Recalling Readings

Use the following steps to recall stored readings and buffer statistics:

1. Press **Shift** → **Left Arrow** to enter the menu on the menu level, "**A: MEAS MENU**" will be displayed.
2. Use **Left Arrow** or **Right Arrow** key to move across to the SYS MENU on the menu level, "**D: SYS MENU**" will be displayed.
3. Press **Down Arrow** to move down to the command level within the SYS MENU, "**1: RDGS STORE**" will be displayed.

4. Use  or  key to move across to the SAVED RDGS command, “3: SAVED RDGS” will be displayed.
5. Press  to move down a level to view the stored readings. “MEM” annunciator turns on. If there is no reading stored, “BUFFER EMPTY” will be displayed for a moment.
6. Use  or  key to navigate through the reading numbers, reading values, and statistics.
7. Use the function keys or press  →  to exit from the menu and return to the measurement status.
- 8.

4.3.3 Buffer statistics

The MAX and MIN values are the maximum and minimum values in the buffer. The AVR value is the mean of the buffered readings. The equation used to calculation the mean is:

$$y = \frac{\sum_{i=1}^n X_i}{n}$$

Where: x_i is a stored reading
 n is the number of stored readings

The STD value is the standard deviation of the buffered readings. The equation used to calculate the standard deviation is:

$$y = \sqrt{\frac{\sum_{i=1}^n X_i^2 - \left(\frac{1}{n} \left(\sum_{i=1}^n X_i\right)^2\right)}{n-1}}$$

Where: x_i is a stored reading
 n is the number of stored readings.

4.4 Limit Operations

Limit operations set and control the values that determine the HI / IN / LO status of subsequent measurements. Limits can be applied to all measurement functions except continuity. The limit test is performed after mX+b and percent math operations. Unit prefixes are applied before the limit test, for example:

Low Limit = -1.0, High Limit = 1.0
 A 150mV reading equals 0.15V (IN).









Low Limit = -1.0, High Limit = 1.0
 A 0.6kΩ reading equals 600Ω (HI)

You can configure the multimeter to beep or not when readings are outside of the limit range.

4.4.1 Enabling limits























Use the following procedure to turn on the limit operation:

1. Press  →  to enter the menu on the menu level, “A: MEAS MENU” will be displayed.

2. Use  or  key to move across to the MATH MENU on the menu level, “**B: MATH MENU**” will be displayed.
3. Press  to move down to the command level within the MATH MENU, “**1: SET M**” will be displayed.
4. Use  or  key to move across to the LIMIT TEST command, “**6: LIMIT TEST**” will be displayed.
5. Press  to move down a level to set LIMIT TEST function to ON.
6. Press  (ENTER) to confirm the set of LIMIT TEST function. The message “**CHANGE SAVED**” will be displayed to show that the change is now in effect. TH1951 will exit the parameter level and move up a level to the command level.
7. Press  →  key to exit from the menu and return to the measurement status.
8. When the multimeter returns to the normal display, the HI/IN/LO status is displayed along with the reading.

4.4.2 Setting Limit Values

Use the following steps to enter high and low limit values:

1. Press  →  to enter the menu on the menu level, “**A: MEAS MENU**” will be displayed.
2. Use  or  key to move across to the MATH MENU on the menu level, “**B: MATH MENU**” will be displayed.
3. Press  to move down to the command level within the MATH MENU, “**1: SET M**” will be displayed.
4. Use  or  key to move across to the HIGH LIMIT command, “**7: HIGH LIMIT**” will be displayed.
5. Press  to move down a level to input the high limit value. The present high limit value will be displayed:
 HI: +1.00000Λ
6. Use  and  keys to choose a numerical place and use  and  keys to increment or decrement the digits. Enter an expected value for high limit.
7. Press  (ENTER) to confirm the value of high limit. The message “**CHANGE SAVED**” will be displayed to show that the change is now in effect. TH1951 will exit the parameter level and move up a level to the command level.
8. Use  or  key to move across to the LOW LIMIT command, “**8: LOW LIMIT**” will be displayed.
9. Press  to move down a level to input the low limit value. The present low limit value will be displayed:
 LO: -1.00000Λ
10. Use  and  keys to choose a numerical place and use  and  keys to increment or decrement the digits. Enter an expected value for low limit.
11. Press  (ENTER) to confirm the value of low limit. The message “**CHANGE SAVED**” will be displayed to show that the change is now in effect. TH1951 will exit the parameter level and move up a level to the command level.
12. Press  →  key to exit from the menu and return to the measurement status.

4.5 System Operations

Model TH1951 has some other operations. Beeper control, saving and restoring setup information, front panel display control, key sound control, self-test and calibration. These information is not directly related to making measurements but is an important part of operating the multimeter.

4.5.1 Beeper Control

Normally, the multimeter will emit a tone whenever certain conditions are met. For example: the multimeter will beep when a stable reading is captured in reading hold. You may want to disable the beeper for certain applications.

- When you disable the beeper, the multimeter will not emit a tone when:
 1. A limit is exceeded in a limit test
 2. A stable reading is captured in reading hold.
- Disabling the beeper has no effect on the tone generated when:
 1. An internal error is generated.
 2. The continuity threshold is exceeded.
 3. A front panel key is pressed.
- The beeper state is stored in non-volatile memory and does not change when power has been off or after a reset. The beeper is enabled when the multimeter is shipped from the factory.

Use the following steps to change the beeper's state:









1. Press **Shift** → **Left Arrow** to enter the menu on the menu level, "**A: MEAS MENU**" will be displayed.
2. Use **Left Arrow** or **Right Arrow** key to move across to the SYS MENU on the menu level, "**D: SYS MENU**" will be displayed.
3. Press **Down Arrow** to move down to the command level within the SYS MENU, "**1: RDGS STORE**" will be displayed.
4. Use **Left Arrow** or **Right Arrow** key to move across to the BEEP command, "**4: BEEP**" will be displayed.
5. Press **Down Arrow** to move down a level to set the beeper control.
6. Use **Left Arrow** or **Right Arrow** key to select ON or OFF.
7. Press **Auto**(ENTER) to confirm the beeper control. The message "**CHANGE SAVED**" will be displayed to show that the change is now in effect. TH1951 will exit the parameter level and move up a level to the command level.
8. Press **Shift** → **Left Arrow** key to exit from the menu and return to the measurement status.

4.5.2 Save Settings

Model TH1951 allows user to save the present settings. These settings are saved as files in non-volatile memory (Maximum 10 files can be stored: FILE-0 – FILE-9). Files will not be lost when power has been off or after a rest. User can restore the settings from the files when power on. Please refer to chapter 2 for factory default settings about saved file content.













To save present settings as user's setting, please follow steps below:

1. Press **Shift** → **Left Arrow** to enter the menu on the menu level, "**A: MEAS MENU**" will be displayed.
2. Use **Left Arrow** or **Right Arrow** key to move across to the SYS MENU on the menu level, "**D: SYS MENU**" will be displayed.

3. Press  to move down to the command level within the SYS MENU, "**1: RDGS STORE**" will be displayed.
4. Use  or  key to move across to the SAVE CNFG command, "**5: SAVE CNFG**" will be displayed.
5. Press  to move down a level to select a file to save.
6. Use  or  key to select a file from FILE-0 to FILE-9.
7. Press  (ENTER) to save the present setting to the selected file. The message "**FILE SAVING**" and "**SAVE SUCCEED**" will be displayed. TH1951 will exit the parameter level and move up a level to the command level.
8. Press  →  key to exit from the menu and return to the measurement status.

4.5.3 Restore Settings

Use the following steps to restore factory default setting (Described in Chapter 2) or user saved configuration (FILE-0 to FILE-9):





1. Press  →  to enter the menu on the menu level, "**A: MEAS MENU**" will be displayed.
2. Use  or  key to move across to the SYS MENU on the menu level, "**D: SYS MENU**" will be displayed.
3. Press  to move down to the command level within the SYS MENU, "**1: RDGS STORE**" will be displayed.
4. Use  or  key to move across to the LOAD CNFG command, "**6: LOAD CNFG**" will be displayed.
5. Press  to move down a level to select a file to restore.
6. Use  or  key to select the factory default setting or user saved configuration (FILE-0 to FILE-9).
7. Press  (ENTER) to restore the selected setting. The message "**FILE LOADING**" and "**LOAD SUCCEED**" will be displayed. TH1951 will exit the parameter level and move up a level to the command level.
8. Press  →  key to exit from the menu and return to the measurement status.









4.5.4 Display Control

To speed up measurement rate for remote control, Model TH1951 allows user to turn off the front panel display. You can also turn on the front panel display at remote control.

When the front panel display is turned off, readings are not sent to the display and some display annunciators still can be displayed. Front panel operation is unaffected by turning off the display. The display is enabled when power has been off or after a remote interface reset.

Use following steps for display control settings:













1. Press  →  to enter the menu on the menu level, "**A: MEAS MENU**" will be displayed.
2. Use  or  key to move across to the SYS MENU on the menu level, "**D: SYS MENU**" will be displayed.
3. Press  to move down to the command level within the SYS MENU, "**1: RDGS STORE**" will be displayed.

4. Use  or  key to move across to the DISPLAY command, “7: DISPLAY” will be displayed.
5. Press  to move down a level to set the display control.
6. Use  or  key to select ON or OFF for the front panel display.
7. Press  (ENTER) to confirm the selection. The message “CHANGE SAVED” will be displayed to show that the change is now in effect. TH1951 will exit the parameter level and move up a level to the command level.
8. Press  →  key to exit from the menu and return to the measurement status.

4.5.5 Key Sound

To avoid mis-operation, Model TH1951 has key sound function and you can enable or disable it. Factory default setting is enabled. The key sound state is stored in non-volatile memory and does not change when power has been off or after a reset.

Use following steps for key sound setting:

1. Press  →  to enter the menu on the menu level, “A: MEAS MENU” will be displayed.
2. Use  or  key to move across to the SYS MENU on the menu level, “D: SYS MENU” will be displayed.
3. Press  to move down to the command level within the SYS MENU, “1: RDGS STORE” will be displayed.
4. Use  or  key to move across to the KEY SOUND command, “8: KEY SOUND” will be displayed.
5. Press  to move down a level to enable or disable the key sound.
6. Use  or  key to turn ON or turn OFF the key sound.
7. Press  (ENTER) to confirm the selection. The message “CHANGE SAVED” will be displayed to show that the change is now in effect. TH1951 will exit the parameter level and move up a level to the command level.
8. Press  →  key to exit from the menu and return to the measurement status.

4.5.6 Self-test

The system Self-test is used as diagnostic tools to locate problems quickly for maintenance man.

A power-on self-test occurs automatically when you turn on Model TH1951 to assure you that the multimeter is operational. Power-on self-test is only part of self-test and does not include analog circuit self-test. Please refer to maintenance guide for the use and relative information about self-test.

4.5.7 Calibration

To make sure the instrument could achieve the designed performance, re-calibration and verification is required at least once a year. Instrument calibration could be performed either via the calibration menu from the front panel or through a remote control interface.

The CAL MENU can be used to view the calibration date, to view the number of times calibration has been performed and to perform calibration. Some of the items are password-protected to prevent accidental or unauthorized calibration of the multimeter.

Note: *To prevent destroying the calibration data stored in non-volatile memory, only the authorized service center or qualified individual can do the instrument calibration with desired equipment.*

For a more detailed discussion of calibration procedure, please contact the factory or the authorized agency.

Chapter 5 Remote Operation

Besides the front panel control, TH1951 supports RS-232 serial interface and GPIB parallel interface for remote control. You can use only one interface at a time. Standard Commands for Programmable Instruments (SCPI) is fully supported by the RS-232 and GPIB interfaces, however they use different hardware configurations and communication protocols.

This section includes the following information:

- Selecting an interface
- USB interface operation.
- RS-232 interface operation and reference
- GPIB bus operation and reference

5.1 Selecting an interface

Model TH1951 multimeter supports three built-in interfaces:

- USB device interface
- RS-232 interface(optional)
- GPIB bus interface (optional)

You can use only one interface at a time. The factory interface selection is the RS-232 interface. You can select the interface from the front panel. The interface selection is stored in non-volatile memory. It does not change when power has been off or after a remote interface reset.

5.1.1 USB

You can operate the USB device interface as if it's a RS232 interface from the computer, after the USB driver is installed. All the instrument setups for RS232 interface are applicable for the USB interface (or virtual RS232 interface). Please refer to RS-232 setup and operation.





5.1.2 RS-232

You can connect RS-232 interface with a computer. Some considerations will draw your attention:

- You must define the baud rate
- You must use the SCPI programming language

Perform the following steps to select RS-232 as the remote interface:

1. Press **Shift** → **Left Arrow** to enter the menu on the menu level, "**A: MEAS MENU**" will be displayed.
2. Use **Left Arrow** or **Right Arrow** key to move across to the I/O MENU on the menu level, "**E: I/O MENU**" will be displayed.
3. Press **Down Arrow** to move down to the command level within the I/O MENU, "**1: GPIB ADDR**" will be displayed.
4. Use **Left Arrow** or **Right Arrow** key to move across to the INTERFACE command, "**2: INTERFACE**" will be displayed.
5. Press **Down Arrow** to move down a level to select an interface.













6. Use  or  key to select USB interface.
7. Press  (ENTER) to confirm the selection. The message “**CHANGE SAVED**” will be displayed to show that the change is now in effect. TH1951 will exit the parameter level and move up a level to the command level.
8. Press  →  key to exit from the menu and return to the measurement status.

For more information about the RS-232 interface, see section RS-232 interface operation.

5.1.3 GPIB

The GPIB bus is the IEEE-488 interface. You must specify a unique address for the Model TH1951 multimeter. The factory default address is 8.

Perform the following steps to select GPIB as the remote interface:

1. Press  →  to enter the menu on the menu level, “**A: MEAS MENU**” will be displayed.
2. Use  or  key to move across to the I/O MENU on the menu level, “**E: I/O MENU**” will be displayed.
3. Press  to move down to the command level within the I/O MENU, “**1: GPIB ADDR**” will be displayed.
4. Use  or  key to move across to the INTERFACE command, “**2: INTERFACE**” will be displayed.
5. Press  to move down a level to select an interface.
6. Use  or  key to select GPIB interface.
7. Press  (ENTER) to confirm the selection. The message “**CHANGE SAVED**” will be displayed to show that the change is now in effect. TH1951 will exit the parameter level and move up a level to the command level.
8. Press  →  key to exit from the menu and return to the measurement status.

For more information about the GPIB interface, see section GPIB interface operation.

5.2 RS-232 Interface Operation

The instrument provides various remote commands. All operations from the front panel can be performed by a computer via the RS-232 interface.

5.2.1 RS-232 Connection

RS232C standard now is widely used as the serial communication standard. RS232 stands for Recommend Standard number 232 and C is the latest revision of the standard.

The serial ports on most instruments use a subset of the RS232C standard. The full RS232c standard specifies a 25-pin “D” connector of which 22 pins are used. Most of these pins are not needed for normal serial communications, and the common RS232 signals are listed in Table 5-1:

Table 5-1 Signal Definition for 9 Pin Connector

Function	Code	9 Pin Connector Pin Number
Request To Send	RTS	7
Clear To Send	CTS	8
Data Set Ready	DSR	6
Data Carrier Detect	DCD	1
Data Terminal Ready	DTR	4
Transmitted Data	TXD	3
Received Data	RXD	2
Signal Ground Common	GND	5

TH1951's serial port uses the transmit (TXD), receive (RXD), and signal ground (GND) lines of the RS232 standard. It does not use the hardware handshaking lines CTS and RTS. TH1951 only uses the smallest subset of the RS232C standard, the signals are listed in Table 5-2.

Table 5-2 Signal Definition for 9 Pin Connector

Function	Code	9 Pin Connector Pin Number
Transmitted Data	TXD	3
Received Data	RXD	2
Signal Ground Common	GND	5

Figure 5-1 shows the rear panel connector for the RS232 interface.



Figure 5-1 Rear Panel RS232 Interface

Connection between TH1951 and a computer shown as Figure 5-2:

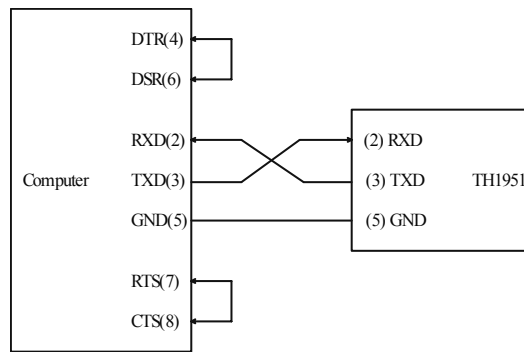

Figure 5-2 RS-232 Connection Sketch

There may be some difference between TH1951 RS232 interface and a standard RS232C interface. You can make the connection cable by yourself according the diagram or order one from our company.

Note: *Pin 4 and 6, pin 7 and 8 are shorted respectively at the end of controller.*

5.2.2 Sending and receiving data

Model TH1951 transfers data using 8 data bits, 1 stop bit, and none, even or odd parity. Each program message that is transmitted to the controller is terminated with <LF>, <CR>, or <LF><CR>.

5.2.3 Selecting Baud Rate

The baud rate is the rate at which Model TH1951 multimeter and the computer communicate. Choose one of these available rates:









- 38.4k
- 19.2k
- 9600
- 4800
- 2400
- 1200
- 600

Note: *Factory default baud rate is 9600.*

Before you choose a baud rate, make sure the programming terminal that you are connecting to the TH1951 can support the baud rate you selected. Both the multimeter and the other device must be configured for the same baud rate.

Perform the following steps to select a baud rate:













1. Press **Shift** → **Left Arrow** to enter the menu on the menu level, "**A: MEAS MENU**" will be displayed.
2. Use **Left Arrow** or **Right Arrow** key to move across to the I/O MENU on the menu level, "**E: I/O MENU**" will be displayed.
3. Press **Down Arrow** to move down to the command level within the I/O MENU, "**1: GPIB ADDR**" will be displayed.

4. Use  or  key to move across to the BAUD RATE command, “3: BAUD RATE” will be displayed.
5. Press  to move down a level to set the baud rate.
6. Use  or  key to select a baud rate.
7. Press  (ENTER) to confirm the selection. The message “CHANGE SAVED” will be displayed to show that the change is now in effect. TH1951 will exit the parameter level and move up a level to the command level.
8. Press  →  key to exit from the menu and return to the measurement status.

5.2.4 Selecting the Parity Mode

The instrument has three kinds of parity modes: NONE, EVEN, ODD.













Perform the following steps to select a Parity mode:

1. Press  →  to enter the menu on the menu level, “A: MEAS MENU” will be displayed.
2. Use  or  key to move across to the I/O MENU on the menu level, “E: I/O MENU” will be displayed.
3. Press  to move down to the command level within the I/O MENU, “1: GPIB ADDR” will be displayed.
4. Use  or  key to move across to the PARITY command, “4: PARITY” will be displayed.
5. Press  to move down a level to set the parity mode.
6. Use  or  key to select a parity mode.
7. Press  (ENTER) to confirm the selection. The message “CHANGE SAVED” will be displayed to show that the change is now in effect. TH1961 will exit the parameter level and move up a level to the command level.
8. Press  →  key to exit from the menu and return to the measurement status.

5.2.5 Selecting the Terminal Character

The instrument has three kinds of terminal characters: <LF>, <CR> and <LF><CR>.

Perform the following steps to select the terminal characters:

1. Press  →  to enter the menu on the menu level, “A: MEAS MENU” will be displayed.
2. Use  or  key to move across to the I/O MENU on the menu level, “E: I/O MENU” will be displayed.
3. Press  to move down to the command level within the I/O MENU, “1: GPIB ADDR” will be displayed.
4. Use  or  key to move across to the terminal character command, “5: TX TERM” will be displayed.
5. Press  to move down a level to set the terminal character.
6. Use  or  key to select a terminal character.
7. Press  (ENTER) to confirm the selection. The message “CHANGE SAVED” will be displayed to show that the change is now in effect. TH1961 will exit the parameter level and move up a level to the command level.
8. Press  →  key to exit from the menu and return to the measurement status.

5.2.6 Software Handshake ON/OFF

You can enable or disable the software handshake.

Perform the following steps to enable or disable software handshake.

1. Press **Shift** → **Left Arrow** to enter the menu on the menu level, "A: MEAS MENU" will be displayed.
2. Use **Left Arrow** or **Right Arrow** key to move across to the I/O MENU on the menu level, "E: I/O MENU" will be displayed.
3. Press **Down Arrow** to move down to the command level within the I/O MENU, "1: GPIB ADDR" will be displayed.
4. Use **Left Arrow** or **Right Arrow** key to move across to the PARITY command, "6: RETURN" will be displayed.
5. Press **Down Arrow** to move down a level to set the return on or off.
6. Use **Left Arrow** or **Right Arrow** key to select ON or OFF.
7. Press **Auto** (ENTER) to confirm the selection. The message "CHANGE SAVED" will be displayed to show that the change is now in effect. TH1961 will exit the parameter level and move up a level to the command level.
8. Press **Shift** → **Left Arrow** key to exit from the menu and return to the measurement status.

5.2.7 Software Protocol

Since the hardware handshaking lines CTS and RTS are not used by TH1951, the multimeter uses the character return method to decrease the data losses and errors during communication. Please refer to the content below before programming communication software.

1. For command syntax and format, refer to Chapter 6 Command Reference.
2. The controller transmits the command using the ASCII code with <LF>, <CR> or <LF><CR> as the terminal character. TH1951 executes the command after the terminal character is received.
3. The character received by TH1951 will be sent back to the controller again. The controller will not send the next character until the last returned character is received correctly from TH1951. If the controller fails to receive the character sent back by TH1951, the reasons are listed as follows:
 - The serial interface is not connected correctly.
 - Check if the RS232 function is enabled, if the same baud rate is selected for both TH1951 and the controller.
 - When TH1951 is busy with executing a bus command, TH1951 will not accept any character from the serial interface at the same time. So the character sent by controller will be ignored. In order to make sure the whole command is sent and received correctly, the character without a return character should be sent again by the controller.
4. TH1951 only sends information under following two conditions. The first is when a character is received normally; TH1951 will send the character back as a response when return function is ON. The second is when a query command is received; TH1951 will send the query response information.
5. Once a query command is received, TH1951 will send the query response information immediately even if the rest commands have not been finished. So if the command includes two queries, the controller should read the query responses twice. One query is recommended to be included in a single command.

6. A query response is sent out in ASCII codes with the preset terminal character.
7. Several query responses will be sent continuously with 1ms interval. The controller should be ready to receive the responses; otherwise the response information will be lost.
8. The controller should receive the preset query response terminal character. Otherwise you will confuse a terminal character with a returned character. At the same time the controller should receive the last returned character before receiving a query response.
9. For some commands that will take a long time to execute, for example reset command, the controller should keep waiting to avoid the next command being lost when TH1951 is executing the former command.

Please refer to Chapter 8 for serial interface program examples.

5.3 GPIB interface operation

This section contains information about GPIB bus standard, connecting to and using the GPIB interface.

5.3.1 GPIB Connection

When configuring a GPIB system, the following restrictions must be adhered to.

- The total length of cable in one bus system must be less than or equal to two meters times the number of devices connected on the bus (the GPIB controller counts as one device) and the total length of cable must not exceed 20 meters.
- A maximum of 15 devices can be connected on one bus system.
- There are no restrictions on how the cables are connected together. However, it is recommended that no more than four piggyback connectors be stacked together on any one device. The resulting structure could exert enough force on the connector mounting to damage it.

Figure 5-3 shows the GPIB interface on the rear panel of TH1951.

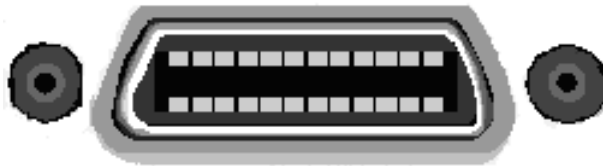

Figure 5-3 Rear Panel GPIB Interface

To allow many parallel connections to one instrument, stack the connector. Two screws are located on each connector to ensure that connections remain secure. Figure 5-4 shows a typical GPIB system interconnection.

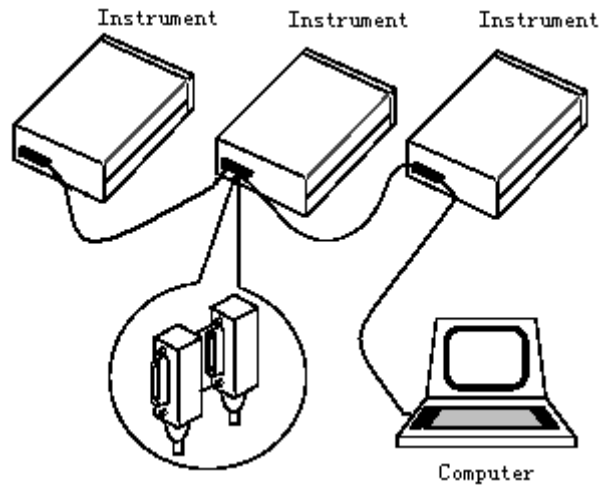

Figure 5-4 Typical GPIB System Interconnection

5.3.2 GPIB Interface Capability

Table 5-3 lists the TH1951's GPIB capabilities and functions. These functions provide the mean for an instrument to receive, process, and transmit commands, data, and status over the GPIB bus.

Table 5-3 GPIB interface Capability

Code	Function
SH1	Complete Source Handshake capability
AH1	Complete Acceptor Handshake capability
T5	Basic Talker; Talk-Only; Unaddressed if MLA; no serial poll.
L4	Basic Listener; Unaddressed if MTA; no Listen Only.
RL1	Remote/Local capability
DC1	Device Clear capability
DT1	Device Trigger capability
C0	No controller capability
E1	Drivers are open-collector

5.3.3 GPIB Addressing

Model Th1951 multimeter ships from the factory with a GPIB address of 8. You can set the address to a value of 0 to 30 and the address is saved in the non-volatile memory. Do not assign the same address to another device or a controller that are on the same GPIB bus system.

Perform the following steps to set the GPIB address of Model TH1951 multimeter:

1. Press **Shift** → **Left Arrow** to enter the menu on the menu level, "**A: MEAS MENU**" will be displayed.
2. Use **Left Arrow** or **Right Arrow** key to move across to the I/O MENU on the menu level, "**E: I/O MENU**" will be displayed.
3. Press **Down Arrow** to move down to the command level within the I/O MENU, "**1: GPIB ADDR**" will be displayed.
4. Use **Left Arrow** and **Right Arrow** keys to choose a numerical place and use **Up Arrow** and **Down Arrow** keys to increment or decrement the digits. Enter an expected value for GPIB address (from 0 to 31).
5. Press **Auto** (ENTER) to confirm the address. The message "**CHANGE SAVED**" will be displayed to

show that the change is now in effect. TH1951 will exit the parameter level and move up a level to the command level.

6. Press **Shift** → **Left Arrow** key to exit from the menu and return to the measurement status.

5.3.4 General Bus Commands

General commands are those commands, such as DCL, that have the same general meaning regardless of the instrument. Table 5-4 lists the general bus commands along with the programming statement for each command.

Table 5-4 General bus commands and associated statements

Command	Programming statement	Effect on Model TH1951 Multimeter
REM	REMOTE 8	Goes into effect when next addressed to listen
IFC	ABORT 8	Goes into talker and listener idle states
LLO	LOCAL LOCKOUT	LOCAL keys locked out
GTL	LOCAL 8	Cancel remote; Restore front panel operation for the multimeter.
DCL	CLEAR	Return all devices to known conditions.
SDC	CLEAR 8	Return the TH1951 to known condition
GET	TRIGGER 8	Initiates a trigger
SPE, SPD	S POLL 8	Serial Polls the TH1951

For SCPI commands, please refer to Chapter 6: SCPI Command reference

5.4 Data Format

TH1951 outputs the measurement results using the ASCII character string format via the GPIB bus. The data format is described in the following Figure 5-5.

<p>SD.DDDDDDESDDD<NL> S: +/- D: number 0 to 9 E: exponent sign (“+”is omitted) <NL>: New Line, ASCII code is 10</p>

Figure 5-5 Data Format

Chapter 6 SCPI Command Reference

This chapter provides descriptions of all TH1951's available GPIB commands which correspond to Standard Commands for Programmable Instruments (SCPI) command sets. Use this chapter as a reference.

6.1 Command structure

TH1951 commands are divided into two types: GPIB common commands and SCPI commands. The GPIB common commands are defined in IEEE std. 488.2-1987, and these commands are common for all devices. Not all GPIB commands are supported by the TH1951. The SCPI commands are used to control all of the TH1951's functions. The SCPI commands are tree structured three levels deep. (The highest level commands are called the subsystem commands in this manual.) So the lower level commands are legal only when the subsystem commands have been selected. A colon (:) is used to separate the higher level commands and the lower level commands. See Figure 6-1 for a sample.

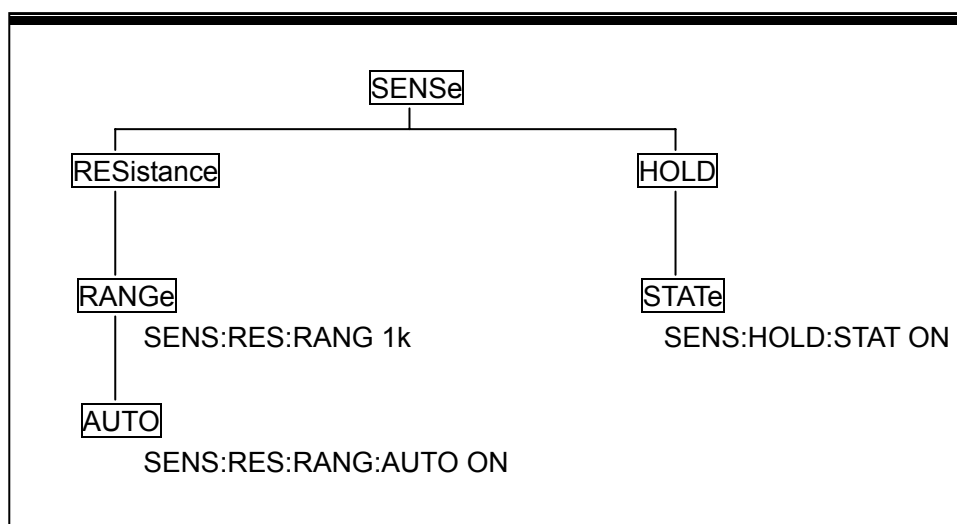

Figure 6-1 Command Tree Example

6.2 Command Syntax

The information in this section covers the syntax for both common commands and SCPI commands.

6.2.1 Commands and command parameters

Common commands and SCPI commands may or may not use a parameter. The following are some examples:

*RST	No parameter used
:FORMat <name>	Parameter<name> required
:IMMediate	No parameter used

Put at least one space between the command word and the parameter.

- Brackets []: Some command words are enclosed in brackets. These brackets are used to denote an optional command word that does not need to be included in the program message. For example:

:RANGe[:UPPer] <n>

These brackets indicate that :UPPer is optional and does not have to be used. Thus, the above command can be sent in one of the two ways below:

:RANGe <n>
or :RANGe:UPPer <n>

NOTICE: When using optional command words in your program, do not include the brackets.

- Angel brackets <>: Angle brackets are used to denote a parameter type. Do not include the brackets in the program message. For example:

:HOLD:STATe

The indicates that a Boolean-type parameter is required. Thus, to enable the HOLD feature, you must send the command with ON or 1 parameter as below:

:HOLD:STATe ON
or :HOLD:STATe 1

- Parameter types: The following are some of the more common parameter types:
 Boolean: Used to enable or disable an instrument operation. 0 or OFF disables the operation and 1 or ON enables the operation. Example:

:CURRent:AC:RANGe:AUTO ON Enable autoranging

<name> Name parameter: Select a parameter name from a listed group. Example:

<name> = MOVing
REPeat

:RESistance:AVERage:TCONtrol MOVing

<NRf> Numeric Representation format: This parameter is a number that can be expressed as an integer (e.g., 6), a real number (e.g., 25.3) or an exponent (e.g., 5.6E2). Example:

:MMFactor 5

<n> Numeric value: A numeric value parameter can consist of a NRf number or one of the following name parameters: DEFault, MINimum, MAXimum. When DEFault parameter is used, the instrument is programmed to the *RST default value. When the MINimum parameter is used, the instrument is programmed to the lowest allowable value. When the MAXimum parameter is used, the instrument is programmed to the largest allowable value. Examples:

```
[:SENSe[1]:CURRent[:DC]:NPLCycles 1
[:SENSe[1]:CURRent[:DC]:NPLCycles DEFault
[:SENSe[1]:CURRent[:DC]:NPLCycles MINimum
[:SENSe[1]:CURRent[:DC]:NPLCycles MAXimum
```

6.2.2 Short-form Rules

Use the following rules to determine the short-form version of any SCPI command:

- If the length of the command word is four letters or less, no short form version exists. Example:
:AUTO = :AUTO
- These rules apply to command words that exceed four letters:
- If the fourth letter of the command word is a vowel, delete it and all the letters after it. Example:
:immediate = :imm
- Rule exception – The short form version of the following command uses only the first two letters of the word.
:TCouple = :tc
- If the fourth letter of the command word is a consonant, retain it but drop all the letters after it. Example:
:format = :form
- If the command contains a question mark (?; query) or a non-optional number included in the command word, you must include it in the short-form version. Example:
:delay? = :del?
- Command words or characters that are enclosed in brackets ([]) are optional and need not be included in the program message.

6.2.3 Basic Rules of Command Structure

- Letter case (upper and low) is ignored.
For example:
FUNC:VOLT:DC = func:volt:dc = Func:Volt:Dc
- Spaces (␣ is used to indicate a space) must not be placed before and/or after the colon (:).
For example:
(wrong) FUNC␣:␣VOLT:DC
(right) FUNC: VOLT:DC
- The command can be completely spelled out or in abbreviated type. (In the following description, short form will be printed in upper case.)
For example:
FUNCTION: VOLTAGE:DC = FUNC: VOLT:DC
- The command header should be followed by a question mark (?) to generate a query for that

command.

For example:

FUNC?

6.2.4 Multiple Command Rules

The semicolon (;) can be used as a separator to execute multiple commands on a single line. The multiple command rules are as follows.

- Commands at the same level and in the same subsystem command group can be separated by a semicolon (;) on a multiple command line.

For example:

CALCulate3:LIMit[1]:STATe ;STATe?

- To restart commands from the highest level, a semicolon (;) must be used as the separator, and then a leading colon (:), which shows that the restarted command is a command at the top of the command tree, must follow.

For example:

:CALCulate[1]:FORMat?;;CALCulate[1]:KMATH:MMFactor <NRf>

- The GPIB common commands can restart only after a semicolon on a multiple command line.

For example,

CALCulate3:LIMit[1]:STATe *IDN?

6.2.5 Command Path Rules

- Each new program message must begin with the root command, unless it is optional (e.g., [:SENSe]). If the root is optional, simply treat a command word on the next level as the root.
- The colon at the beginning of a program message is optional and need not be used. Example:
:DISPlay:ENABle = DISPlay:ENABle
- When the path pointer detects a colon(;), it moves down to the next command level.
- When the path pointer detects a colon(:) after a semicolon (;), it resets back to the root level.
- The path pointer can only move down. It cannot be moved up a level. Executing a command at a higher level requires that you start over at the root command.

6.3 Command Reference

Model TH1951 provides following subsystem commands:

◆ DISPlay ◆ CALCulate ◆ SENSe ◆ SYSTem ◆ UNIT ◆ TRIGger

Model TH1951 supports following common commands:

◆ *RST ◆ *TRG ◆ *IDN

6.3.1 SCPI Signal Oriented Measurement Commands

The signal oriented measurement commands are used to acquire readings. You can use these high-level instructions to control the measurement process. These commands are summarized in Table 6-1.

Table 6-1 Signal Oriented Measurement Command Summary

Command	Function Description
MEASure:<function>? :CONFigure:<function>	Perform an :ABORt, :CONFigure:<function>, and a :READ? Configure TH1951 in a “one-shot” measurement mode for a specified function.
:FETCh?	Request the latest reading.
:READ?	Perform an :ABORt, :INITiate, and a :FETCh?

MEASure command

Command syntax:

:MEASure:<function>?

Command parameter :

<function> = VOLTage[:DC]	DC voltage
VOLTage:AC	AC voltage
CURRent[:DC]	DC current
CURRent:AC	AC current
RESistance	2-wire resistor
FRESistance	4-wire resistor
FREQuency	Frequency
PERiod	Period
DIODE	Diode testing
CONTInuity	Continuity test

Description:

This command combines all of the other signal oriented measurement commands to perform a “one-shot” measurement and acquire the reading.

When this command is sent, the following commands execute in the order that they are presented.

:ABORt

:CONFigure:<function>

:READ?

When :ABORt is executed, if continuous initiation is disabled, the instrument goes into the idle state. If continuous initiation is enabled, the operation re-starts at the beginning of the Trigger Model.

When :CONFigure is executed, the instrument goes into a “one-shot” measurement mode.

When :READ? is executed, its operation will then be performed. In general, another :ABORt is performed, then an :INITiate, and finally a FETCh? to acquire the reading.

CONFigure Command

Command syntax:

:CONFigure:<function>

Command parameter :

<function> = VOLTage[:DC]	DC voltage
VOLTage:AC	AC voltage
CURRent[:DC]	DC current
CURRent:AC	AC current
RESistance	2-wire resistor
FRESistance	4-wire resistor
FREQuency	Frequency
PERiod	Period
DIODe	Diode testing
CONTInuity	Continuity test

Query:

:CONFigure? Query the selected function.

Description:

This command configures the instrument for subsequent measurements on the specified function. Basically, this command places the instrument in a “one-shot” measurement mode. You then use the :READ? command to trigger a measurement and acquire a reading.

When this command is sent, the TH1951 will be configured as follows:

- The function specified by this command is selected.
- All controls related to the selected function are defaulted to the *RST values.
- Continuous initiation is disabled.
- The control source of the Trigger Model is set to Immediate.
- The count values of Trigger Model are set to one.
- The delay of the Trigger Model is set zero.
- All math calculations are disabled.
- Buffer operation is disabled. A storage operation currently in process will be aborted.
- Autozero is set to the *RST default value.
-

This command is automatically added when the :MEASure? Command is sent.

FETCh? Command

Command syntax:

:FETCh?

Description:

This query command is used to obtain the latest post-processed reading. This command does not affect the configuration of the instrument.

This command does not trigger a measurement. The command simply requests the last available reading. This command continues to return the same old reading, until there is a new reading.

This command will be automatically asserted when :READ? or :MEASure? command is sent.

READ? Command

Command syntax:

:READ?

Description:

Typically, this command is used with the instrument in the “one-shot” measurement mode to trigger and acquire a specified number of readings. The :SAMPle:COUNT command is used to specify the number of readings (see Trigger Subsystem). Note that the readings are stored in the buffer.

When this command is sent, the following commands execute in the order that they are presented:

:ABORt

:INITiate

:FETCh?

When :ABORt is executed, if continuous initiation is disabled, the instrument goes into the idle state. If continuous initiation is enabled, the operation re-starts at the beginning of the Trigger Model.

If the instrument is in the idle state, :INITiate takes the instrument out of the idle state. If continuous initiation is enabled, (:INITiate:CONTInuous ON), then the :INITiate command generates an error and ignores the command.

See the :FETCh? command for more details. Note that an “Init ignored” error will not cancel the execution of the :FETCh? command.

NOTE: *You cannot use the :READ? command if sample count >1 (see Trigger Subsystem) and there are readings stored in the buffer (error -225, out of memory). Either set sample count to one or clear the buffer.*

6.3.2 DISPLAY subsystem

The DISPLAY subsystem commands are mainly used to control the display of the TH1951. and are summarized in Table 6-2.

Table 6-2 DISPLAY Subsystem Commands Summary

Command	Function Description
:DISPlay	
:ENABle 	Enable or disable front panel dispaly
:ENABle?	Query state of the display

**:ENABLE **

Command syntax:

:DISPlay:ENABle

Command Parameter:

 = 0 or OFF	Disable front panel display
1 or ON	Enable front panel display

Query:

:ENABle? Query state of the display

Description:

This command is used to enable or disable front panel display circuitry. When disabled, the instrument operates at a higher speed. While disabled, the display is frozen. All front panel controls except LOCAL are disabled. Normal display operation can be resumed by using :ENABle command or pressing LOCAL key to enable the display.

6.3.3 CALCulate Subsystem

The commands in this subsystem are used to configure and control the calculate subsystems and are summarized in Table 6-3.

Table 6-3 CALCulate Command Summary

Command	Function Description	Default Parameter
:CALCulate[1]	Subsystem to control CALC1:	
:FORMat <name>	Select math format (NONE,MXB,PERCent)	PERCent
:FORMat?	Query math format.	
:KMATH	Path to configure math calculations:	
:MMFactor <NRf>	Set "m" factor for mx+b (-100e6 to 100e6)	1
:MMFactor?	Query "m" factor	
:MBFactor <NRf>	Set "b" factor for mx+b (-100e6 to 100e6)	0
:MBFactor?	Query "b" factor	
:PERCent <NRf>	Set target value for PERCent calculation(-100e6 ~100e6)	1
:ACQuire	Use input signal as target value.	
:PERCent?	Query percent	
:STATe 	Enable or disable KMATH calculation	
:STATe?	Query state of KMATH calculation	
:DATA?	Read result of KMATH calculation	
:CALCulate2	Subsystem to control CALC2	
:TRACe		
:CLEAr	Clear readings in the buffer.	
:POINts <NRf>	Specify the size of buffer (2 to 512)	
:POINts?	Query buffer size.	
:DATA?	Read all readings in the buffer.	
:FORMat <name>	Select Math format.	
:FORMat?	Query math format.	NONE
:STATe 	Enable or disable calculation	
:STATe?	Query state of math function	
:IMMediate	Recalculate raw input date in buffer	
:IMMediate?	Perform calculation and read result	
:DATA?	Read math result of CALC2	
:CALCulate3	Subsystem to control CALC3 (limit test):	
:LIMit[1]	Path to control LIMIT test:	
:UPPer <n>	Set upper limit (-100e6 to 100e6).	
:UPPer?	Query upper limit.	1
:LOWer <n>	Set lower limit (-100e6 to 100e6).	
:LOWer?	Query lower limit	-1
:STATe 	Enable or disable limit test	
:STATe?	Query state of limit test	OFF
:FAIL?	Query test result (1=pass, 0=fail)	

:CALCulate[1]

Use these commands to configure and control MXB and percent math calculations.

:FORMat <name>

Command syntax:

:CALCulate[1]:FORMat <name>

Command Parameter:

<name> =	NONE	No calculations
	MXB	Polynomial math calculation
	PERCent	Percent math calculation

Query:

:FORMat? Query programmed math format

Description:

This command is used to specify the format for the CALC1 math calculations. With NONE selected, no CALC1 calculation is performed. With MXB or PERCent selected and enabled, the result of the calculation is displayed. The calculated reading is refreshed every time the instrument takes a reading.

:KMATH Commands

:MMFactor <NRf>

Command syntax:

:CALCulate[1]:KMATH:MMFactor <NRf>

Command Parameter:

<NRf> =	-100e6 to 100e6	Specify "m" factor.
---------	-----------------	---------------------

Query:

:MMFactor? Query "m" factor.

Description:

This command is used to define the "m" factor for the mx+b calculation.

:MBFactor <NRf>

Command syntax:

:CALCulate[1]:KMATH:MBFactor <NRf>

Command Parameter:

<NRf> =	-100e6 to 100e6	Specify "b" factor.
---------	-----------------	---------------------

Query:

:MBFactor? Query "b" factor

Description:

This command is used to define the “b” factor for the mx+b calculation.

:PERCent <NRf>

Command syntax:

:CALCulate[1]:KMAth:PERCent <NRf>

Command Parameter:

<NRf> = -1e6 to 1e6 Specify target value.

Query:

:PERCent? Query percent target value

Description:

This command is used to specify the target value for the percent calculation.

:ACQuire

Command syntax:

:CALCulate[1]:KMAth:PERCent:ACQuire

Description:

This action command is used to acquire the present input signal reading and use it as the target value for the PERCent calculation.

**:STATe **

Command syntax:

:CALCulate[1]:STATe

Command Parameter:

 = 0 or OFF Disable CALC1 calculation.
1 or ON Enable CALC1 calculation.

Query:

:STATe? Query state (ON or OFF) of CALC1.

Description:

This command is used to enable or disable the CALC1 calculation. When enabled, each instrument reading will reflect the selected calculation.

:DATA?

Command syntax:

:CALCulate[1]:DATA?

Description:

This query command is used to read the result of the CALC1 calculation. If CALC1 is disabled or

NONE is selected, the “raw” reading will be read.

:CALCulate2

These commands are used to configure and control the CALC2 operations on readings stored in the buffer.

:TRACe Command

:CLEar

Command syntax:

:CALCulate2:TRACe:CLEar

Description:

This action command is used to clear the readings in the buffer. If the buffer is not cleared, a subsequent store will overwrite the old readings. If the subsequent store is aborted before the buffer becomes full, you could end up with some “old” readings still in the buffer.

:PIONts <NRf>

Command syntax:

:CALCulate2:TRACe:POINts <NRf>

Command Parameter:

<NRf> = 2 to 512 Specify buffer size.

Query:

:POINts? Query buffer size.

Description:

This command is used to specify the buffer size for readings saving.

:DATA?

Command syntax:

:CALCulate2:TRACe:DATA?

Description:

When this command is sent and TH1951 is addressed to talk. All the readings stored in the buffer are sent to the computer.

:FORMat <name>

Command syntax:

:CALCulate2:FORMat <name>

Command Parameter:

<name> =	NONE	No calculation
	MEAN	Mean value of readings in buffer

SEdViation Standard deviation of readings in buffer
MAXimum Largest reading in buffer
MINimum Lowest reading in buffer

Query:

:FORMat? Query programmed math format.

Description:

This command is used to specify the format for the CALC2 math calculation. The calculation operations for CALC2 use data stored in the buffer.

With NONE selected, no CALC2 calculation is performed. With any of the other formats selected and CALC2 enabled, the math calculation will be performed every time the :IMMediate or :IMMediate? Command is executed.

**:STATe **

Command syntax:

:CALCulate2:STATe

Command Parameter:

 = 0 or OFF Disable CALC2 calculation
1 or ON Enable CALC2 calculation

Query:

:STATe? Query state (ON or OFF) of CALC2

Description:

This command is used to enable or disable the CALC2 calculation. When enabled, the selected CALC2 format will be calculated when the :IMMediate or :IMMediate? Command is executed.

:DATA?

Command syntax:

:CALCulate2:DATA?

Description:

This query command is used to read the result of the CALC2 calculation. If CALC2 is disabled or NONE is selected, the "raw" reading will be read.

:CALCulate3

These commands are used to configure and control the CALC3 limit test.

:LIMit[1]:UPPer <n> Specify upper limit

:LIMit[1]:LOWer <n> Specify lower limit

Command syntax:

:CALCulate3:LIMit[1]:UPPer <n>

:CALCulate3:LIMit[1]:LOWer <n>

Command Parameter:

<n> =	-100e6 to 100e6	Specify limit value
	DEFault	Specify upper limit to 1
		Specify lower limit to -1
	MINimum	Specify limit to -100e6
	MAXimum	Specify limit to +100e6

Query:

:UPPer?	Query upper limit
:LOWer?	Query lower limit

Description:

This command is used to specify the upper and lower limit for LIMIT1. The actual limit depends on which measurement function is currently selected. For example, a limit value of 1 is 1V for the volts functions (DCV or ACV), 1A for the current function (DCI or ACI), 1Ω on the ohms functions (2 or 4). A limit value is not range sensitive. A limit of 1 for DCV is 1V on all measurement ranges.

**:STATe **

Command syntax:

:CALCulate3:LIMit[1]:STATe

Command Parameter:

 =	0 or OFF	Disable limit test
	1 or ON	Enable limit test

Query:

:STATe?	Query state (on or off) of limit test
---------	---------------------------------------

Description:

This command is used to enable or disable the LIMIT test. When enabled, the limit test will be performed.

:FAIL?

Command syntax:

:CALCulate3:LIMit[1]:FAIL?

Description:

This command is used to read the results of the LIMIT1 test

0 = Limit test failed

1 = Limit test passed

The response message (0 or 1) only tells you if a limit test has passed or failed. It does not tell you which limit (upper or lower) has failed.

6.3.4 SENSE subsystem command

This SENSE subsystem is used to configure and control Model TH1951 measurement functions and are summarized in Table 6-4.

Table 6-4 SENSE Command Summary

Command	Function Description	Default
[:SENSE[1]] :FUNCTION<name>	Select measurement function: 'VOLTage:AC', 'VOLTage:DC', 'RESistance', 'FRESistance', 'CURRent:AC', 'CURRent:DC', 'FREQUency', 'PERiod', 'DIODE', 'CONTInuity'.	VOLT:DC
:FUNCTION?	Query function.	
:DATA?	Output the latest reading	
:HOLD	Path to control Hold feature:	
:WINDow <NRf>	Set Hold window(%); 0.01 to 10	1
:WINDow?	Query Hold window	
:COUNT <NRf>	Set Hold count; 2 to 100	5
:COUNT?	Query HOLD count	
:STATe <NRf>	Enable or disable HOLD	OFF
:STATe?	Query state of HOLD	
:CURRent:AC	Path to configure AC current	
:NPLCycles <n>	Set A/D integration rate (Line cycle; 0.1 to 10)	1
:NPLCycles?	Query line cycle integration rate	
:RANGE	Path to configure measurement ranges	
[:UPPer] <n>	Select range (0 to 10)	10
[:UPPer]?	Query range	
:AUTO 	Enable or disable auto range	ON
:AUTO?	Query auto range	
:REFerence <n>	Specify reference (-10 to 10)	0
:STATe 	Enable or disable reference	OFF
:STATe?	Query state of reference	
:ACQuire	Use input signal as reference	
:REFerence?	Query reference value	
:AVERage	Path to configure and control the filter	
:TCONtrol <name>	Select filter type(MOVing or REPeat)	
:TCONtrol?	Query filter type	
:COUNT <n>	Specify filter count (1 to 100)	5
:COUNT?	Query filter count	
:STATe 	Enable or disable filter	OFF
:STATe?	Query state of digital filter	

Table 6-4 SENSE Command Summary (cont.)

Command	Function Description	Default
:CURRent:DC	Path to configure DC current	
:NPLCycles <n>	Set integration rate(line cycles; 0.1 to 10)	1
:NPLCycles?	Query line cycle integration rate	
:RANGe	Path to configure measurement range	
[:UPPer] <n>	Select range (0 to 10)	10
[:UPPer]?	Query range	
:AUTO 	Enable or disable auto range	ON
:AUTO?	Query auto range	
:REFerence <n>	Specify reference (-10 to 10)	0
:STATe 	Enable or disable reference	OFF
:STATe?	Query state of reference	
:ACQuire	Use input signal as reference	
:REFerence?	Query reference value	
:AVERage	Path to configure and control the filter	
:TCONtrol <name>	Select filter type (MOVing or REPeat)	
:TCONtrol?	Query filter type	
:COUNt <n>	Specify filter count (1 to 100)	5
:COUNt?	Query filter count	
:STATe 	Enable or disable filter	OFF
:STATe?	Query state of digital filter	
:VOLTage:AC	Path to configure AC voltage	
:NPLCycles <n>	Set integration rate (line cycles; 0.1 to 10)	1
:NPLCycles?	Query line cycle integration rate	
:RANGe	Path to set measurement range	
[:UPPer] <n>	Select range (0 to 757.5)	757.5
[:UPPer]?	Query range	
:AUTO 	Enable or disable auto range	ON
:AUTO?	Query auto range	
:REFerence <n>	specify reference (-757.5 to 757.5)	0
:STATe 	Enable or disable reference	OFF
:STATe?	Query state of reference	
:ACQuire	Use input signal as reference	
:REFerence?	Query reference value	
:AVERage	Path to configure and control the filter	
:TCONtrol <name>	Select filter type: MOVing or REPeat	
:TCONtrol?	Query filter type	
:COUNt <n>	Specify filter count (1~100)	5
:COUNt?	Query filter count	
:STATe 	Enable or disable filter	OFF
:STATe?	Query state of digital filter	

Table 6-4 SENSE Command Summary (cont.)

Command	Function Description	Default
:VOLTage:DC	Path to configure DC voltage	
:NPLCycles <n>	Set integration rate (line cycle; 0.1 to 10)	1
:NPLCycles?	Query line cycle integration rate	
:RANGe	Path to configure measurement range	
[:UPPer] <n>	Select range (0 to 1010)	1000
[:UPPer]?	Query range	
:AUTO 	Enable or disable auto range	ON
:AUTO?	Query auto range	
:REFerence <n>	Specify reference (-1010 to 1010)	0
:STATe 	Enable or disable reference	OFF
:STATe?	Query state of reference (0,1)	
:ACQuire	Use input signal as reference.	
:REFerence?	Query reference value	
:AVERage	Path to configure and control the filter	
:TCONtrol <name>	Select filter type (MOVing, REPeat)	
:TCONtrol?	Query filter type	
:COUNT <n>	Specify filter count (1~100)	5
:COUNT?	Query filter count	
:STATe 	Enable or disable filter	OFF
:STATe?	Query state of digital filter	
:RESistance	Path to configure 2-wire resistance	
:NPLCycles <n>	Set integration rate (line cycles: 0.1 to 10)	1
:NPLCycles?	Query line cycle integration rate	
:RANGe	Path to configure measurement range	
[:UPPer] <n>	Select range (0 to 120e6)	100e6
[:UPPer]?	Query range	
:AUTO 	Enable or disable auto range	ON
:AUTO?	Query auto range	
:REFerence <n>	Specify reference (0 to 120e6)	0
:STATe 	Enable or disable reference	OFF
:STATe?	Query state of reference	
:ACQuire	Use input signal as reference	
:REFerence?	Query reference value	
:AVERage	Path to configure and control filter	
:TCONtrol <name>	Select filter type (MOVing, REPeat)	
:TCONtrol?	Query filter type	
:COUNT <n>	Specify filter count (1~100)	5
:COUNT?	Query filter count	
:STATe 	Enable or disable filter	OFF
:STATe?	Query state of digital filter	

Table 6-4 SENSE Command Summary (cont.)

Command	Function description	Default
:FRESistance	Path to configure 4-wire resistance	
:NPLCycles <n>	Set integration rate (line cycle: 0.1 to 10)	1
:NPLCycles?	Query line cycle integration rate	
:RANGe	Path to configure measurement range	
[:UPPer] <n>	Select range (0 to 120e6)	100e6
[:UPPer]?	Query range	
:AUTO 	Enable or disable auto range	ON
:AUTO?	Query auto range	
:REFERence <n>	Specify reference(0 to 1201e6)	0
:STATe 	Enable or disable reference	OFF
:STATe?	Query state of reference	
:ACQuire	Use input signal as reference	
:REFERence?	Query reference value	
:AVERage	Path to configure and control filter	
:TCONtrol <name>	Select filter type (MOVing, REPeat)	
:TCONtrol?	Query filter type	
:COUNt <n>	Specify filter count (1 to 100)	5
:COUNt?	Query filter count	
:STATe 	Enable or disable filter	OFF
:STATe?	Query state of digital filter	
:FREQuency	Path to configure frequency	
:THReshold	Path to select the threshold voltage range:	
:VOLTage		
:RANGe <n>	Select threshold range (0 to 750).	10
:RANGe?	Query threshold range	
:REFERence <n>	Specify reference (0 to 1.5e7)	0
:STATe 	Enable or disable reference	OFF
:STATe?	Query state of reference	
:ACQuire	Use input signal as reference	
:REFERence?	Query reference value	
:PERiod	Path to configure period	
:THReshold	Path to select the threshold voltage range:	
:VOLTage		
:RANGe <n>	Select threshold range (0 to 750).	10
:RANGe?	Query threshold range	
:REFERence <n>	Specify reference(0 to 1)	0
:STATe 	Enable or disable reference	OFF
:STATe?	Query state of reference	
:ACQuire	Use input signal as reference	
:REFERence?	Query reference value	

Table 6-4 SENSE Command Summary (cont.)

Command	Function description	Default
:DIODE :CURRent :RANGe [:UPPer] <NRf> [:UPPer]?	Path to configure diode test Path to select range Select range(0 to 1e-3) Query range	1e-3
:CONTInuity :THReshold <NRf> :THReshold?	Path to configure continuity test Specify threshold resistance (1 to 1000) Query threshold resistance	10

:[SENSE[1]] Subsystem

:FUNCTION Command

:FUNCTION <name>

Command syntax:

:[SENSE[1]]:FUNCTION <name>

Command Parameter:

<name> =	'VOLTage:AC'	Select AC Voltage
	'VOLTage[:DC]'	Select DC Voltage
	'CURRent:AC'	Select AC Current
	'CURRent[:DC]'	Select DC Current
	'RESistance'	Select 2-wire Resistance
	'FRESistance'	Select 4-wire Resistance
	'FREQuency'	Select Frequency
	'PERiod'	Select Period
	'DIODE'	Select Diode Testing
	'CONTInuity'	Select Continuity Testing

Query:

:FUNCTION? Query currently programmed function

Description:

This command is used to select the measurement function of the instrument. Note that the parameter names are enclosed in single quotes ('). However, double quotes (") can instead be used. For example:

:FUNC 'VOLT'= :FUNC "VOLT"

Each measurement function "remembers" its own unique setup configuration, such as range, speed, filter and rel. This eliminates the need to re-program setup conditions every time you switch from one function to another.

:DATA?

Command syntax:

[[:SENSe[1]]]:DATA?

Description:

This query command is used to read the latest instrument reading. This command returns the “raw” reading or a reading that is the result of the reference (REL from the front panel) operation. For example, if a reference value of 1.0 is established, the reading returned by this command is the “raw” reading minus 1.0. Calculated (MATH) readings cannot be read with this command (See the CALCulate subsystem for information on how to read math calculations). The reading is returned in exponent form. For example, a 10V DC reading will be displayed on the CRT as follows: +1.000000E+01.

Notice that the measurement function is not included in the response message. Thus, you may want to perform a function query after a reading query.

:HOLD Command

The following commands are used to configure and control the HOLD feature.

:WINDow <NRf>

Command syntax:

[[:SENSe[1]]]:HOLD:WINDow <NRf>

Command Parameter:

<NRf> = 0.01 to 10 Set window (percent)

Query:

:WINDow? Query Hold window

Description:

This command is used to set the window for HOLD. This window is expressed as a percent of the “seed” reading for the Hold process.

:COUNT <NRf>

Command syntax:

[[:SENSe[1]]]:HOLD:COUNT <NRf>

Command Parameter:

<NRf> = 2 to 100 Specify HOLD count

Query:

:COUNT? Query HOLD count.

Descripton:

This command is used to specify the count for HOLD. COUNT is the number of readings that are compared to the “seed” reading during the HOLD process.

**:STATe **

Command syntax:

[[:SENSe[1]]]:HOLD:STATe

Command Parameter:

 =	0 or OFF	Disable HOLD
	1 or ON	Enable HOLD

Query:

:STATe? Query state of HOLD

Description:

This command is used to enable or disable HOLD.

Speed Commands

: NPLCycles <n>

Command Systac:

[[:SENSe[1]]]:CURRent:AC:NPLCycles <n>	Set NPLC for ACI
[[:SENSe[1]]]:CURRent[:DC]:NPLCycles <n>	Set NPLC for DCI
[[:SENSe[1]]]:VOLTage:AC:NPLCycles <n>	Set NPLC for ACV
[[:SENSe[1]]]:VOLTage[:DC]:NPLCycles <n>	Set NPLC for DCV
[[:SENSe[1]]]:RESistance:NPLCycles <n>	Set NPLC for Ω2
[[:SENSe[1]]]:FRESistance:NPLCycles <n>	Set NPLC for Ω4

Command Parameter:

<n> =	0.1 to 10	Set power line cycles per integration
	DEFault	1
	MINimum	0.1
	MAXimum	10

Query:

:NPLCycles? Query programmed NPLC value

Description:

The integration period (measurement speed) for the basic measurement functions (except Frequency and Period) is set using the:NPLCycles command. NPLC(Number of Power Line Cycles) expresses the integration period by basing it on the power line frequency. For example, for a PLC of 1, the integration period in seconds would be1/60 (for 60Hz line power) which is 16.67 msec.

:RANGe Commands

:[UPPer] <n>

Command syntax:

[::SENSe[1]]:CURRent:AC:RANGe:[UPPer] <n>	Set measurement range for ACI
[::SENSe[1]]:CURRent[:DC]:RANGe:[UPPer] <n>	Set measurement range for DCI
[::SENSe[1]]:VOLTage:AC:RANGe:[UPPer] <n>	Set measurement range for ACV
[::SENSe[1]]:VOLTage[:DC]:RANGe:[UPPer] <n>	Set measurement range for DCV
[::SENSe[1]]:RESistance:RANGe:[UPPer] <n>	Set measurement range for $\Omega 2$
[::SENSe[1]]:FRESistance:RANGe:[UPPer] <n>	Set measurement range for $\Omega 4$

Command Parameter:

<n> =	0 to 10	Expected reading is amps (ACI, DCI)
	0 to 757.5	Expected reading is AC volts (ACV)
	0 to 1010	Expected reading is DC volts (DCV)
	0 to 120e6	Expected reading is ohms ($\Omega 2$, $\Omega 4$)
	DEFault	10 (ACI and DCI) 757.5 (ACV) 1000 (DCV) 100e6 (Ω)
	MINimum	0 (All functions)
	MAXimum	Same as DEFault

Query:

:RANGe:[UPPer]? Query measurement range of the current functon.

Description:

This command is used to manually select the measurement range for the specified measurement function. The range is selected by specifying the expected reading as an absolute value. The instrument will then go to the most sensitive range that will accommodate that expected reading. For example, if you expect a reading of approximately 50mV, simply let the parameter (<n>) =0.05 (or 50e-3) in order to select the 100mV range.

:AUTO

Command syntax:

[::SENSe[1]]:CURRent:AC:RANGe:AUTO 	Set auto range for ACI
[::SENSe[1]]:CURRent[:DC]:RANGe:AUTO 	Set auto range for DCI
[::SENSe[1]]:VOLTage:AC:RANGe:AUTO 	Set auto range for ACV
[::SENSe[1]]:VOLTage[:DC]:RANGe:AUTO 	Set auto range for DCV
[::SENSe[1]]:RESistance:RANGe:AUTO 	Set auto range for $\Omega 2$
[::SENSe[1]]:FRESistance:RANGe:AUTO 	Set auto range for $\Omega 4$

Command parameter:

 =	1 or ON	Enable auto range
	0 or OFF	Disable auto range

Query:

:AUTO? Query auto range (ON or OFF)

Description:

These command are used to control auto ranging. With auto ranging enabled, the instrument automatically goes to the most sensitive range to perform the measurement.

The auto range command (:RANGe:AUTO) is coupled to the command that manually selects the measurement range (:RANGe <n>). When auto range is enabled, the parameter value for :RANGe <n> changes to the automatically selected range value. Thus, when auto range is disabled, the instrument remains at the automatically selected range. When a valid :RANGe <n> command is sent, auto ranging disables.

:REFerence <n> Commands

:REFerence <n>

Command syntax:

- | | |
|--------------------------------------|----------------------------|
| :SENSe[1]:CURRent:AC:REFerence <n> | Specify reference for ACI |
| :SENSe[1]:CURRent[:DC]:REFerence <n> | Specify reference for DCI |
| :SENSe[1]:VOLTage:AC:REFerence <n> | Specify reference for ACV |
| :SENSe[1]:VOLTage[:DC]:REFerence <n> | Specify reference for DCV |
| :SENSe[1]:RESistance:REFerence <n> | Specify reference for Ω2 |
| :SENSe[1]:FRESistance:REFerence <n> | Specify reference for Ω4 |
| :SENSe[1]:FREQUency:REFerence <n> | Specify reference for FREQ |
| :SENSe[1]:PERiod:REFerence <n> | Specify reference for PER |

Command parameter:

- | | |
|--------------------|--------------------------------------|
| <n> = -12 to 12 | Reference for ACI and DCI |
| -757.5 to 757.5 | Reference for ACV |
| -1010 to 1010 | Reference for DCV |
| 0 to 120e6 | Reference for Ω2 or Ω4 |
| 0 to 1.5e7 | Reference for FREQ |
| 0 to 1 | Reference for PER |
| DEFault | 0 (All measurement functions) |
| MINimum | Minimum value for specified function |
| MAXimum | Maximum value for specified function |

Query:

:REFerence? Query reference for relative function

Descripton:

These commands are used to establish a reference value for the specified function. When reference is enabled (:REFerence:STATe), the result will be the algebraic difference between the input signal and the reference value:

Reading = Input signal – Reference

From the front panel, reference is called relative (REL).

The :REFerence <n> command is coupled to the :ACQuire command. The last command sent (:REFerence <n> or :ACQuire) establishes the reference. When a reference is set using the :REFerence <n> command, the REFerence? Query command returns the programmed value. Conversely, when a reference is set using the :ACQuiry command, the :REFerence? Query command returns the acquired reference value.

**:STATe **

Command syntax:

[:SENSe[1]]:CURRent:AC:REFerence:STATe 	Control reference for ACI
[:SENSe[1]]:CURRent[:DC]:REFerence:STATe 	Control reference for DCI
[:SENSe[1]]:VOLTage:AC:REFerence:STATe 	Control reference for ACV
[:SENSe[1]]:VOLTage[:DC]:REFerence:STATe 	Control reference for DCV
[:SENSe[1]]:RESistance:REFerence:STATe 	Control reference for $\Omega 2$
[:SENSe[1]]:FRESistance:REFerence:STATe 	Control reference for $\Omega 4$
[:SENSe[1]]:FREQUency:REFerence:STATe 	Control reference for FREQ
[:SENSe[1]]:PERiod:REFerence:STATe 	Control reference for PER

Command parameter:

 =	1 or ON	Enable reference
	0 or OFF	Disable reference

Query:

:STATe? Query state of reference.

Description:

These commands are used to enable or disable Reference for the specified function. When enabled, the displayed reading will include the programmed reference value. When disabled, the displayed reading will not include the reference value.

:ACQuire

Command syntax:

[:SENSe[1]]:CURRent:AC:REFerence:ACQuire	Acquire reference for ACI
[:SENSe[1]]:CURRent[:DC]:REFerence:ACQuire	Acquire reference for DCI
[:SENSe[1]]:VOLTage:AC:REFerence:ACQuire	Acquire reference for ACV
[:SENSe[1]]:VOLTage[:DC]:REFerence:ACQuire	Acquire reference for DCV
[:SENSe[1]]:RESistance:REFerence:ACQuire	Acquire reference for $\Omega 2$
[:SENSe[1]]:FRESistance:REFerence:ACQuire	Acquire reference for $\Omega 4$
[:SENSe[1]]:FREQUency:REFerence:ACQuire	Acquire reference for FREQ
[:SENSe[1]]:PERiod:REFerence:ACQuire	Acquire reference for PER

Description:

When one of these commands is sent, the measurement input signal is acquired and established as the reference value. This command is typically used to zero the display. For example, if the instrument is displaying a 1µV offset, sending this command and enabling Reference zeroes the display.

This command is functional only if the instrument is on the specified measurement function. Sending this command while in any other function causes an error. Also, if the latest reading is overflowed or a reading has not been triggered, an error occurs when this command is sent.

:AVERage Commands

This command is used to configure and control the filter.

**:STATe **

Command syntax:

[:SENSe[1]]:CURRent:AC:AVERage:STATe 	Control filter for ACI
[:SENSe[1]]:CURRent[:DC]:AVERage:STATe 	Control filter for DCI
[:SENSe[1]]:VOLTage:AC:AVERage:STATe 	Control filter for ACV
[:SENSe[1]]:VOLTage[:DC]:AVERage:STATe 	Control filter for DCV
[:SENSe[1]]:RESistance:AVERage:STATe 	Control filter for Ω2
[:SENSe[1]]:FRESistance:AVERage:STATe 	Control filter for Ω4

Command parameter:

 = 1 or ON	Enable the digital filter
0 or OFF	Disable the digital filter

Query:

:STATe?	Query state of digital filter
---------	-------------------------------

Description:

These commands are used to enable or disable the digital filter for the specified function. When enabled, readings will be filtered according to how the filter is configured.

:TCONtrol <name>

Command syntax:

:CURRent:AC:AVERage:TCONtrol <name>	Select filter type for ACI
:CURRent[:DC]:AVERage:TCONtrol <name>	Select filter type for DCI
:VOLTage:AC:AVERage:TCONtrol <name>	Select filter type for ACV
:VOLTage[:DC]:AVERage:TCONtrol <name>	Select filter type for DCV
:RESistance:AVERage:TCONtrol <name>	Select filter type for Ω2
:FRESistance:AVERage:TCONtrol <name>	Select filter type for Ω4

Command parameter:

<name> =	REPeat	Select repeating filter
	MOVing	Select moving filter

Query:

:TCONtrol?	Query filter type
------------	-------------------

Description:

These commands are used to select the type of averaging filter for the specified function.

:COUNT <n>

Command syntax:

[[:SENSe[1]]:CURRent:AC:AVERage:COUNT <n>	Specify filter count for ACI
[[:SENSe[1]]:CURRent[:DC]:AVERage:COUNT <n>	Specify filter count for DCI
[[:SENSe[1]]:VOLTage:AC:AVERage:COUNT <n>	Specify filter count for ACV
[[:SENSe[1]]:VOLTage[:DC]:AVERage:COUNT <n>	Specify filter count for DCV
[[:SENSe[1]]:RESistance:AVERage:COUNT <n>	Specify filter count for $\Omega 2$
[[:SENSe[1]]:FRESistance:AVERage:COUNT <n>	Specify filter count for $\Omega 4$

Command parameter:

<n> =	1 to 100	Specify filter count
	DEFault	10
	MIMimum	1
	MAXimum	100

Query:

:COUNT?	Query filter count
---------	--------------------

Description:

These commands are used to specify the filter count. In general, the filter count is the number of readings that are acquired and stored in the filter buffer for the averaging calculation. The larger the filter count, the more filtering that is performed.

:THReshold Commands

Use these commands to set the maximum range input (signal level) for frequency and period measurements.

:RANGe <n>

Command syntax:

[[:SENSe[1]]:FREQUency:THReshold:VOLTage:RANGe <n>	Set voltage threshold range.
[[:SENSe[1]]:PERiod:THReshold:VOLTage:RANGe <n>	Set voltage threshold range.

Command parameter:

<n> = 0 to 1010 Specify signal levels in volts (voltage threshold)

Query:

:RANGe? Query maximum signal level.

Description:

These commands are used to specify the expected input level. The instrument will then automatically select the most sensitive current or voltage threshold range.

:DIODE Command

:RANGe[:UPPer] <NRf>

Command syntax:

[:SENSe[1]]:DIODE:CURRent:RANGe[:UPPer] <NRf> Specify current range for diode test

Command parameter:

<NRf> =	1 (1 mA)	Specify diode test current to 1mA
	10 (10µA)	Specify diode test current to 10µA
	100(100µA)	Specify diode test current to 100µA

Query:

[UPPer]? Query selected range

Description:

There are three current ranges available for the diode test: 10µA range, 100µA range and 1mA range. Range is selected by using this command to specify one of the above current range for the diode under test.

:CONTInuity Command

:THReshold <n>

Command Syntax:

[:SENSe[1]]:CONTInuity:THReshold <NRf>

Command parameter:

<NRf> = 1 to 1000 Specify threshold in ohms

Query:

:THReshold? Query threshold resistance

Description:

This command is used to specify the threshold resistance for the continuity test. Continuity occurs when the measurement is less than or equal to the specified threshold level.

6.3.5 SYSTem Subsystem

The SYSTem subsystem contains miscellaneous commands that are summarized in Table 6-5

Table 6-5 SYSTem Command Summary

Command	Function Description	Default
:SYSTem		
:PRESet	Return to system defaults	
:AZERo	Path to set up autozero	
:STATe 	Enable or disable autozero	ON
:STATe?	Query autozero	
:BEEPer	Path to control beeper	
[:STATe] 	Enable or disable beeper	ON
[:STATe]?	Query state of beeper	
:LOCal	Take multimeter out of remote and restore operation of front panel (RS232 only)	

:PRESet Command

:PRESet

Command Syntax:

:SYSTem:PRESet

Description:

This command returns the instrument to factory defaults states.

:AZERo Command

**:STATe **

Command Syntax:

:SYSTem:AZERo:STATe

Command parameter:

 = 1 or ON	Enable autozero
0 or OFF	Disable autozero

Query:

:STATe? Query state of autozero.

Description:

This command is used to enable or disable autozero. When enabled, accuracy is optimized. When disabled, speed is increased at the expense of accuracy.

Important Note: Before you can enable or disable autozero, Model Th1951 must first be in the idle state.

:BEEPer Command

**[:STATe] **

Command Syntax:

:SYSTem:BEEPer[:STATe]

Command Parameter:

 =	1 or ON	Enable beeper
	0 or OFF	Disable beeper

Query:

[:STATe]? Query state of beeper

Description:

This command is used to enable or disable the beeper for limit tests.

RS-232 Interface Commands

:LOCal

Command syntax:

:SYSTem:LOCal

Description:

This command is used to take Model TH1951 out of the remote state and enable the operation of the front panel.

6.3.6 UNIT Subsystem

The UNIT subsystem is used to configure and control the measurement units for ACV, and DCV, and is summarized in Table 6-6.

Table 6-6 UNIT Command Summary

Command	Function description	Default
:UNIT		
:VOLTage	Path to configure voltage unit	
:AC <name>	Select ACV measurement units (V, DB or DBM)	V
:DB	Path to set DB reference voltage	
:REFerence <n>	Specify reference in volts (1e-7 to 1000)	1
:REFerence?	Query DB reference	
:DBM	Path to set DBM reference impedance	
:IMPedance <n>	Specify reference impedance (1 to 9999)	75
:IMPedance?	Query DBM reference impedance	
:AC?	Query ACV units	
[:DC] <name>	Select DCV measurement units(V, DB, DBM)	V
:DB	Path to set DB reference voltage:	
:REFerence <n>	Specify reference in volts (0 to 1000)	1
:REFerence?	Query DB reference voltage	
:DBM	Path to set DBM reference impedance:	
:IMPedance <n>	Specify reference impedance(1e-7 to 1000)	75
:IMPedance?	Query DBM reference impedance	
[:DC]?	Query DCV units	

:VOLTage Command

:AC <name>

Command Syntax:

:UNIT:VOLTage:AC <name>

Command parameter:

<name> =	V	AC voltage measurement units
	DB	dB AC voltage measurement units
	DBM	dBm AC voltage measurement units

Query:

:VOLTage:AC? Query AC voltage units

Description:

The command is used to select the units for ACV measurement. With volt (V) units selected, normal AC voltage measurement are made for the ACV function. With DB units selected, AC dB voltage measurements are performed. The DBM units selection is used to make decibel measurements referenced to 1mW.

:DB:REFeRence <n>

Command Syntax:

:UNIT:VOLTage:AC:DB:REFeRence <n>

Command Parameter:

<n> = 1e-7 to 1000 Specify reference voltage

Query:

:DB:REFeRence? Query reference voltage

Description:

This command is used to specify the dB reference level. When DB units is selected, ACV dB measurements are made using the specified dB reference impedance.

The reference level is specified in volts and is not range dependent. For example: a dB reference level of 1 is 1V on all ACV measurement ranges.

:DBM:IMPedance <n>

Command Syntax:

:UNIT:VOLTage:AC:DBM:IMPedance <n>

Command parameter:

<n> = 1~9999 Specify reference impedance

Query:

:DBM:IMPedance? Query reference impedance.

Description:

This command is used to specify the dBm reference impedance level. When dBm units is selected, ACV dBm measurements are made using the specified dBm reference impedance.

The reference impedance is specified in ohms and is not range dependent. For Example: a dBm reference level of 500 is 500 on all ACV measurement ranges. A rational number is rounded to the nearest valid integer value.

:VOLTage[:DC] <name>

Command Syntax:

:UNIT:VOLTage:DC <name>

Command Parameter:

<name> =	V	DC voltage measurement units
	DB	dB DC voltage measurement units
	DBM	dBm DC voltage measurement units

Query:

:VOLTage:DC? Query DC voltage units

Description:

This command is used to select the units for DCV measurements. With volt (V) units selected, normal DC voltage measurements are made for the DCV function. With DB units selected, DC dB voltage measurements are performed. The DBM units selection is used to make decibel measurements referenced to 1mW.

:DB:REFerence <n>

Command Syntax:

:UNIT:VOLTage:DC:DB:REFerence <n>

Command parameter:

<n> = 1e-7 to 1000 Specify reference voltage in volts

Query:

:DB:REFerence? Query reference voltage

Description:

This command is used to specify the dB reference level. The DB unit is selected, DCV dB measurements are made using the specified dB reference level.

The reference level is specified in volts and is not range dependent. For example: a dB reference level of 1 is 1V on all DCV measurement ranges.

:DBM:IMPedance <n>

Command Syntax:

:UNIT:VOLTage:DC:DBM:IMPedance <n>

Command Parameter:

<n> = 1~9999 Specify reference impedance

Query:

:DBM:IMPedance? Query reference impedance

Description:

This command is used to specify the dBm reference impedance level. When dBm units is selected, DCV dBm measurements are made using the specified dBm reference impedance.

The reference impedance is specified in ohms and is not range dependent. For Example: a dBm reference level of 500 is 500 on all DCV measurement ranges. A rational number is rounded to the nearest valid integer value.

6.3.7 TRIGger Subsystem

The Trigger subsystem is made up of a series of commands and subsystems to configure the Trigger model. These commands and subsystems are summarized in Table 6-7

Table 6-7 TRIGger Command Summary

Command	Function Description	Default
:INITiate [:IMMEDIATE]	Subsystem command path Initiate one trigger cycle.	
:CONTInuous 	Enable or disable continuous initiation.	
:CONTInuous?	Query continuous initiation.	
:ABORt	Reset trigger system	
:TRIGger		
:SOURce <name>	Select control source	IMMEDIATE
:SOURce?	Query control source	
:DELay <n>	Set delay time	0
:AUTO 	Enable or disable auto delay	OFF
:AUTO?	Query state of delay	
:DELay?	Query delay	
:COUNt <n>	Set measure count	infinite
:COUNt?	Query measure count	
:SAMPlE		
:COUNt <NRf>	Specify sample count	1
:COUNt?	Query sample count	

:INITiate commands

[:IMMEDIATE]

Command Syntax:

:INITiate[:IMMEDIATE]

Description:

This command takes the Model th1951 out of the idle state. After all programmed operations are completed, the instrument returns to the idle state if continuous initiation is disabled; (see next command).

:CONTInuous

Command Syntax:

:INITiate:CONTInuous Control continuous initiation

Command parameter:

 = 0 or OFF Disable continuous initiation
 1 or ON Enable continuous initiation

Query:

:CONTInuous? Query continuous initiation

Description:

When continuous initiation is selected (ON), the instrument is taken out of the idle state. At the conclusion of all programmed operations, the instrument returns to the top of the trigger model.

NOTE: *With continuous initiation enabled (ON), you cannot use the :READ? command or set sample count greater than one (see:SAMPlE:COUNT).*

:ABORt Command

:ABORt

Description:

When this action command is sent, Model TH1951 aborts operation and returns to the top of the Trigger Model.

:TRIGger

TRIGger subsystem commands are used for the instrument settings of trigger mode, trigger delay and trigger a measurement.

:SOURce <name>

Command Syntax:

TRIGger:SOURce <name>

Command parameter:

<name> =	IMMEDIATE	instrument default setting is internal trigger)
	BUS	Triggered via RS232 interface of GPIB interface)
	MANual(EXTernal)	(Press <input type="button" value="Trig"/> in the front panel for Trigger)

Query:

:SOURce? Query control source)

Description:

These are used to select the event control source.

:DELay <n>

Command Syntax:

:TRIGger:DELay <n>

Command parameter:

<n> =	0 to 60000	Specify delay in
	MINimum	Specify delay of 0S
	MAXimum	Specify delay of 60S

Query:

:DELay? Query the programmed delay

Description:

This command is used for delay operation of the trigger model. The delay time can also be set by using the AUTO parameter and this value is stored in the volatile memory.

**:AUTO **

Command Syntax:

:TRIGger:DELay:AUTO

Command parameter:

 =	1 or ON	Enable atuo delay
	0 or OFF	Disable atuo delay

Query:

:AUTO? Query delay state

Description:

This command is used for enable or disable auto delay state at trigger model.

:COUNT <n>

Command Syntax:

:TRIGger:COUNT <n>

Command parameter:

<n> =	1 to 9999	Set trigger count
	INFinite	Set trigger count of infinite
	MINimum	Set trigger count of 1
	MAXimum	Set trigger count of 9999

Query:

COUNT? Query trigger count

Description:

Specify the trigger count before the multimeter go back to idle. Parameter INFinite indicates the multimeter can receive trigger continuously. When the instrument is at local control, the trigger count is ignored. The reference value is saved in the volatile memory.

:SAMPLE

:COUNT <NRf>

Command Syntax:

:SAMPle:COUNT <NRf>

Command parameter:

<NRf> =	1 to 512	Set sample count
	MINimum	Set sample count of 1
	MAXimum	Set sample count of 512

Query:

:SAMPle?

Description:

Set sample count of every trigger. The reference value is saved in the volatile memory.

6.3.8 R Subsystem

:R?

Description:

The R subsystem is use to read the measurement results stored in the memory.

6.3.9 Common Commands

Common commands can be used to all equipments. We provide some common commands as below:

***RST**

Command Syntax:

*RST

Description:

Reset the instrument

***TRG**

Command Syntax:

*TRG

Description:

Trigger the instrument for measurement

***IDN?**

Query Syntax:

*IDN?

Query return:

<product>,<version><LF^END>

Here:

<product> TH1951 Digital Multimeter

<version> Ver1.0

Description:

Query information returned to instrument

Chapter 7 Specifications

A-1 Introduction

Chapter 7 describes the complete specifications of the Model TH1951 Multimeter.

A-2 Technical Specifications

Specifications Assumptions

- One year calibration cycle.
- Operating temperature at 18°C to 28°C
- Accuracy is expressed as: $\pm(\% \text{ of reading} + \% \text{ of range})$ after 30 minutes' warm-up.
- Temperature Coefficient: add $\pm [0.1\% \times (\text{the applicable accuracy})/^\circ\text{C}]$ for 0°C to 18°C and 28°C to 40°C;
- Relative Humidity: Up to 80% for 0°C to 28°C (75% RH for 10M Ω and above ranges of resistance measurement). Up to 70 for 28°C to 40°C.

Displayed Readings and Reading rates

Full Scale displayed reading

Slow	Med	Fast
119,999	119,999	11,999

Reading rates on front panel (Reading/sec, Approximate)

Measurement Function	Slow	Med	Fast
DCV	4	16	57
DCA	4	16	57
ACV	3	4	25
ACA	3	4	25
2-Wire Ω (Ranges below 100k Ω)	4	16	57
2-Wire Ω (100k Ω range and above)	4	16	25
4-Wire Ω (Ranges below 100k Ω)	3	10	33
4-Wire Ω (100k Ω range and above)	3	10	20
Freq	1	————	————
Period	1	————	————
Diode	————	16	————
Continuity	————	————	57

DC CHARACTERISTICS

CONDITIONS: SLOW or MED with filter of 10

ACCURACY: \pm (% of reading + % of range)

- DC Voltage

Resolution, Full Scale reading and Accuracy

Rate	Range	Resolution	Typical Input Impedance	Accuracy (1 year)	Full Scale Reading
Slow	100.000mV	1 μ V	>10G	0.02%+8 ⁽¹⁾	119.999
	1.00000 V	10 μ V	>10G	0.01%+4 ⁽¹⁾	1.19999
	10.0000 V	100 μ V	>10G	0.01%+4	11.9999
	100.000 V	1 mV	10M \pm 1%	0.01%+4	119.999
	1000.00 V	10 mV	10M \pm 1%	0.01%+4	1010.00 ⁽²⁾
Med	100.000mV	1 μ V	>10G	0.02%+15 ⁽¹⁾	119.999
	1.00000 V	10 μ V	>10G	0.01%+8 ⁽¹⁾	1.19999
	10.0000 V	100 μ V	>10G	0.01%+8	11.9999
	100.000 V	1 mV	10M \pm 1%	0.01%+8	119.999
	1000.00 V	10 mV	10M \pm 1%	0.01%+8	1010.00 ⁽²⁾
Fast	100.00mV	10 μ V	>10G	0.02%+4 ⁽¹⁾	119.99
	1.0000 V	100 μ V	>10G	0.02%+2 ⁽¹⁾	1.1999
	10.000 V	1 mV	>10G	0.02%+2	11.999
	100.00 V	10 mV	10M \pm 1%	0.02%+2	119.99
	1000.0 V	100 mV	10M \pm 1%	0.02%+2	1010.0 ⁽²⁾
⁽¹⁾ under REL status					
⁽²⁾ 1% over-range (1010V) is readable at 1000V range					

Maximum input voltage: 1000VDC or peak ac for all ranges.

● Resistance (2-Wire and 4-Wire)

Speed	Range ⁽¹⁾	Resolution	Full scale reading	Test current	Accuracy (1Year)
Slow	100.000 Ω	1m Ω	119.999	1 mA	0.05%+8 ⁽²⁾
	1.00000 k Ω	10m Ω	1.19999	1 mA	0.03%+4 ⁽²⁾
	10.0000 k Ω	100m Ω	11.9999	100μA	0.03%+4 ⁽²⁾
	100.000 k Ω	1 Ω	119.999	10μA	0.03%+4
	1.00000 M Ω	10 Ω	1.19999	10μA	0.03%+4
	10.0000 M Ω	100 Ω	11.9999	7.0*R _x / (10M+R _x)	0.1%+4
	100.000 M Ω	1 k Ω	119.999	7.0*R _x / (10M+R _x)	1.0%+8
	1.00000 M Ω				
	10.0000 M Ω				
Med	100.000 Ω	1m Ω	119.999	1 mA	0.05%+15 ⁽²⁾
	1.00000 k Ω	10m Ω	1.19999	1 mA	0.03%+8 ⁽²⁾
	10.0000 k Ω	100m Ω	11.9999	100μA	0.03%+8 ⁽²⁾
	100.000 k Ω	1 Ω	119.999	10μA	0.03%+8
	1.00000 M Ω	10 Ω	1.19999	10μA	0.03%+8
	10.0000 M Ω	100 Ω	11.9999	7.0*R _x / (10M+R _x)	0.1%+8
	100.000 M Ω	1 k Ω	119.999	7.0*R _x / (10M+R _x)	1.2%+15
	1.00000 M Ω				
	10.0000 M Ω				
Fast	100.00 Ω	10m Ω	119.99	1 mA	0.05%+2 ⁽²⁾
	1.0000 k Ω	100m Ω	1.1999	1 mA	0.03%+2 ⁽²⁾
	10.000 k Ω	1 Ω	11.999	100μA	0.03%+2 ⁽²⁾
	100.00 k Ω	10 Ω	119.99	10μA	0.03%+2
	1.0000 M Ω	100 Ω	1.1999	10μA	0.05%+2
	10.000 M Ω	1 k Ω	11.999	7.0*R _x / (10M+R _x)	0.1%+2
	100.00 M Ω	10 k Ω	119.99	7.0*R _x / (10M+R _x)	1.2%+2
<p>⁽¹⁾ In order to eliminate the noise interference, which might be induced to the test leads, it is recommended to use a shielded test cable for measuring resistance above 100kΩ.</p> <p>⁽²⁾ Using REL function</p>					

Maximum Input Protection: 1000VDC or 750VAC for all ranges.

Open circuit voltage: Maximum voltage is 13.3V dc for 100Ω, 1kΩ, 10Ω, 10MΩ and 100MΩ ranges;

Maximum voltage is 7V dc for 100kΩ and 1M ranges.

● **DC Current**

Speed	Range	Resolution	Full scale reading	Accuracy (1Year)	Burden Voltage ⁽¹⁾ & Shunt Resistor
Slow	10.0000mA	0.1 μ A	11.9999	0.05%+8 ⁽²⁾	<0.15V / 10.1 Ω
	100.000mA	1 μ A	119.999	0.05%+4 ⁽²⁾	<1.5V / 10.1 Ω
	1.00000 A	10 μ A	1.19999	0.10%+4	<0.3V / 0.1 Ω
	10.0000 A	100 μ A	11.9999	0.25%+4	<0.15V / 10m Ω
Med	10.0000mA	0.1 μ A	11.9999	0.05%+15 ⁽²⁾	<0.15V / 10.1 Ω
	100.000mA	1 μ A	119.999	0.05%+8 ⁽²⁾	<1.5V / 10.1 Ω
	1.00000 A	10 μ A	1.19999	0.10%+8	<0.3V / 0.1 Ω
	10.0000 A	100 μ A	11.9999	0.25%+8	<0.15V / 10m Ω
Fast	10.000mA	1 μ A	11.999	0.1%+2 ⁽²⁾	<0.15V / 10.1 Ω
	100.00mA	10 μ A	119.99	0.1%+2 ⁽²⁾	<1.5V / 10.1 Ω
	1.0000 A	100 μ A	1.1999	0.1%+2	<0.3V / 0.1 Ω
	10.000 A	1 mA	11.999	0.25%+2	<0.15V / 10m Ω
⁽¹⁾ Typical voltage across the input terminals at full scale reading. ⁽²⁾ Use REL function					

Input protection: 2A,250V Fuse

At range of 10A, when testing larger current, the test time should not be over 20s.

Continuity

Rate	Range	Resolution	Full Scale Reading	Test Current	Accuracy (1 year)
Fast	1 k Ω	100m Ω	999.9	1mA	0.10+20

Maximum Input Protection: 1000VDC or 750VAC for all ranges.

Open circuit voltage: <13.3V DC

Test Current: around 1mA DC

Threshold resistance: From 1 Ω to 1000 Ω , default of power on is 10 Ω

Diode

Rate	Range	Resolution	Full Scale Reading	Test Current
Med	3.0000 V	100 μ V	2.9999	1 mA
	10.0000 V	100 μ V	10.0000	100 μ A
	10.0000 V	100 μ V	10.0000	10 μ A

Maximum Input Protection: 1000VDC or 750VAC for all ranges.

TRUE RMS AC VOLTAGE AND CURRENT CHARACTERISTICS

ACCURACY: \pm (% of reading + % of range), 23°C \pm 5°C。

● AC Voltage

Resolution and Full Scale Reading

Range	Resolution		Full Scale Reading	
	Slow & Med	Fast	Slow & Med	Fast
100.000 mV	1 μ V	10 μ V	119,999	119.99
1.00000 V	10 μ V	100 μ V	1.19999	1.1999
10.0000 V	100 μ V	1 mV	11.9999	11.999
100.000 V	1 mV	10 mV	119.999	119.99
750.00 V	10 mV	100 mV	757.50 ⁽¹⁾	757.5 ⁽¹⁾

⁽¹⁾ 1% over- range (757.5V) is readable at 750V range.

Accuracy

Speed	Range	Accuracy (1Year) ⁽¹⁾				
		10~20 Hz	20~50 Hz	50~20 kHz	20~50 kHz	50~100 kHz
Slow	100.000 mV	1.5%+100	0.5%+100	0.1%+100	0.3%+150	1%+150
	1.00000 V	1.5%+100	0.5%+100	0.1%+100	0.3%+100	1%+100
	10.0000 V	1.5%+100	0.5%+100	0.1%+100	0.3%+100	1%+100
	100.000 V	1.5%+100	0.5%+100	0.1%+100	0.3%+100	1%+100
	750.00 V	1.5%+100	0.5%+100	0.1%+100	0.3%+100 ⁽²⁾	1%+100 ⁽¹⁾
Med	100.000 mV	1.5%+200	0.5%+200	0.1%+200	0.3%+300	1%+300
	1.00000 V	1.5%+150	0.5%+150	0.1%+150	0.3%+200	1%+200
	10.0000 V	1.5%+150	0.5%+150	0.1%+150	0.3%+200	1%+200
	100.000 V	1.5%+150	0.5%+150	0.1%+150	0.3%+200	1%+200
	750.00 V	1.5%+150	0.5%+150	0.1%+150	0.3%+200 ⁽²⁾	1%+200 ⁽¹⁾
Fast	100.00 mV		1.5%+30	0.2%+30	0.5%+35	1.5%+30
	1.0000 V		1.5%+20	0.2%+20	0.5%+25	1.5%+20
	10.000 V		1.5%+20	0.2%+20	0.5%+25	1.5%+20
	100.00 V		1.5%+20	0.2%+20	0.5%+25	1.5%+20
	750.0 V		1.5%+20	0.2%+20	0.5%+25 ⁽²⁾	1.5%+20 ⁽¹⁾

(1) Accuracy is in (SLOW), input sine wave with the range > 5%.
(2) In the range of 750VAC, limited in 40kHz or 3 \times 10⁷ Volt-Hz

Measurement method: True RMS measurement

Maximum Crest factor: 3.0 at full scale

Maximum input voltage: 750Vrms

$\leq 3 \times 10^7$ Volt-Hz for all ranges

Input impedance: 1M Ω \pm 2% in parallel with capacitance <100pF

Maximum DCV: 500V for all AC ranges

- AC Current (True RMS, AC Coupling)

Resolution and Full Scale Reading

Rate	Range	Resolution	Full Scale Reading	Burden Voltage ⁽¹⁾ & Shunt Resistor
Slow	10.0000mA	0.1 μA	11.9999	<0.15V / 10.1Ω
	1.00000 A	10μA	1.19999	<0.3V / 0.1Ω
	10.0000 A	100μA	11.9999	<0.15V / 10mΩ
Med	10.0000mA	0.1 μA	11.9999	<0.15V / 10.1Ω
	1.00000 A	10μA	1.19999	<0.3V / 0.1Ω
	10.0000 A	100μA	11.9999	<0.15V / 10mΩ
Fast	10.000mA	1 μA	11.999	<0.15V / 10.1Ω
	1.0000 A	10μA	1.1999	<0.3V / 0.1Ω
	10.000 A	1mA	11.999	<0.15V / 10mΩ

⁽¹⁾ If the test frequency is over 1MHz, the instrument can display without indicated accuracy.
⁽²⁾ Sine wave with the indicated accuracy>5%

Accuracy

Rate	Range	Accuracy (1 year) ⁽¹⁾			
		10~20 Hz	20~50 Hz	50~2 kHz	2~10 kHz
Slow	10.0000mA	1%+80	0.5%+80	0.25%+80	2%+80
	1.00000 A	1%+80	0.5%+80	0.25%+80	2%+80
	10.0000 A	-----	0.5%+80	0.30%+80	-----
Med	10.0000mA	1%+150	0.5%+150	0.25%+150	2%+150
	1.00000 A	1%+150	0.5%+150	0.25%+150	2%+150
	10.0000 A	-----	0.5%+150	0.30%+150	-----
Fast	10.000mA		1%+20	0.5%+10	3%+10
	1.0000 A		1%+20	0.5%+10	3%+10
	10.000 A		1%+20	0.5%+10	-----

⁽¹⁾ Specified accuracy at input >5% of the range

Measurement method: True RMS measurement

Maximum Crest factor: 3.0 at full scale

Maximum Input and Overload Current Protection: 2A/ 250V fuse.

FREQUENCY AND PERIOD CHARACTERISTICS

CONDITIONS: SLOW RATE (GATE TIME 1 Sec)

ACCURACY: \pm (% of Reading)

● Frequency

ACV Range	Frequency Range	Gate Time	Resolution	Full Scale Reading	Accuracy ⁽²⁾	Input Sensitivity (Sine Wave)
100mV to 750V	5 to 10 Hz	1 s (Slow)	10 μ Hz	9.99999	0.05%+100	200mVrms
	10 to 100Hz		100 μ Hz	99.9999	0.01%+10	40mVrms
	100 to 100 kHz		1mHz	999.999	0.005%+2	40mVrms
	100k to 1MHz ⁽¹⁾		1 Hz	999.999	0.005%+2	100mVrms

Maximum Crest factor: 3.0 at full scale

Maximum input voltage: 750Vrms

$\leq 3 \times 10^7$ Volt-Hz for all ranges

Input impedance: 1M Ω \pm 2% in parallel with capacitance <100pF

Maximum DCV: 500V for all AC ranges

● Period

ACV Range	Period Range	Gate Time	Resolution	Full Scale Reading	Accuracy ⁽²⁾	Input Sensitivity (Sine Wave)
100mV to 750V	1~10 μ s ⁽¹⁾	1 s (Slow)	0.01ns	9.99999	0.005%+2	100mVrms
	10 μ s~10ms		0.1ns	9.99999	0.005%+2	40mVrms
	10ms~100ms		0.1 μ s	99.9999	0.01%+10	40mVrms
	100ms~200ms		1 μ s	199.999	0.05%+100	200mVrms

Maximum Crest factor: 3.0 at full scale

Maximum input voltage: 750Vrms

$\leq 3 \times 10^7$ Volt-Hz for all ranges

Input impedance: 1M Ω \pm 2% in parallel with capacitance <100pF

Maximum DCV: 500V for all AC ranges

Measure Characteristics

Gate Time: 1 sec.

(1) If tested frequency is greater than 1MHz, it will be displayed but no specified accuracy is guaranteed

(2) Specified accuracy at input >5% of range.

Measuring rate

Maximum rate under internal trigger mode: 1000 meas/sec

Maximum rate under external trigger mode: 1000 meas/sec (measurement results are stored in the internal memory)

Triggering and Memory

Reading hold sensitivity: 0.01%, 0.1%, 1% or 10% of reading

Sampling number after each trigger: 1~30000

Trigger Delay: 0 to 6000ms (1 ms step size)

Memory: 512 readings can be stored

Math Functions

Rel, Max/Min/Average/StdDev (of stored reading), dBm, dB, Limit Test, % and $mX+b$

dBm Reference Resistance: 1Ω to 9999Ω (1Ω step size), default is 75Ω

Standard Programming Languages

SCPI (Standard Commands for Programmable Instruments)

Remote Interface

GPIOB(IEEE-488.2), USB and RS-232C

General Specifications

Power Supply: $110/220V\pm 10\%$

Power Line Frequency: $50/60\text{Hz} \pm 5\%$

Power Consumption: $\leq 20\text{VA}$

Operating Environment: 0°C to 40°C , $\leq 90\%RH$,

Storage Environment: -40°C to 70°C

Warm-up: more than 30mins

Dimensions (W×H×D): $225\text{mm}\times 100\text{mm}\times 355\text{mm}$

Net Weight: Around 2.5Kg

Warranty: 2 years

Chapter 8 Program Examples

Serial Interface Program

The following example is a communication program. It is programmed with C Language and working in DOS environment. Where the MAIN Function could be extended for communication functions by users and other sub functions show you how to input and output character strings using serial interfaces.

```
#define PORT 0
#include "dos.h"
#include "stdio.h"
#include "stdlib.h"
#include "ctype.h"
#include "string.h"
#include "conio.h"

void port_init( int port,unsigned char code );
int check_stat( int port );          /* read serial port state(16bit) */
void send_port( int port,char c );  /* send a character to serial port */
char read_port( int port );         /* receive a character form serial port */

void string_wr( char *ps );         /* write a string to serial port */
void string_rd( char *ps );         /* read a string from serial port */

char input[256];                    /* query receive buffer */

main()
{ port_init( PORT,0xe3 );/* initialize serial port:baud = 9600,no verify,1 bit stop,8 bit data */
  string_wr( "trig:sour bus;*trg" );
  string_rd( input );
  printf( "\n%s",input );

  string_wr( "volt:dc:rang 1.0" );
  string_wr( "func 'volt:ac' );
}

/* write string to serial port */
void string_wr( char *ps )
{ char c;
  int m,n;
  while( check_stat(PORT) & 256) read_port(PORT);/* read data until null */
  for( ;*ps; )
```

```

{ c = 0;
  for( m = 100;m;m-- )
  { send_port( PORT,*ps );
    for( n = 1000;n;n-- )
    { delay(2); /* wait about 2ms,can use dos.h libray funtion:delay */
      if( kbhit() && ( getch() == 27 ) ) /* if escape key keypress */
      { printf( "\nE20:Serial Port Write Canceled!" );
        exit(1);
      }
      if( check_stat(PORT) & 256 )
      { c = read_port( PORT );
        break;
      }
    }
  }
  if( n ) break;
}
if( c == *ps ) ps++;
else
{ printf( "\nE10:Serial Port Write Echo Error!" );
  exit(1);
}
}
send_port( PORT,'\n' );/* send command end symbol */
delay( 2 );
while( !(check_stat(PORT) & 256) );
read_port( PORT );
}

```

```

/* read string from serial port */
void string_rd( char *ps )
{ unsigned char c,i;
  for( i = 0;i < 255;i++ ) /* max read 256 characters */
  { while( ! (check_stat(PORT) & 256) ) /* wait serial receive ready */
    if( kbhit() && ( getch() == 27 ) ) /* if escape key keypress */
    { printf( "\nE21:Serial Port Read Canceled!" );
      exit(1);
    }
    c = read_port( PORT );
    if( c == '\n' ) break;
    *ps = c;
    ps++;
  }
  *ps = 0;
}

```

```

/* send a character to serial port */
void send_port( int port,char c )
{ union REGS r;
  r.x.dx = port;          /* serial port */
  r.h.ah = 1;             /* int14 function1: send character */
  r.h.al = c;             /* character to be sent */
  int86( 0x14,&r,&r );
  if( r.h.ah & 128 ) /* check ah.7,if set by int86( 0x14,&r,&r ),mean trans error */
  { printf( "\nE00:Serial port send error!" );
    exit(1);
  }
}

/* read a character from serial port */
char read_port( int port )
{ union REGS r;
  r.x.dx = port;          /* serial port */
  r.h.ah = 2;             /* int14 function2:read character */
  int86( 0x14,&r,&r );
  if( r.h.ah & 128 ) /* if ah.7 be set, mean trans error */
  { printf( "\nE01:Serial port read error!" );
    exit(1);
  }
  return r.h.al;
}

/* check the status of serial port */
int check_stat( int port )
{ union REGS r;
  r.x.dx = port;          /* serial port */
  r.h.ah = 3;             /* int14 function3:read status */
  int86( 0x14,&r,&r );
  return r.x.ax;          /* ax.7 show serial operation, ax.8 show serial receive ready */
}

/* initialize the serial port */
void port_init( int port, unsigned char code )
{ union REGS r;
  r.x.dx = port;          /* serial port */
  r.h.ah = 0;             /* int14 function0:initial serial port */
  r.h.al = code;          /* initialization code */
  int86( 0x14,&r,&r );
}

```

Chapter 9 Error Messages

Number	Description
ERR:-100	Ram self check failed
ERR:-200	DCV Calibrate Data is lost
ERR:-201	DCV Short Data is lost
ERR:-210	ACV Calibrate Data is lost
ERR:-211	ACV Short Data is lost
ERR:-220	DCI Calibrate Data is lost
ERR:-221	DCI open Data is lost.
ERR:-230	ACI Calibrate Data is lost
ERR:-231	ACI short data is lost
ERR:-240	R2 Calibrate Data is lost
ERR:-241	R2 short Data is lost
ERR:-250	R4 Calibrate Data is lost
ERR:-251	R4 short data is lost
ERR:-260	Eeprom cannot Write.
ERR:-300	Adc No Unk
ERR:-301	Adc No End
ERR:-303	Adc No Count