

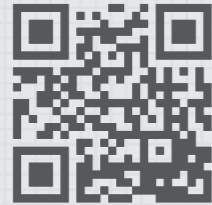

Our Service
Your Choice



Website



VR



Product Catalogue 2022 V20

*LED lighting
since 2009*

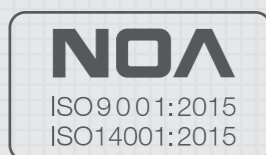

Shenzhen Toppo Lighting Company Limited
Toppo Lighting(Hui Zhou) Company Limited
Tel:86-755-84296868 86-755-84296818 Fax:86-755-84296866
E-mail: info@toppolighting.com Marketing : inquiry@toppolighting.com
Website:www.toppolighting.com www.toppoledlighting.com

*Our Service, Your Choice
Our People, Here for you*

COMPANY

Introduction

Toppo Lighting is one of the professional manufacturers which specialized in developing, production and selling on LED lighting. The company was established in 2009. Under the development in these years, we have grown into a headquarters and divisional type of modern enterprise. The headquarters is located in Shenzhen and independent industrial park in Huizhou, with a total production area of more than 20,000 square meters.

As a worldwide LED Lighting manufacturer, our product range includes the industrial lighting, commercial lighting, office lighting, education lighting, residential lighting and outdoor lighting. The product series include Linear lights, Panel lights, Ceiling lights, down lights, Highbay lights, Roadway lights, Post top and bollard lights, Gas station lights, Etc.

In order to keep us at the forefront of marketing, technology and product, we not only have the prominent team on sales and R&D, but also, we build professional laboratory. We can do various of testings which include: EMI/EMF testing, Surge testing, ESD testing, IES testing, Global lighting testing, Temperature recycle testing, Fire rate testing, IP testing, Drop testing, Salt spray test, etc. It makes us obtained good reputation from the worldwide customers under the above prominent team and professional laboratory.

"Customer is the first, Quality is priority" is our business philosophy. In order to ensure high effective operation and management, we not only use the ISO9001:2015 quality system and ISO14001:2015 environmental system as the basic management system, but also, we use the modern IT technology system to guarantee the operation of each procedures. The IT system includes the below modules: HR/OA/CRM/PLM/ERP/SRM/WMS/MESS/AC. The management system and IT platform make us achieve an excellent benefits from above each module. On the base of the above management system, we use the modern automatic product and aging testing machine on the production to insure the quality and delivery to customers. We have several numbers of automatic production line, aging testing line and SMT workshop. It makes our monthly production capacity achieve more than 300,000pcs.

Our products are worldwide popular. All of the products have got the various of certifications, such as: UL /ETL/FCC/DLC/TUV-GS/TUV-CE/ SAA/UKCA/ROHS/CB, etc. Under the growing on these years, our company also obtained various of license from the government, such as: "HI-TECH" enterprise, "S-R-D-I" enterprise, "china famous brand" enterprise, etc.

"Character, Quality, Grade, Brand" as the core values of Toppo lighting, we always keep the "Talents are the first" concept to build our team. We always adhere to the core cultural concept of "organization for people, process for work, performance for value" and strive to build the company into a fertile land of "happy work, happy live" for all staff, so as to provide more opportunities for all staff's personal career growth and life goals.

We will always adhere "Saving energy as we can, Brighten the word as possible" corporate vision, to design and produce high quality led light to bright your future modern life.



2009-2011

- Established in 2009, Finished the product & marketing
- 1st factory got LED tube design patent
- 1st factory got LED tube VDE / TUV / ETL / FCC license
- Built ISO9001:2008 / ISO14001:2008 and ERP management system
- 1st relocation in Mar.2011

2012-2014

- Built dust-free work shop / automatic assembly & aging line
- Built cooperation with European distributor
- Built the engineer laboratory
- Built UL and GS product series, Finished market Segment

2015-2017

- Relocation in Mar.2017
- Built new ERP system, Improved management efficiency
- Upgrade company team focus on Sales / Operation / R&D system
- Built oversea sales more distributor

2018-2020

- Built the auto-matic assembly line and upgrade the workshop
- Start the innovation of internal operation /HR management
- Upgrade the technology system to focus on different R&D team

2021-2022

- Built the own industrial park more than 20,000 square meters
- Built the new north american distributor
- Build new management system include: OA/PLM/CRM/WMS/MESS/SRM/ ERP
- Build the painting factory as a supply chain
- Upgrade the management team for 2023-2026 business strategy

2023-

- Setup new sale and marketing centre on shenzhen downtown
- Move the production to own industrial park
- Build the metal stamping and plastic injection supply chain
- Make the innovation on management team for 2023-2026 business strategy

We Focus on

SAVING ENERGY AS WE CAN,
BRIGHTEN THE WORD AS POSSIBLE.

INDUSTRIAL LIGHTING

COMMERCIAL LIGHTING

OFFICE LIGHTING

EDUCATION LIGHTING

RESIDENTIAL LIGHTING

Outdoor LIGHTING

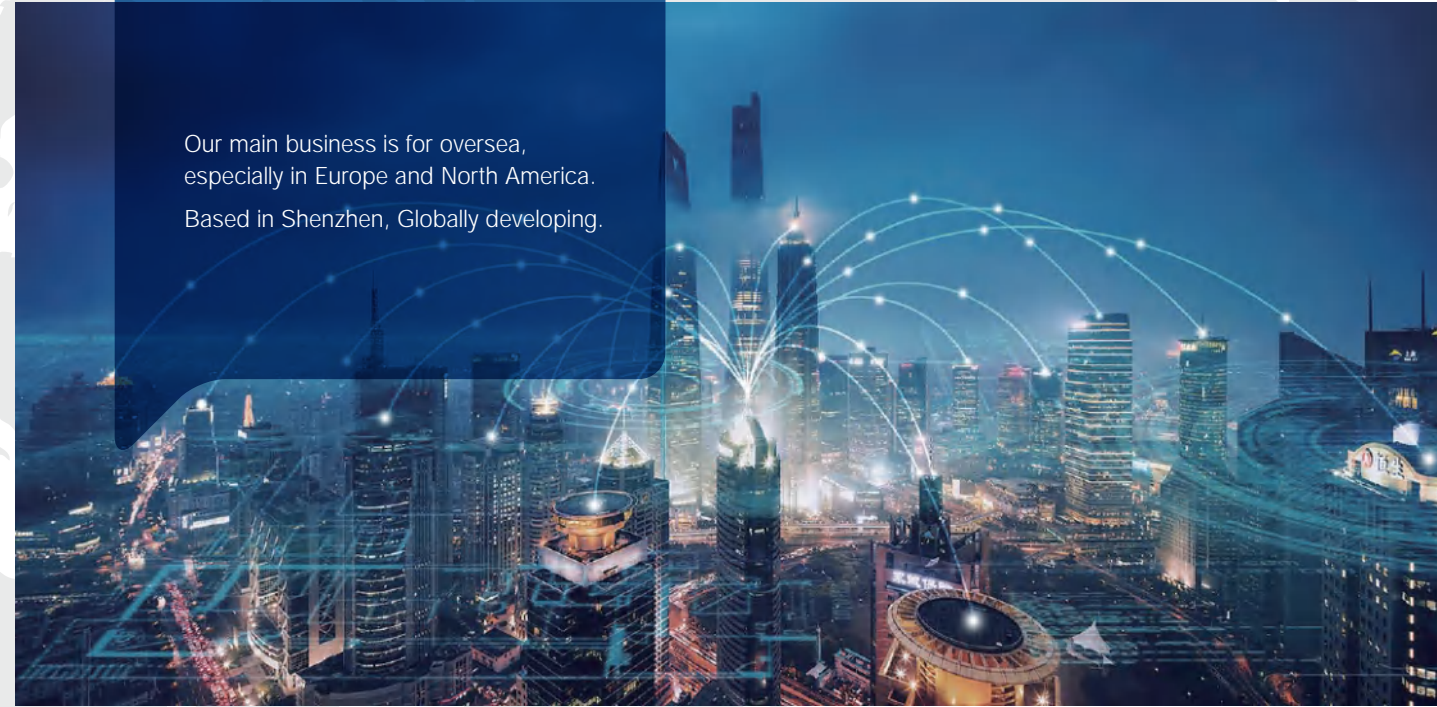

Our main business is for oversea, especially in Europe and North America. Based in Shenzhen, Globally developing.

We have got the high-tech enterprise license for many years. We get product patent licenses every year. At the same time, we cooperate with some universities to develop the new products.



Our Brand

Toppo Lighting have 2 brands and division for the different product ranges.



Toppo Brand focus on the low power LED lighting with over than 13 years experience. The product range include: Linear light, Batten light, Panel light, Bulkhead, Tri-proof light, Down light, Tube light, Etc.

The worldwide sales on the products make Toppo brand got the good reputation from the global customer which comes from the different countries from north american, European and others



TP-LUX Brand focus on the high power products such as: High bay light, Street light, Shoebox light, Gas station light, Bollard light, Postpot, etc. TP-LUX has over than 5 years experience on the high power lighting which has got the good reputation from the worldwide customer.

| | | |
|------------------------|--------------------------|---------------------|
| Value System | Morality as the basic | Quality as the life |
| Customer as the center | Innovation as the source | Result as the guide |

Certifications

PRODUCT CERTIFICATIONS

Our products are worldwide popular. All of the products have got the various of certifications, such as: UL / ETL / FCC / DLC / TUV-GS / TUV-CE / SAA / UKCA / ROHS / CB, etc. Under the growing on these years, our company also obtained various of license from the government, such as: "HI-TECH" enterprise, "S-R-D-I" enterprise, "china famous brand" enterprise, etc.

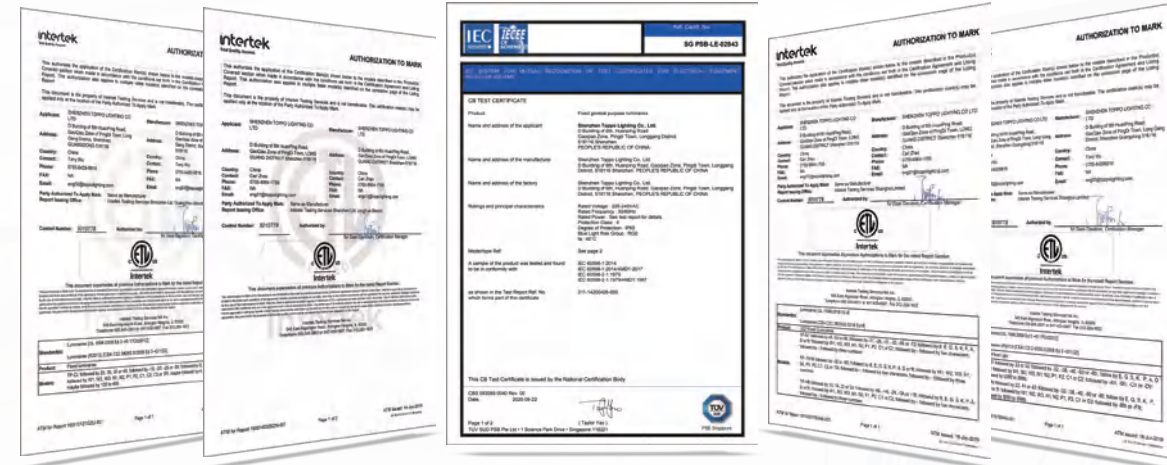

Enterprise Licenses

To insure the high quality management, we not only obtained the ISO system as the standard procedures for our daily operations, and also we use the advanced OA/ERP/CRM/PLM/WMS/SRM/MESS system to control the ISO procedures under the policy running.

Under the growing on these years, we also got many licenses from the government to make the company growing, such as: "HI-TECH" enterprise, "S-R-D-I" license, China "Famous Brand" license, etc. These licenses make us smoothly on the talents recruitment and company growing.

ISO9001:2015



ISO14001:2015



Alibaba verified license

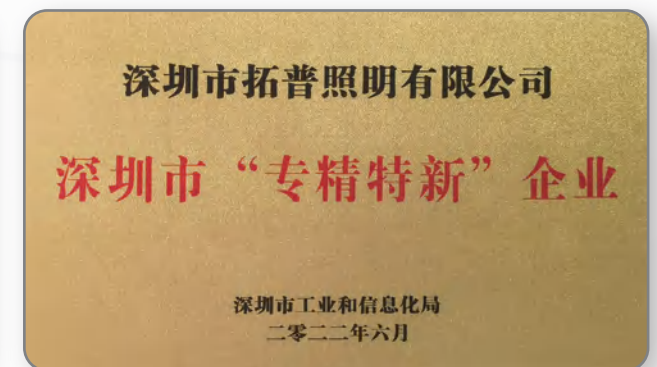

Why Toppo Lighting

Our Service, Your Choice

Our People, Here for you

"Character, Quality, Grade, Brand" as the core values of Toppo lighting, we always keep the "Talents are the first" concept to build our team. We always adhere to the core cultural concept of "organization for people, process for work, performance for value" and strive to build the company into a fertile land of "happy work, happy live" for all staff, so as to provide more opportunities for all staff's personal career growth and life goals.

We will always adhere "Saving energy as we can, Brighten the word as possible" corporate vision, to design and produce high quality led light to brighten your future modern life.



Factory Tour

"Customer is the first, Quality is priority" is our business philosophy. In order to ensure high effective operation and management, we not only use the ISO9001:2015 quality system and ISO14001:2015 environmental system as the basic management system, and also, we use the modern IT technology system to guarantee the operation of each procedures. The IT system include the below modules: HR/OA/CRM/PLM/ERP/SRM/WMS/MESS/AC. The management system and IT platform make us to achieve an excellent benefits on above each module. On the base of the above management system, we use the modern automatic product and ageing testing machine on the production to insure the quality and delivery to customers. We have serval numbers of automatic production line, ageing testing line and SMT workshop. It makes our monthly production capacity achieve more than 300,000pcs.



MARKETING DEPT



CONFERENCE ROOM



Production Line



SMT Workshop



Optical Testing



Automatic Aging Line



MECHANICAL ARM

Company Exhibition

HK LIGHTING SHOW





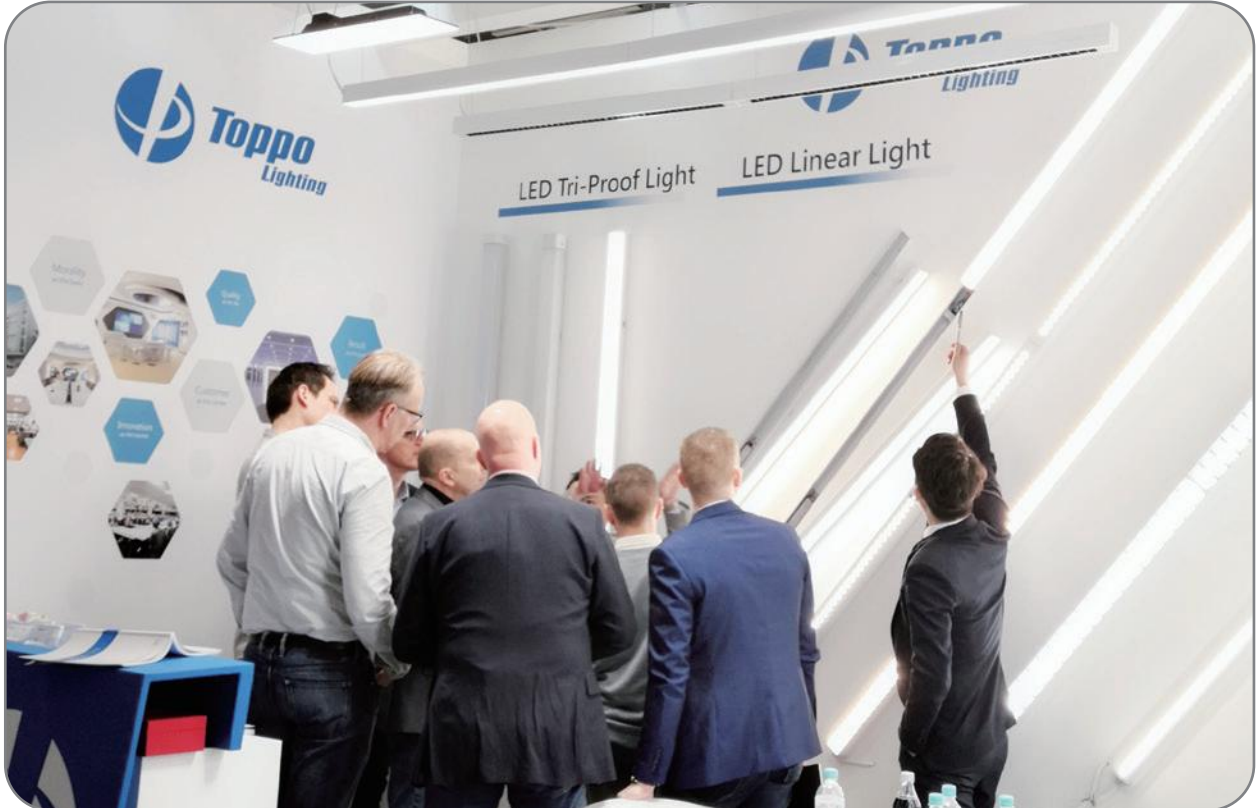











FRANKFURT LIGHTING SHOW



Contents



| | | |
|---------------------|---------|---------------------------------------------------------------------------------------|
| Low Glare Battens | 017-026 |  |
| Battens/ Linears | 027-038 |  |
| Trunk Linear System | 039-044 |  |
| Retro flex fittings | 045-050 |  |
| Pro-Line | 051-056 |  |
| Tri-proof lights | 057-063 |  |
| Tubar Lighting | 064-064 |  |
| NCF Luminaires | 065-068 |  |
| Bulkheads | 069-102 |  |
| Backlit Panels | 103-110 |  |
| Edgelit Panels | 111-120 |  |
| Down lights | 121-128 |  |
| LED Tubes | 129-132 |  |
| Cabinet Lights | 133-134 |  |

Product Guide

Product category/name: Weston Batten Low glare | 55mm

Product picture:

Certificate symbols: SAA, CE, UK CA, etc.

Dimension drawing:

Product profile: Weston is 55mm low glare linear which were used in the office / commercial / industrial / education applications. Aluminum case is a excellent heating sink, the high technology SMD2835 provide a more higher lumen output.

Key features/selling points:

- Features
 - > Low glare UGR<22
 - > End or rear cable entry
 - > Single or multiple link
 - > 5 years warranty

Options: Options for CCT/function/ electrical/photometric/ wiring/IP rating/finish, etc

Data Sheet

| Order Code | Rated Power | Lumen | LMW | Flicker Free | Dimension (mm) | GW/CTN | QTY/CTN |
|----------------------|-------------|----------|---------|--------------|---------------------|--------|---------|
| BT02-10KN1-SWN1E-001 | 10W | typ.1200 | typ.120 | Y | L605 X W55 X H63.5 | 6.0kg | 8pcs |
| BT04-17KN1-SWN1E-001 | 17W | typ.2040 | typ.120 | Y | L1205 X W55 X H63.5 | 11.5kg | 8pcs |
| BT05-22KN1-SWN1E-001 | 22W | typ.2640 | typ.120 | Y | L1505 X W55 X H63.5 | 14.5kg | 8pcs |
| BT06-27KN1-SWN1E-001 | 27W | typ.3240 | typ.120 | Y | L1805 X W55 X H63.5 | 17.0kg | 8pcs |
| BT08-50KN1-SWN1E-001 | 50W | typ.6000 | typ.120 | Y | L1805 X W55 X H63.5 | 17.0kg | 8pcs |









Order code: These unique codes relate to individual product specification

Package information for container

Contents



Product Guide

| | | |
|--------------------|---------|---------------------------------------------------------------------------------------|
| UFO Highbays | 137-146 |  |
| Linear Highbays | 147-154 |  |
| Modular Highbays | 155-160 |  |
| Street Lights | 161-164 |  |
| Shoebbox Lights | 165-168 |  |
| Posttops | 169-170 |  |
| Bollard Lights | 171-173 |  |
| Wall Packs | 174-176 |  |
| Gas Station Lights | 177-178 |  |

Product category/name

Product picture

Certificate symbols

Dimension drawing

Product profile

Key features/selling points

Options
Options for CCT/function/electrical/photometric/wiring/IP rating/finish, etc

Order code
These unique codes relate to individual product specification

Package information for container

T-line Linear Highbay
Asymmetric Honeycomb | 160lm/w

The asymmetric honeycomb T-Line Linear Highbay was designed to offer maximum efficacy, a long lifespan, glare protection, and a wide range of features. The unique and modern appearance heatsink design assures excellent heat dissipation for up to 200W and up to 160lm/w system efficacy with 5 years warranty. The special Asymmetric Honeycomb Reflectors reduces glaring with special supermarket applications.

Features

- > Highly energy efficacy - up to 160 lm/w
- > Advanced cooling-fins structure for 60°/90° degree heat dissipation
- > Superior honeycomb-reflector-optic for excellent Applications
- > Newest generation of SMD2835 1W LED chips
- > No UV or IR and completely mercury free
- > Various end cap colors available
- > L80/B10 @ 50,000h & 5 years warranty

Data Sheet

| Order Code | Rated Power | Lumen | LM/W | Flicker free | Dimension (mm) | GW/CTN | QTY/CTN |
|----------------------|-------------|-----------|---------|--------------|--------------------|--------|---------|
| HB02-1ATN1-TSNSS-001 | 100W | typ.16000 | typ.160 | Y | L623 X W138 X H73 | 5.9kg | 1pcs |
| HB03-1CTN1-TSNSS-001 | 120W | typ.19200 | typ.160 | Y | L923 X W138 X H73 | 7.9kg | 1pcs |
| HB03-1BTN1-TSNSS-001 | 150W | typ.24000 | typ.160 | Y | L923 X W138 X H73 | 7.9kg | 1pcs |
| HB04-2ATN1-TSNSS-001 | 200W | typ.32000 | typ.160 | Y | L1223 X W138 X H73 | 10.0kg | 1pcs |

TOPPO LIGHTING | www.toppolighting.com 004



Low Glare Batten

/Series/

- >Toppo LED Batten/Linear light is a complete LED solutions designed to replace fluorescent light fixtures of applications. The LED Battens are more and more popular nowadays, because it is more decorative and modern, while it also maintains more higher lumen efficiency. It is not only can be reach 140LM/W, but also the Batten/Linear can reach the UGR<19 in the office and education applications.
- >Toppo LED Batten/Linear light can be connected through the end or rear knock-outs in the end and rear of the unit, allowed end to end continuous installation.
- > The professional case style on the Batten/Linear light, simple opening design for easy installation make the client more interest in Toppo products.

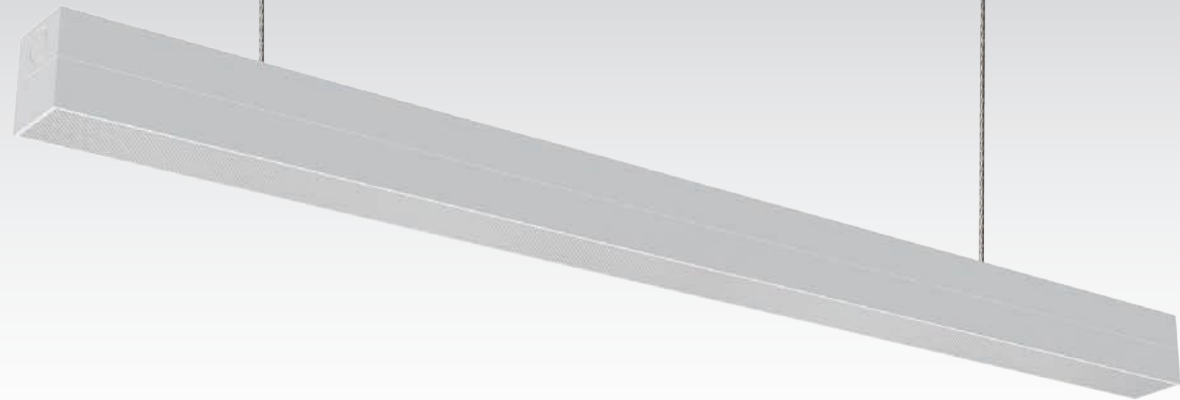

Weston Batten

Low glare | 55mm

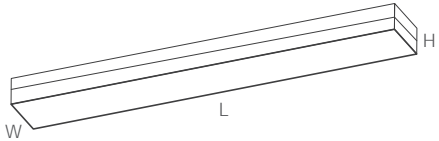

Weston is 55mm low glare linear which were widely used in the office / commercial / industrial / education applications. Aluminum case is an excellent heating sink, the high technology SMD2835 provide a more higher lumen output.

- ▶ Features
 - > Low glare UGR<22
 - > End or rear cable entry
 - > Single or multiple link
 - > 5 years warranty

- ▶ CCT
 - Single Color: 3000K, 4000K, 5000K, 6000K
 - Tri-color: 2700K, 3000K, 3500K, 4000K, 4500K, 5000K, 5500K, 6000K
- ▶ Function
 - ON/OFF
 - 1-10V Dimming
 - DALI
 - MS
 - PIR
 - Emergency
- ▶ Electrical Parameters
 - AC 200-240V
 - PF ≥0.95
 - THD <15%
 - Flicker Free
- ▶ Photometric Parameters
 - 120 LM/W
 - 140 LM/W
 - CRI>80 SDCM <5
 - UGR <22
 - LM79 TM-21
 - ERP2.0
- ▶ Wiring
 - Single wiring
 - Double wiring

▶ Data Sheet

| Order Code | Rated Power | Lumen | LM/W | Flicker Free | Dimension (mm) | GW/CTN | QTY/CTN |
|----------------------|-------------|----------|---------|--------------|---------------------|--------|---------|
| BT02-10KN1-SWN1E-001 | 10W | typ.1200 | typ.120 | Y | L605 X W55 X H63.5 | 6.0kg | 8pcs |
| BT04-17KN1-SWN1E-001 | 17W | typ.2040 | typ.120 | Y | L1205 X W55 X H63.5 | 11.5kg | 8pcs |
| BT04-34KN1-SWN1E-001 | 34W | typ.4080 | typ.120 | Y | L1205 X W55 X H63.5 | 11.5kg | 8pcs |
| BT05-22KN1-SWN1E-001 | 22W | typ.2640 | typ.120 | Y | L1505 X W55 X H63.5 | 14.5kg | 8pcs |
| BT05-40KN1-SWN1E-001 | 40W | typ.4800 | typ.120 | Y | L1505 X W55 X H63.5 | 14.5kg | 8pcs |
| BT06-27KN1-SWN1E-001 | 27W | typ.3240 | typ.120 | Y | L1805 X W55 X H63.5 | 17.0kg | 8pcs |
| BT06-50KN1-SWN1E-001 | 50W | typ.6000 | typ.120 | Y | L1805 X W55 X H63.5 | 17.0kg | 8pcs |

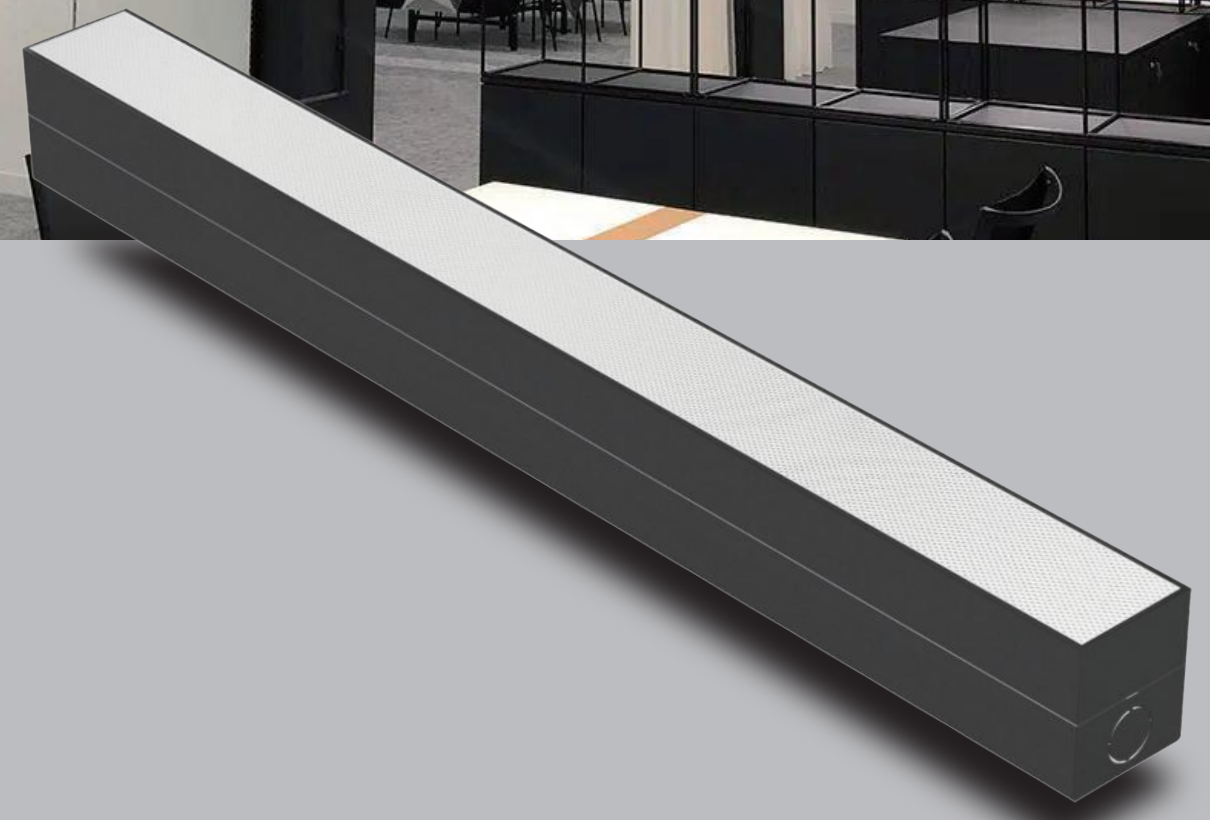

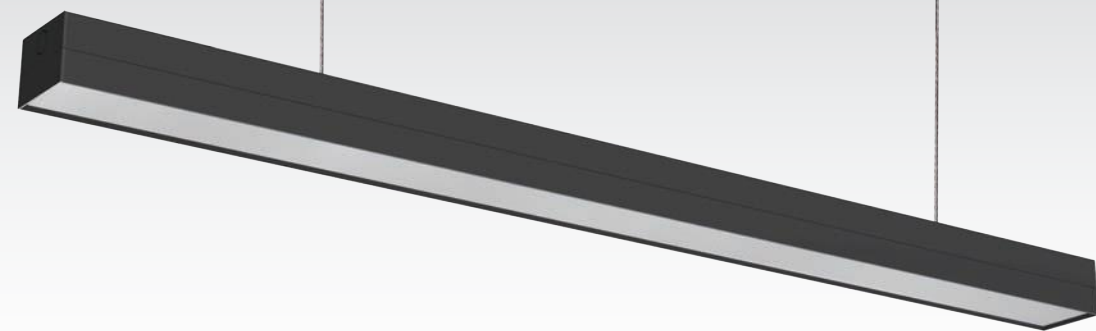

Upton Batten

Low glare | 80mm

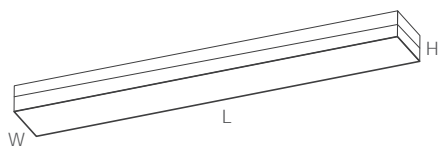

Upton Batten is 80mm low glare linear which were widely used on the office / commercial / industrial / education applications. Aluminum case is an excellent heating sink, the high technology SMD2835 provide a more higher lumen output.

Features

- > Low glare UGR<19
- > End or rear cable entry
- > Single or multiple link
- > 5 years warranty

Data Sheet

| Order Code | Rated Power | Lumen | LM/W | Flicker Free | Dimension (mm) | GW/CTN | QTY/CTN |
|----------------------|-------------|----------|---------|--------------|---------------------|--------|---------|
| BT02-10KN1-UGN1E-001 | 10W | typ.1200 | typ.120 | Y | L600 X W80 X H63.5 | 7.0kg | 6pcs |
| BT04-17KN1-UGN1E-001 | 17W | typ.2040 | typ.120 | Y | L1200 X W80 X H63.5 | 12.0kg | 6pcs |
| BT04-34KN1-UGN1E-001 | 34W | typ.4080 | typ.120 | Y | L1200 X W80 X H63.5 | 12.0kg | 6pcs |
| BT05-22KN1-UGN1E-001 | 22W | typ.2640 | typ.120 | Y | L1500 X W80 X H63.5 | 14.0kg | 6pcs |
| BT05-40KN1-UGN1E-001 | 40W | typ.4800 | typ.120 | Y | L1500 X W80 X H63.5 | 14.0kg | 6pcs |
| BT06-27KN1-UGN1E-001 | 27W | typ.3240 | typ.120 | Y | L1800 X W80 X H63.5 | 18.0kg | 6pcs |
| BT06-50KN1-UGN1E-001 | 50W | typ.6000 | typ.120 | Y | L1800 X W80 X H63.5 | 18.0kg | 6pcs |

CCT

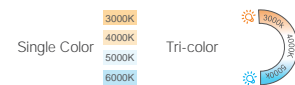

Function



Electrical Parameters



Photometric Parameters



Wiring



Upton Batten

Low glare | 80mm

Finish



White



Gray



Black



Kingston Batten

Low glare | 120mm

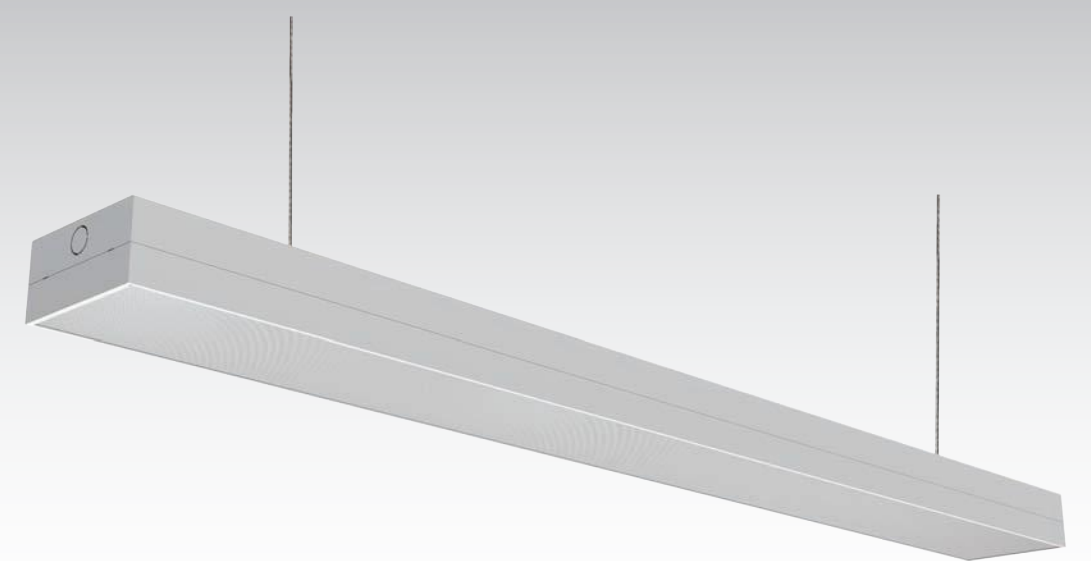

Kingston Batten

Low glare | 120mm

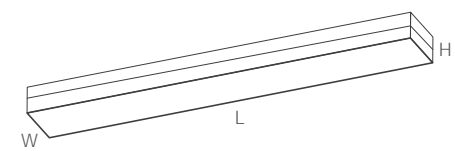

Kingston batten is a 120mm low glare batten with UGR<19. It was widely used on the office / commercial / industrial / education applications. Aluminum case is an excellent heating sink, the high technology SMD2835 provide a more higher lumen output.

- ▶ Features
 - > Low glare UGR<19
 - > End or rear cable entry
 - > Single or multiple link
 - > 5 years warranty

- ▶ CCT
 - Single Color: 3000K, 4000K, 5000K, 6000K
 - Tri-color: 3000K, 4000K, 5000K
- ▶ Function
 - ON/OFF
 - 1-10V Dimming
 - DALI
 - MS
 - PIR
 - Emergency
- ▶ Electrical Parameters
 - AC 200-240V
 - PF ≥0.95
 - THD <15%
 - Flicker Free
- ▶ Photometric Parameters
 - 120 LM/W
 - 140 LM/W
 - CRI>80 SDCM <5
 - UGR <19
 - LM79 TM-21
 - ERP2.0
- ▶ Wiring
 - Single wiring
 - Double wiring

▶ Data Sheet

| Order Code | Rated Power | Lumen | LM/W | Flicker Free | Dimension (mm) | GW/CTN | QTY/CTN |
|----------------------|-------------|----------|---------|--------------|----------------------|--------|---------|
| BT02-10KN1-KGN1E-001 | 10W | typ.1200 | typ.120 | Y | L600 X W120 X H63.5 | 7.0kg | 4pcs |
| BT04-17KN1-KGN1E-001 | 17W | typ.2040 | typ.120 | Y | L1200 X W120 X H63.5 | 10.5kg | 4pcs |
| BT04-34KN1-KGN1E-001 | 34W | typ.4080 | typ.120 | Y | L1200 X W120 X H63.5 | 10.5kg | 4pcs |
| BT05-22KN1-KGN1E-001 | 22W | typ.2640 | typ.120 | Y | L1500 X W120 X H63.5 | 13.0kg | 4pcs |
| BT05-40KN1-KGN1E-001 | 40W | typ.4800 | typ.120 | Y | L1500 X W120 X H63.5 | 13.0kg | 4pcs |
| BT06-27KN1-KGN1E-001 | 27W | typ.3240 | typ.120 | Y | L1800 X W120 X H63.5 | 15.5kg | 4pcs |
| BT06-50KN1-KGN1E-001 | 50W | typ.6000 | typ.120 | Y | L1800 X W120 X H63.5 | 15.5kg | 4pcs |

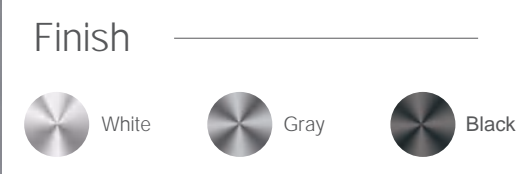

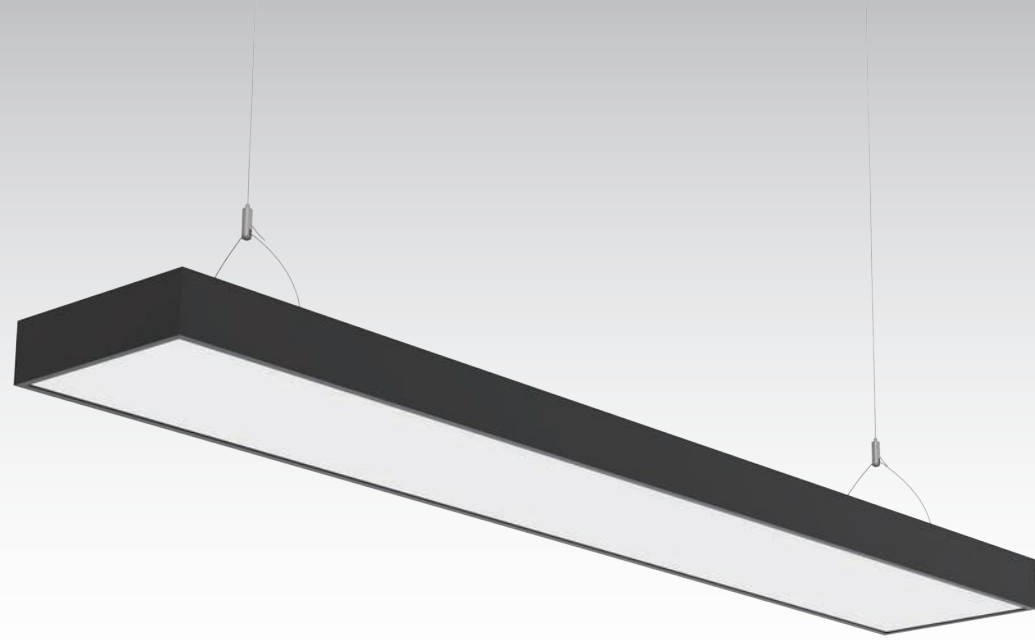

Kaston Batten

Low glare | 200mm

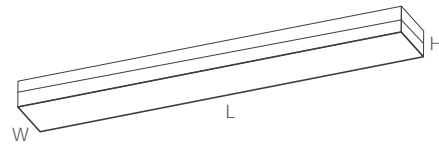

Kaston Batten is a 200mm low glare linear which were widely used on the office / commercial / industrial / education applications. Aluminum case is an excellent heating sink, the high technology SMD2835 provide a more higher lumen output.

► Features

- > Low glare UGR<19
- > End or rear cable entry
- > Single or multiple link
- > 5 years warranty

► Data Sheet

| Order Code | Rated Power | Lumen | LM/W | Flicker Free | Dimension (mm) | GW/CTN | QTY/CTN |
|----------------------|-------------|----------|---------|--------------|--------------------|--------|---------|
| BT04-25KN1-UGN1E-001 | 25W | typ.3100 | typ.125 | Y | L1200 X W200 X H64 | 18.5kg | 3pcs |
| BT04-40KN1-UGN1E-001 | 40W | typ.5000 | typ.125 | Y | L1200 X W200 X H64 | 18.5kg | 3pcs |
| BT05-45KN1-UGN1E-001 | 45W | typ.5600 | typ.125 | Y | L1500 X W200 X H64 | 22.0kg | 3pcs |
| BT05-60KN1-UGN1E-001 | 60W | typ.7500 | typ.125 | Y | L1500 X W200 X H64 | 22.0kg | 3pcs |

► CCT

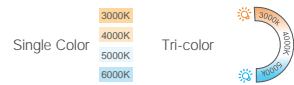

► Function



► Electrical Parameters



► Photometric Parameters



► Wiring



Kaston Batten

Low glare | 200mm

Finish



White



Gray



Black

Batten Light Linear Light

/Series/

- >Toppo LED Batten/Linear light is a complete LED solutions designed to replace fluorescent light fixtures of applications. The LED Battens are more and more popular nowadays, because it is more decorative and modern, while it also maintains more higher lumen efficiency up to 160LM/W meet the different applications of customers, such as offices, shopping malls, supermarkets, corridors, villas, gyms, rooms, etc.
- >Toppo LED Batten/Linear light can be connected through the end or rear knock-outs in the end and rear of the unit, allowed end to end continuous installation.
- > The professional case style on the Batten/Linear light, simple opening design for easy installation make the client and more interest in Toppo products.





Slim Batten

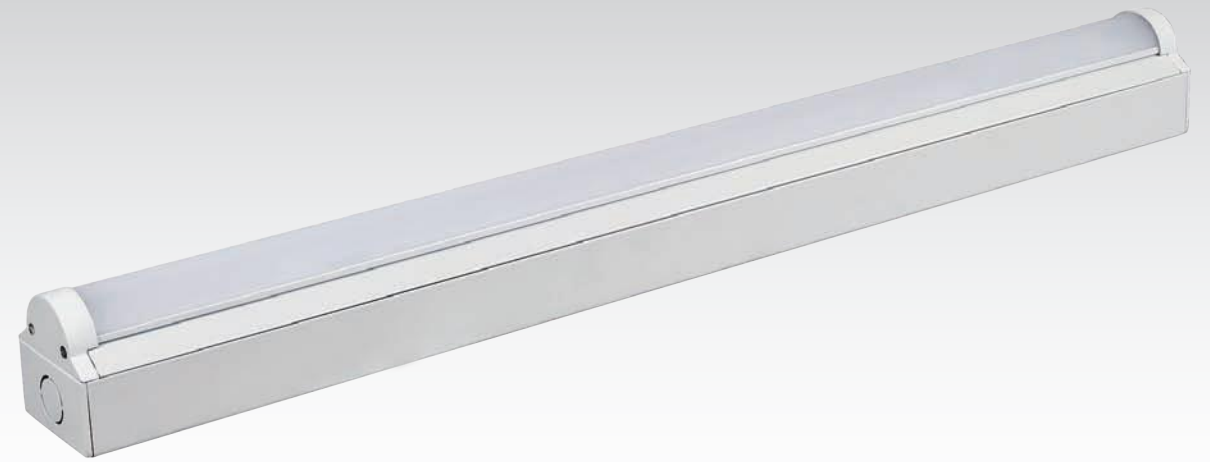

T8 Slim Batten

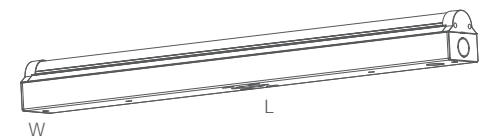

The T8 slim batten have super simple construction and superior capability, with milky, PC diffuser achieves anti-glare and high light transmittance. It is high efficient product with quite large potential market. Integrated 3CCTs to provide flexibility to customer. 4 standard sizes are replacement for T8/T5 fluorescent fitting perfectly.

► Features

- > Patent design for T8 fluorescent fitting
- > End or rear cable entry
- > Multiple Link through end rear
- > Easy installation
- > 5 years warranty

► CCT

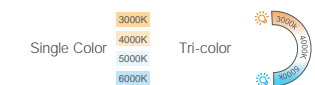

► Function



► Electrical Parameters



► Photometric Parameters



► Wiring



► Finish



► Data Sheet

| Order Code | Rated Power | Lumen | LM/W | Flicker Free | Dimension (mm) | GW/CTN | QTY/CTN |
|----------------------|-------------|----------|---------|--------------|-------------------|--------|---------|
| BT02-10DN1-STN1E-001 | 10W | typ.1600 | typ.160 | Y | L600 X W55 X H58 | 6.4kg | 10pcs |
| BT04-17DN1-STN1E-001 | 17W | typ.2720 | typ.160 | Y | L1200 X W55 X H58 | 11.3kg | 10pcs |
| BT04-32DN1-STN1E-001 | 32W | typ.5120 | typ.160 | Y | L1200 X W55 X H58 | 11.3kg | 10pcs |
| BT05-28DN1-STN1E-001 | 28W | typ.4480 | typ.160 | Y | L1500 X W55 X H58 | 14.5kg | 10pcs |
| BT05-56DN1-STN1E-001 | 56W | typ.8960 | typ.160 | Y | L1500 X W55 X H58 | 14.5kg | 10pcs |
| BT06-32DN1-STN1E-001 | 32W | typ.5120 | typ.160 | Y | L1800 X W55 X H58 | 17.8kg | 10pcs |
| BT06-62DN1-STN1E-001 | 62W | typ.9920 | typ.160 | Y | L1800 X W55 X H58 | 17.8kg | 10pcs |

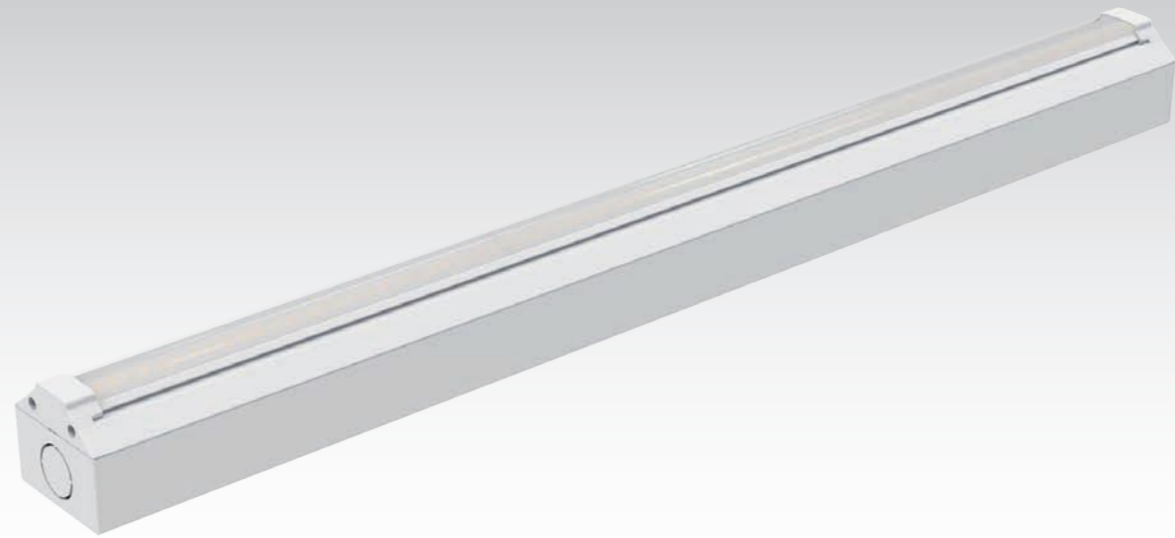

Narrow Slim Batten

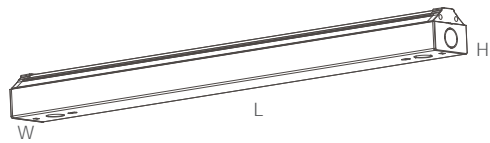

Narrow slim batten offers a homogeneous light output and has a slim housing. 80 degree beam angle focus on the light area, widely used in warehouse, corridor, office, factories, supermarkets, etc. It offers ultra-high efficiency up to 160lm/W utilising latest LED chip technology.

► Features

- > Own design for traditional fluorescent batten
- > End or rear cable entry
- > Multiple Link through end hole
- > Easy installation
- > 5 years warranty

► Data Sheet

| Order Code | Rated Power | Lumen | LM/W | Flicker Free | Dimension (mm) | GW/CTN | QTY/CTN |
|----------------------|-------------|-----------|---------|--------------|-------------------|--------|---------|
| BT04-17DN1-SNN1E-001 | 17W | typ.2720 | typ.160 | Y | L1200 X W55 X H50 | 11.3kg | 10pcs |
| BT04-32DN1-SNN1E-001 | 32W | typ.5120 | typ.160 | Y | L1200 X W55 X H50 | 11.3kg | 10pcs |
| BT05-28DN1-SNN1E-001 | 28W | typ.4480 | typ.160 | Y | L1500 X W55 X H50 | 14.5kg | 10pcs |
| BT05-56DN1-SNN1E-001 | 56W | typ.8960 | typ.160 | Y | L1500 X W55 X H50 | 14.5kg | 10pcs |
| BT06-32DN1-SNN1E-001 | 32W | typ.5120 | typ.160 | Y | L1800 X W55 X H50 | 17.8kg | 10pcs |
| BT06-62DN1-SNN1E-001 | 62W | typ.9920 | typ.160 | Y | L1800 X W55 X H50 | 17.8kg | 10pcs |
| BT06-72DN1-SNN1E-001 | 72W | typ.11520 | typ.160 | Y | L1800 X W55 X H50 | 17.8kg | 10pcs |



- CCT: Single Color (3000K, 4000K, 5000K, 6000K), Tri-color (2700K, 3000K, 3500K, 4000K)
- Function: ON/OFF, 1-10V Dimming, DALI, PIR, Emergency
- Electrical Parameters: AC 200-240V, PF ≥0.95, THD <15%, Flicker Free
- Photometric Parameters: 120 LM/W, 140 LM/W, 160 LM/W; CRI >80 SDCM <5, LM79 TM-21, ERP2.0
- Wiring: Single wiring, Double wiring
- Finish: White, Gray, Black



Frosted Slim Batten

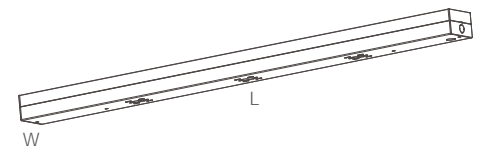

Frosted slim batten is a perfect replacement for traditional light. Aluminum housing provides an excellent thermal management. Opal PC diffuser provide high transparency. Excellent appearance is suitable for various high-end offices, hotel lobbies, conference rooms, classrooms.

► Features

- > Own design for traditional fluorescent batten
- > End or rear cable entry
- > Multiple Link through end hole
- > Easy installation
- > 5 years warranty

► Data Sheet

| Order Code | Rated Power | Lumen | LM/W | Flicker Free | Dimension (mm) | GW/CTN | QTY/CTN |
|----------------------|-------------|----------|---------|--------------|---------------------|--------|---------|
| BT02-10DN1-SFN1E-001 | 10W | typ.1600 | typ.160 | Y | L600 X W55 X H63.5 | 5.8kg | 8pcs |
| BT04-17DN1-SFN1E-001 | 17W | typ.2720 | typ.160 | Y | L1200 X W55 X H63.5 | 11.5kg | 8pcs |
| BT04-32DN1-SFN1E-001 | 32W | typ.5120 | typ.160 | Y | L1200 X W55 X H63.5 | 11.5kg | 8pcs |
| BT05-28DN1-SFN1E-001 | 28W | typ.4480 | typ.160 | Y | L1500 X W55 X H63.5 | 14.5kg | 8pcs |
| BT05-56DN1-SFN1E-001 | 56W | typ.8960 | typ.160 | Y | L1500 X W55 X H63.5 | 14.5kg | 8pcs |
| BT06-32DN1-SFN1E-001 | 32W | typ.5120 | typ.160 | Y | L1800 X W55 X H63.5 | 17.0kg | 8pcs |
| BT06-62DN1-SFN1E-001 | 62W | typ.9920 | typ.160 | Y | L1800 X W55 X H63.5 | 17.0kg | 8pcs |



- CCT: Single Color (3000K, 4000K, 5000K, 6000K), Tri-color (2700K, 3000K, 3500K, 4000K)
- Function: ON/OFF, 1-10V Dimming, DALI, PIR, Emergency
- Electrical Parameters: AC 200-240V, PF ≥0.95, THD <15%, Flicker Free
- Photometric Parameters: 120 LM/W, 140 LM/W, 160 LM/W; CRI >80 SDCM <5, LM79 TM-21, ERP2.0
- Wiring: Single wiring, Double wiring
- Finish: White, Gray, Black



Wega Batten

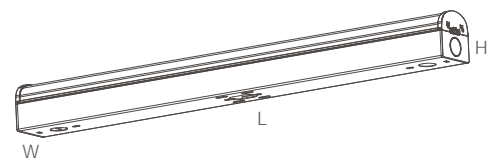

Safety-lock-mechanism design for quick installation. Osram driver as standard and adopts SMD high lumen efficiency 160lm/W is good lighting solution. The iron lamp body provides excellent heat dissipation.

► Features

- > High lumen efficiency – up to 160lm/W
- > Safety-lock-mechanism for a secure installation
- > Durable sheet-metal casing with end/rear cables entries
- > Milky PC cover with 85% transparency and 120° beam angle
- > Suitable for surface mounting or suspended installation
- > Perfect replacement for traditional T5/T8 fittings
- > OSRAM driver as standard
- > 5 year warranty

► Data Sheet

| Order Code | Rated Power | Lumen | LM/W | Flicker Free | Dimension (mm) | GW/CTN | QTY/CTN |
|----------------------|-------------|----------|---------|--------------|-------------------|--------|---------|
| BT02-10DN1-WGN1E-001 | 10W | typ.1600 | typ.160 | Y | L600 X W55 X H59 | 7.5kg | 10pcs |
| BT04-18DN1-WGN1E-001 | 18W | typ.2880 | typ.160 | Y | L1200 X W55 X H59 | 12.4kg | 10pcs |
| BT04-35DN1-WGN1E-001 | 35W | typ.5600 | typ.160 | Y | L1200 X W55 X H59 | 12.4kg | 10pcs |
| BT05-29DN1-WGN1E-001 | 29W | typ.4640 | typ.160 | Y | L1500 X W55 X H59 | 14.5kg | 10pcs |
| BT05-55DN1-WGN1E-001 | 55W | typ.8800 | typ.160 | Y | L1500 X W55 X H59 | 15.5kg | 10pcs |
| BT06-35DN1-WGN1E-001 | 35W | typ.5600 | typ.160 | Y | L1800 X W55 X H59 | 18.8kg | 10pcs |
| BT06-55DN1-WGN1E-001 | 55W | typ.8800 | typ.160 | Y | L1800 X W55 X H59 | 18.8kg | 10pcs |

- CCT: Single Color (3000K, 4000K, 5000K, 6000K), Tri-color (2700K, 3000K, 3500K, 4000K)
- Function: ON/OFF, PIR, DALI, Emergency
- Electrical Parameters: AC 200-240V, PF ≥0.95, THD <15%, Flicker Free
- Photometric Parameters: 120 LM/W, 140 LM/W, 160 LM/W; CRI>80 SDCM <5, LM79 TM-21, ERP2.0
- Wiring: Single wiring, Double wiring
- Finish: White, Gray, Black



Arco Batten

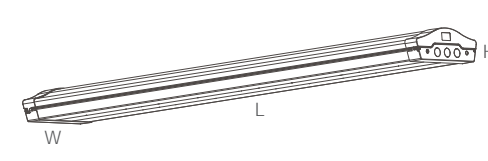

ARCO Batten is an extra wide-body LED batten featuring an aesthetically pleasing low-glare design that used widely in offices, universities, colleges, schools, hospitals.

► Features

- > College Fitting / College Batten
- > 0.7mm steel case +1.8mm TP(b) cover
- > Safety lock to prevent accidental opening
- > Various of functions for options
- > High lumen output at 160lm/W
- > Rotatable end cap for easy opening and installation
- > 5 years warranty

► Data Sheet

| Order Code | Rated Power | Lumen | LM/W | Flicker Free | Dimension (mm) | GW/CTN | QTY/CTN |
|----------------------|-------------|----------|---------|--------------|--------------------|--------|---------|
| BT04-17DN1-AFF1E-001 | 17W | typ.1600 | typ.160 | Y | L1200 X W215 X H77 | 17.5kg | 5pcs |
| BT04-32DN1-AFF1E-001 | 32W | typ.5120 | typ.160 | Y | L1200 X W215 X H77 | 17.5kg | 5pcs |
| BT05-25DN1-AFF1E-001 | 25W | typ.4000 | typ.160 | Y | L1500 X W215 X H77 | 21.6kg | 5pcs |
| BT05-50DN1-AFF1E-001 | 50W | typ.8000 | typ.160 | Y | L1500 X W215 X H77 | 21.6kg | 5pcs |
| BT05-60DN1-AFF1E-001 | 60W | typ.9600 | typ.160 | Y | L1500 X W215 X H77 | 21.6kg | 5pcs |

- CCT: Single Color (3000K, 4000K, 5000K, 6000K), Tri-color (2700K, 3000K, 3500K, 4000K)
- Function: ON/OFF, 1-10V Dimming, DALI, MS, Emergency, Low Glare
- Electrical Parameters: AC 200-240V, PF ≥0.95, THD <15%, Flicker Free
- Photometric Parameters: 120 LM/W, 140 LM/W, 160 LM/W; CRI>80 SDCM <5, LM79 TM-21, ERP2.0
- Wiring: Single wiring, Double wiring
- Finish: White, Gray, Black

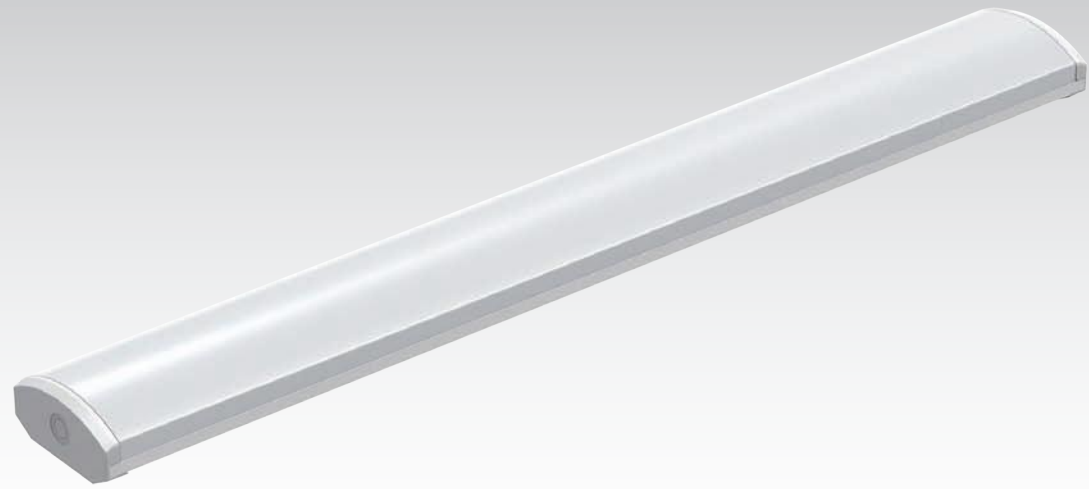

General Batten

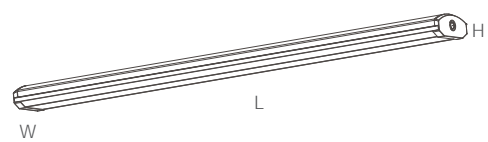

General Batten adopts separated module design, has been improved to have a wider lighting emitting area. Color temperature and wattage both switchable. Mounting design: suspension / surface mounting

► Features

- > Various of functions for options
- > High lumen output at 160lm/W
- > Easy Installation
- > 5 years warranty

► Data Sheet

| Order Code | Rated Power | Lumen | LM/W | Flicker Free | Dimension (mm) | GW/CTN | QTY/CTN |
|----------------------|-------------|----------|---------|--------------|--------------------|--------|---------|
| BT04-17DN1-GMN1E-001 | 17W | typ.2720 | typ.160 | Y | L1200 X W152 X H77 | 9.2kg | 4pcs |
| BT04-32DN1-GMN1E-001 | 32W | typ.5120 | typ.160 | Y | L1200 X W152 X H77 | 9.2kg | 4pcs |
| BT05-25DN1-GMN1E-001 | 25W | typ.4000 | typ.160 | Y | L1500 X W152 X H77 | 11.2kg | 4pcs |
| BT05-50DN1-GMN1E-001 | 50W | typ.8000 | typ.160 | Y | L1500 X W152 X H77 | 11.2kg | 4pcs |

- CCT: Single Color (3000K, 4000K, 5000K, 6000K), Tri-color (2700K, 3000K, 3500K, 4000K, 4500K, 5000K, 5500K, 6000K)
- Function: ON/OFF, 1-10V Dimming, DALI, Emergency
- Electrical Parameters: AC 200-240V, PF ≥0.95, THD <15%, Flicker Free
- Photometric Parameters: 120 LM/W, 140 LM/W, 160 LM/W; CRI>80 SDCM <5, LM79 TM-21, ERP2.0
- Wiring: Single wiring, Double wiring
- Finish: White, Gray, Black

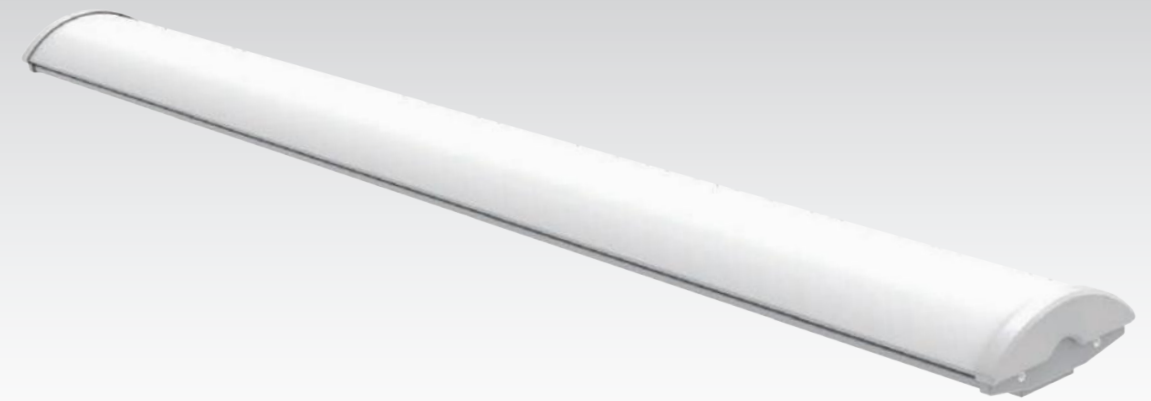

Oxford Batten

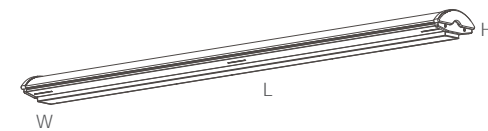

Oxford Batten adopts unique module design to have a wide lighting emitting area, the semi-circular shape makes it emit a uniform light effect, bringing a high-level texture. Color temperature and wattage both switchable. Suspension / surface mounting designed for school lighting, office lighting applications, etc.

► Features

- > Various of functions for options
- > High lumen output at 160lm/W
- > Easy Installation
- > 5 years warranty

► Data Sheet

| Order Code | Rated Power | Lumen | LM/W | Flicker Free | Dimension (mm) | GW/CTN | QTY/CTN |
|----------------------|-------------|----------|---------|--------------|--------------------|--------|---------|
| BT04-20DN1-XFN1E-001 | 20W | typ.3200 | typ.160 | Y | L1190 X W165 X H75 | 11.8kg | 5pcs |
| BT04-34DN1-XFN1E-001 | 34W | typ.5440 | typ.160 | Y | L1190 X W165 X H75 | 11.8kg | 5pcs |
| BT05-24DN1-XFN1E-001 | 24W | typ.3840 | typ.160 | Y | L1470 X W165 X H75 | 14.0kg | 5pcs |
| BT05-40DN1-XFN1E-001 | 40W | typ.6400 | typ.160 | Y | L1470 X W165 X H75 | 14.0kg | 5pcs |
| BT06-32DN1-XFN1E-001 | 32W | typ.5120 | typ.160 | Y | L1800 X W165 X H75 | 17.7kg | 5pcs |
| BT06-50DN1-XFN1E-001 | 50W | typ.8000 | typ.160 | Y | L1800 X W165 X H75 | 17.7kg | 5pcs |

- CCT: Single Color (3000K, 4000K, 5000K, 6000K), Tri-color (2700K, 3000K, 3500K, 4000K, 4500K, 5000K, 5500K, 6000K)
- Function: ON/OFF, 1-10V Dimming, DALI, MS, PIR, Emergency
- Electrical Parameters: AC 200-240V, PF ≥0.95, THD <15%, Flicker Free
- Photometric Parameters: 120 LM/W, 140 LM/W, 160 LM/W; CRI>80 SDCM <5, LM79 TM-21, ERP2.0
- Wiring: Single wiring, Double wiring
- Finish: White, Gray, Black



Polo suspend linear

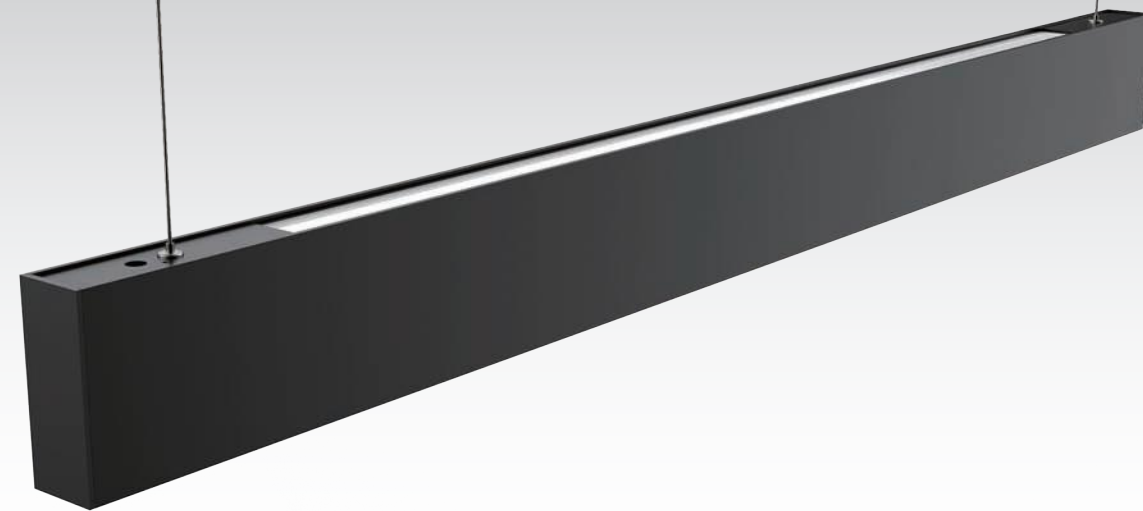

Polo suspend linear

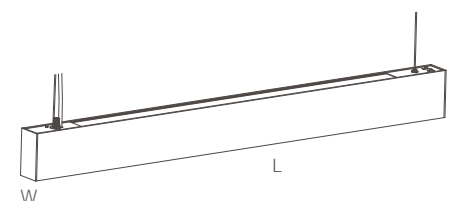

Polo suspend linear is an UP/down linear lighting which has various of function on the junction box on the ceiling Direct / indirect lighting combination, CCT adjustable, emergency and sensor function. Application for resident, commercial, office, educational, architectural, decorative.



Features

- > Separate control of the direct and indirect light
- > 120cm 36W Down+6W Up, 150cm 50W Down+6W Up
- > Constructed by Aluminum for heating dispatching
- > 3 steps switch for Tri-color option
- > The driver, EM kits, Sensor is built-in the junction box
- > Easy Installation



Data Sheet

| Order Code | Rated Power | Lumen | LM/W | Flicker Free | Dimension (mm) | GW/CTN | QTY/CTN |
|----------------------|-------------|----------|---------|--------------|--------------------|--------|---------|
| BT04-36GN1-PLF1J-001 | 36W | typ.3780 | typ.105 | Y | L1122 X W40 X H100 | 15.7kg | 5pcs |
| BT04-50GN1-PLF1J-001 | 50W | typ.5250 | typ.105 | Y | L1122 X W40 X H100 | 15.7kg | 5pcs |
| BT05-50GN1-PLF1J-001 | 50W | typ.5250 | typ.105 | Y | L1422 X W40 X H100 | 19.7kg | 5pcs |

▶ CCT

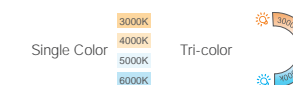

▶ Function

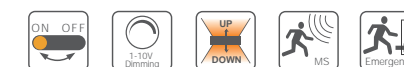

▶ Electrical Parameters



▶ Photometric Parameters



▶ Finish





Trunk Linear System

Max 200 Meters Multiple Tool-free Installation

- > Trunk linear system is an own designed multiple link led linear light system, which provide the optimized lighting solution for industrial and commerical applications, such as: Supermarkets, Shopping malls, Offices, Conference rooms, factories, Warehouses, Car pars, Airports, Stations, etc.
- > Trunk linear system comprises of trunk rail, lighting module and accessories. The pre-wired 5/7 wires trunk rail provide the AC power and control signals to light modules. The 5 different light module make the trunk linear system were widely used in the different application.
- > Trunk linears system delivers a tool free installation which can be max 200 meters multiple link.
- > See the below pages for the detailed product information of the trunk linear system.

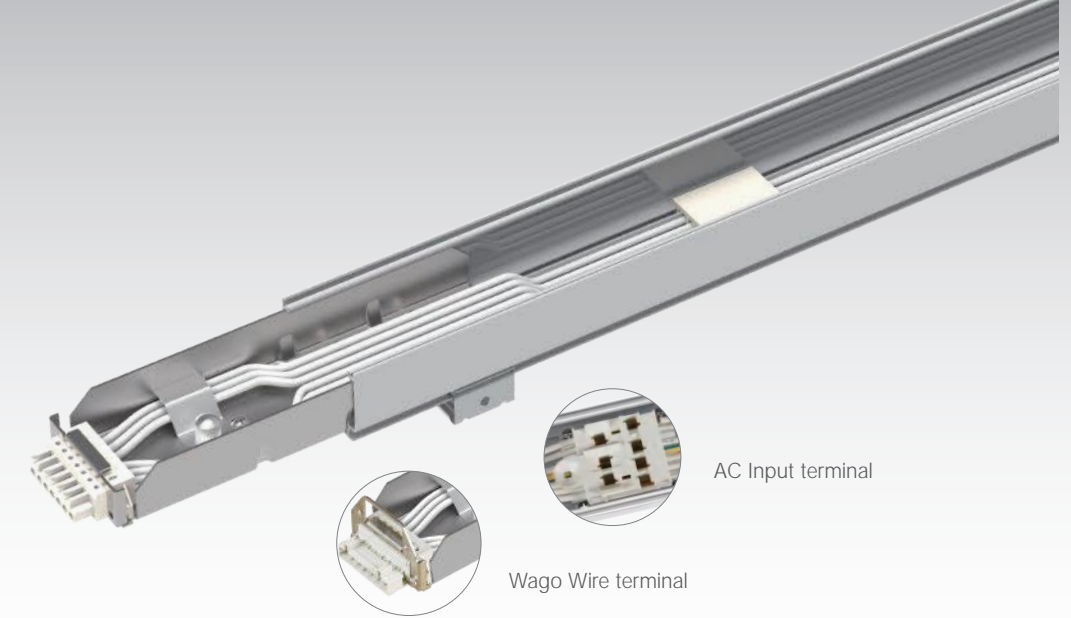
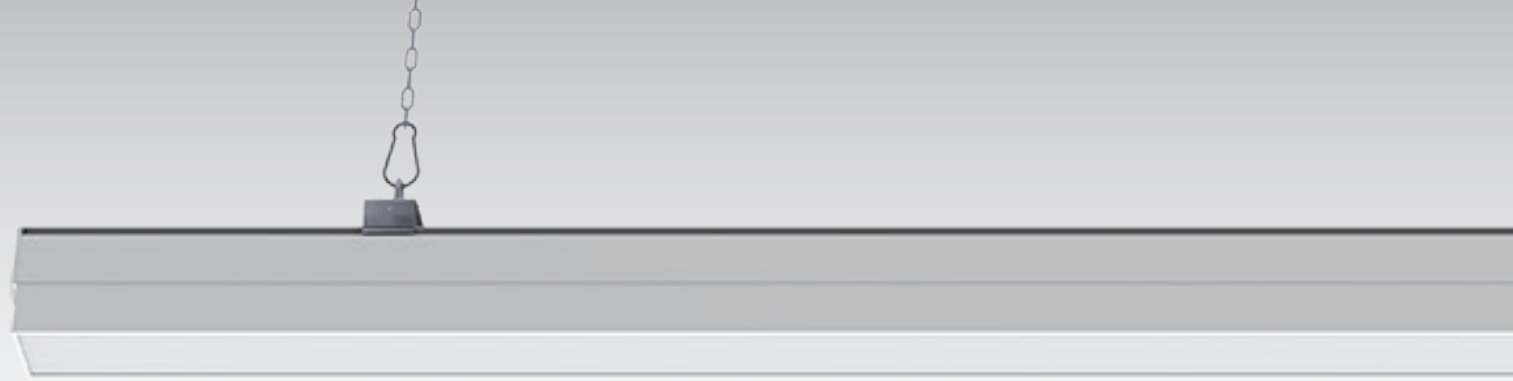

Trunk Linear System



Complete Trunk Linear System adopts separated light modules, trunk rail and mode connectors.

► Features

- > Pre wired 5/7 wires trunk rail
- > Various lighting module
- > Tool Free installation
- > Max 200 meters multiple link
- > 3-phase AC power source
- > Starting unit for one times AC power connect

► Explosion drawing

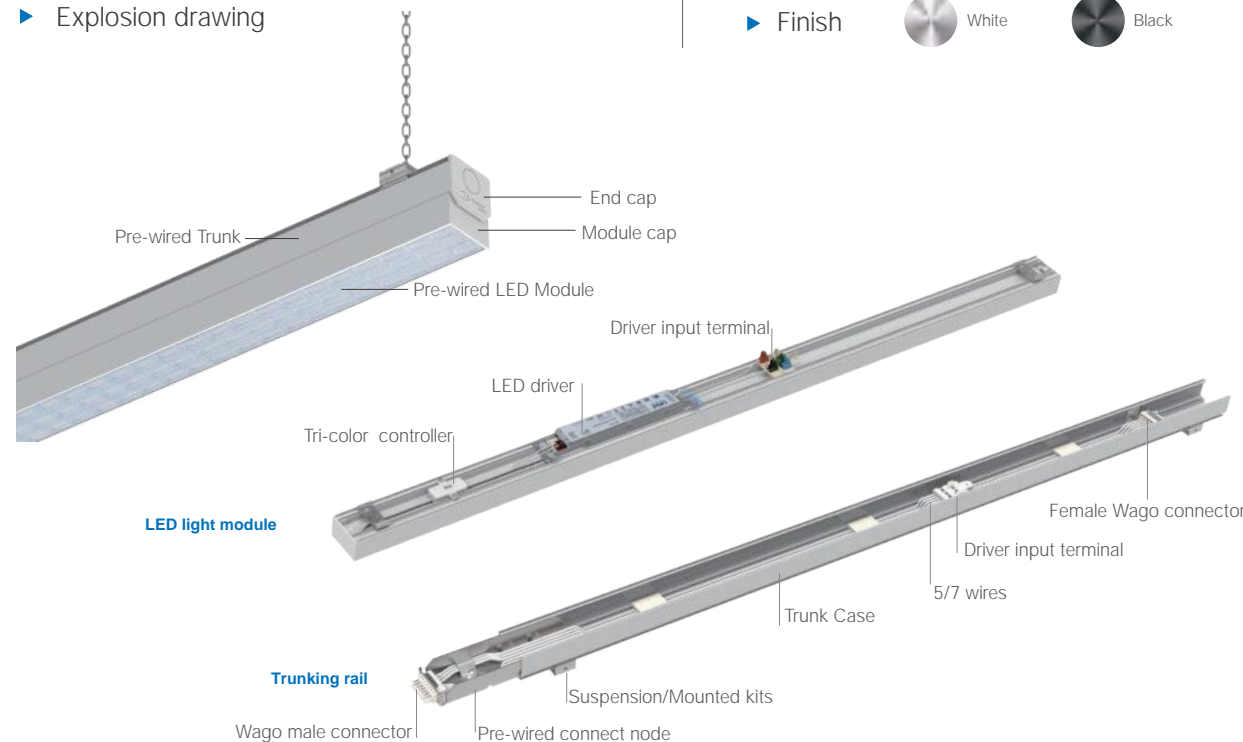

- CCT: Single Color (3000K, 4000K, 5000K, 6000K), Tri-color (2700K, 3000K, 3500K, 4000K)
- Function: ON/OFF, 1-10V Dimming, DALI, MS, Emergency
- Electrical Parameters: CLO, AC 200-240V, PF ≥0.95, THD <15%, Flicker Free
- Photometric Parameters: 120 LM/W, 140 LM/W, 160 LM/W, CRI>80 SDCM <5, LM79 TM-21, ERP2.0
- Wiring: 5 Wires, 7 Wires
- Light Module: See below pages
- Finish: White, Black

Trunk Linear Pre-wired trunk rail

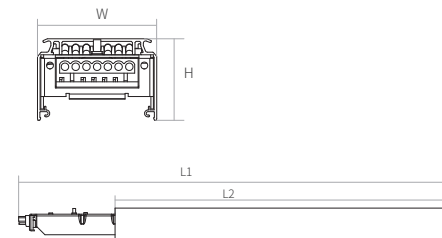

The trunk rails are pre-wired sections. Which provide the AC power and control signals to modules. The trunk rail has 5/7 wires style which meet the different modules. The available length are 0.6m, 1.2m, 1.5m, 2.4m, 3.0m. The mode connectors with wired WAGO terminal on both sides of the trunk rail not only make the tool free installation but also make the installation directions.

► 5 Wires Diagram

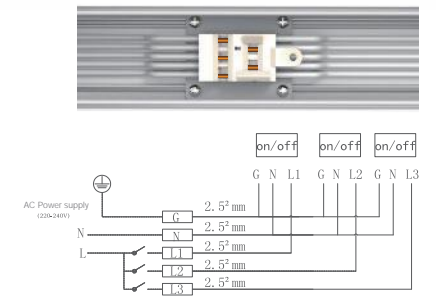

► 7 Wires Diagram

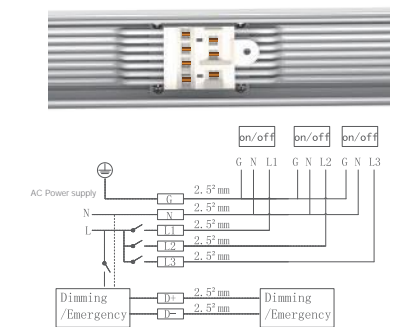

► Trunk rail data sheet

| Product name | Order Code | Wires | Suitable For | Dimension (mm) | QTY/CTN |
|-----------------|---------------|-------|--------------------------------------------|-------------------|---------|
| 0.6m trunk rail | TS-TN06-05-F1 | 5 | 3-phase operation + ON-OFF | L605 X W55 X H38 | 10pcs |
| | TS-TN06-07-F2 | 7 | 3-phase operation + ON-OFF + Dimming or EM | L605 X W55 X H38 | 10pcs |
| 1.2m trunk rail | TS-TN12-07-F2 | 5 | 3-phase operation + ON-OFF | L1205 X W55 X H38 | 10pcs |
| | TS-TN12-05-F1 | 7 | 3-phase operation + ON-OFF + Dimming or EM | L1205 X W55 X H38 | 10pcs |
| 2.4m trunk rail | TS-TN24-05-F1 | 5 | 3-phase operation + ON-OFF | L2410 X W55 X H38 | 10pcs |
| | TS-TN24-07-F2 | 7 | 3-phase operation + ON-OFF + Dimming or EM | L2410 X W55 X H38 | 10pcs |
| 1.5m trunk rail | TS-TN15-05-F1 | 5 | 3-phase operation + ON-OFF | L1505 X W55 X H38 | 10pcs |
| | TS-TN15-07-F2 | 7 | 3-phase operation + ON-OFF + Dimming or EM | L1505 X W55 X H38 | 10pcs |
| 3.0m trunk rail | TS-TN30-05-F1 | 5 | 3-phase operation + ON-OFF | L3010 X W55 X H38 | 10pcs |
| | TS-TN30-07-F2 | 7 | 3-phase operation + ON-OFF + Dimming or EM | L3010 X W55 X H38 | 10pcs |



Trunk Linear Light module | Start unit



Start unit



Lens Module



Frosted Module



Gentle Module



Narrow Module



T8 Module

▶ Start unit

| Order Code | Product name | Speci cation |
|---------------|--------------------|--------------------|
| TS-FM03-05-ST | 5 wires Start unit | For 5 wires system |
| TS-FM03-07-ST | 7 wires Start unit | For 7 wires system |

▶ Lens Module (30°/60°/90°/LR25 Optional)

| Order Code | Wattage | Lumen | LM/W | Flicker Free | Dimension (mm) | GW/CTN | QTY/CTN |
|---------------------|---------|-----------|---------|--------------|-------------------|--------|---------|
| TS-LM12-25AN1-AL001 | 25W | typ.4000 | typ.160 | Y | L1205 X W55 X H60 | 13.0kg | 10pcs |
| TS-LM12-50AN1-AL001 | 50W | typ.8000 | typ.160 | Y | L1205 X W55 X H60 | 13.0kg | 10pcs |
| TS-LM15-32AN1-AL001 | 32W | typ.5100 | typ.160 | Y | L1505 X W55 X H60 | 16.0kg | 10pcs |
| TS-LM15-64AN1-AL001 | 64W | typ.10250 | typ.160 | Y | L1505 X W55 X H60 | 16.0kg | 10pcs |

▶ Frosted Module

| Order Code | Wattage | Lumen | LM/W | Flicker Free | Dimension (mm) | GW/CTN | QTY/CTN |
|---------------------|---------|----------|---------|--------------|-------------------|--------|---------|
| TS-LM12-25PN1-AF001 | 25W | typ.3250 | typ.130 | Y | L1205 X W55 X H60 | 12.0kg | 10pcs |
| TS-LM12-50PN1-AF001 | 50W | typ.6500 | typ.130 | Y | L1205 X W55 X H60 | 12.0kg | 10pcs |
| TS-LM15-32PN1-AF001 | 32W | typ.4150 | typ.130 | Y | L1505 X W55 X H60 | 15.0kg | 10pcs |
| TS-LM15-64PN1-AF001 | 64W | typ.8300 | typ.130 | Y | L1505 X W55 X H60 | 15.0kg | 10pcs |

▶ Gentle Module (Low glare UGR<22)

| Order Code | Wattage | Lumen | LM/W | Flicker Free | Dimension (mm) | GW/CTN | QTY/CTN |
|---------------------|---------|----------|---------|--------------|-------------------|--------|---------|
| TS-LM12-25SN1-AG001 | 25W | typ.3000 | typ.120 | Y | L1205 X W55 X H60 | 12.0kg | 10pcs |
| TS-LM12-50SN1-AG001 | 50W | typ.6000 | typ.120 | Y | L1205 X W55 X H60 | 12.0kg | 10pcs |
| TS-LM15-32SN1-AG001 | 32W | typ.3850 | typ.120 | Y | L1505 X W55 X H60 | 15.0kg | 10pcs |
| TS-LM15-64SN1-AG001 | 64W | typ.7650 | typ.120 | Y | L1505 X W55 X H60 | 15.0kg | 10pcs |

▶ Narrow Module (80°)

| Order Code | Wattage | Lumen | LM/W | Flicker Free | Dimension (mm) | GW/CTN | QTY/CTN |
|---------------------|---------|----------|---------|--------------|-------------------|--------|---------|
| TS-LM12-25AN1-AN001 | 25W | typ.3250 | typ.130 | Y | L1205 X W55 X H46 | 12.0kg | 10pcs |
| TS-LM12-50AN1-AN001 | 50W | typ.6500 | typ.130 | Y | L1205 X W55 X H46 | 12.0kg | 10pcs |
| TS-LM15-32AN1-AN001 | 32W | typ.4150 | typ.130 | Y | L1505 X W55 X H46 | 15.0kg | 10pcs |
| TS-LM15-64AN1-AN001 | 64W | typ.8300 | typ.130 | Y | L1505 X W55 X H46 | 15.0kg | 10pcs |

▶ T8 Module (120°)

| Order Code | Rated Power | Lumen | LM/W | Flicker Free | Dimension (mm) | GW/CTN | QTY/CTN |
|---------------------|-------------|----------|---------|--------------|-------------------|--------|---------|
| TS-LM12-25PN1-AT001 | 25W | typ.3000 | typ.120 | Y | L1205 X W55 X H54 | 12.0kg | 10pcs |
| TS-LM12-50PN1-AT001 | 50W | typ.6000 | typ.120 | Y | L1205 X W55 X H54 | 12.0kg | 10pcs |
| TS-LM15-32PN1-AT001 | 32W | typ.3850 | typ.120 | Y | L1505 X W55 X H54 | 15.0kg | 10pcs |
| TS-LM15-64PN1-AT001 | 64W | typ.7650 | typ.120 | Y | L1505 X W55 X H54 | 15.0kg | 10pcs |



Retro Flex Lighting module

- >Retro Flex light module is an own designed linear trunk system lighting module which can be used to replace various traditional lighting modules of different brands, such as Philips, Trilux, Zumtobel, Siteco, Ridi, and many more. Its flexible and self-centering clamp system allows this module to be installed on a wide variety of trunks.
- >Retro Flex comes with its own set of pre-wired connections wires, making it completely independent from the trunk it is installed on. The WAGO connection terminal provides a quick and easy way to connect module after module. Both the 5-wire on/off version as well as the 7-wire dimming version, come with a 400V rated 3-phase line switcher which allows creating various installation scenarios.
- >The driver not only has the wattage adjustable / Dimming function, But also have the CLO function after long time operation.
- > Retro flex light module include the PC cover and honeycomb version. The honeycomb version provides a perfectly homogeneous light distribution in high and low ceiling area.
- >For situation where no pre-installed trunk system is available, we of course offer our own trunk rail system to facilitate any need for a complete and flexible trunking system.

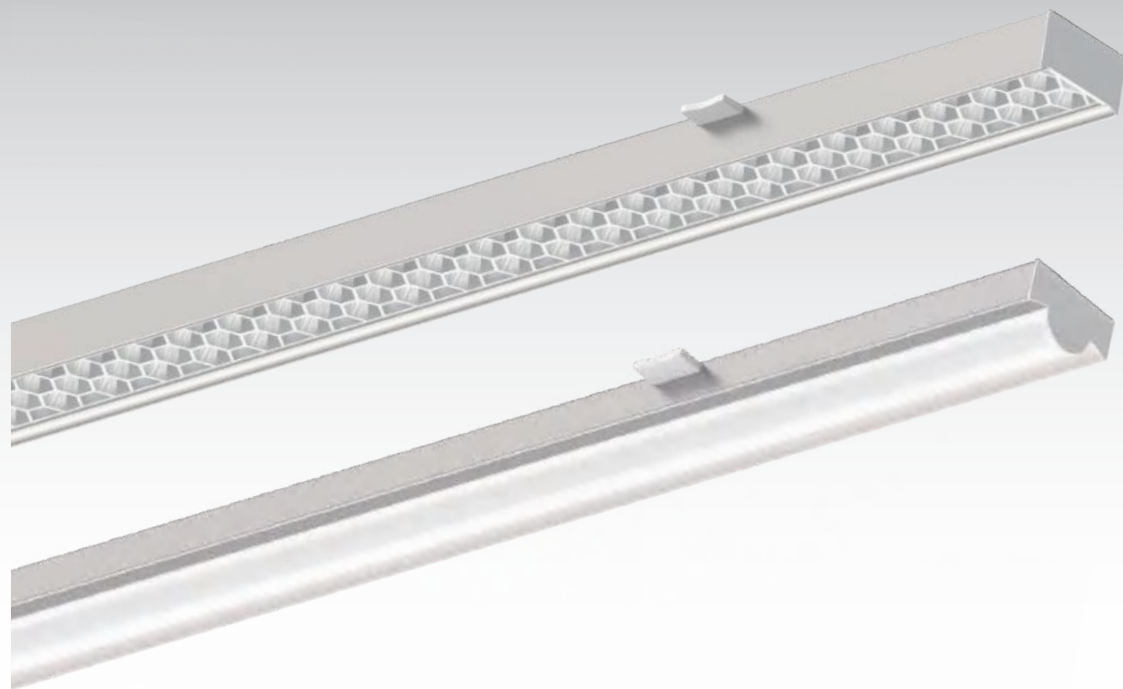

Retro Flex

PC / Honeycomb

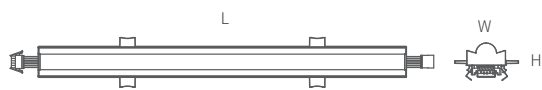

Retro flex lighting module include pre-wired PC cover (160lm/W) module and honeycomb (125lm/W) module, CLO function makes 7 years warranty, 25-75W adjustable makes stock easy to handle, Tri color suitable for different applications.

Features

- > Up to 160lm/W@12000LM
- > UGR<19 (honeycomb cover)
- > 400V Switcher for 3-phase AC
- > 5/7 pre-wired system with CLO function
- > Click-Slide system allows the module to be mounted on variety of trunks
- > Tool free installation at MAX 200M multiple link
- > 7 years warranty

CCT

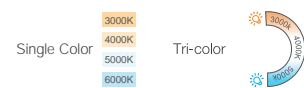

Function



Electrical Parameters



Photometric Parameters



Wiring



Finish



Data Sheet

| Order Code | Rated Power | Lumen | LM/W | Flicker Free | Dimension (mm) | GW/CTN | QTY/CTN |
|---------------------|-------------|----------------|---------|--------------|--------------------|--------|---------|
| RM05-75DTR-P2N1F-00 | 25-75W | typ.4000-12000 | typ.160 | Y | L1526 X W106 X H88 | 21.5kg | 8pcs |
| RM05-75DTR-H6N1F-00 | 25-75W | typ.3000-9000 | typ.120 | Y | L1526 X W106 X H88 | 16.5kg | 8pcs |
| RM05-75DTR-H9N1F-00 | 25-75W | typ.3000-9000 | typ.120 | Y | L1526 X W106 X H88 | 16.5kg | 8pcs |

Traditional trunk complete with

Complete with various brands traditional trunks

Width: Max 68mm, Min 42mm

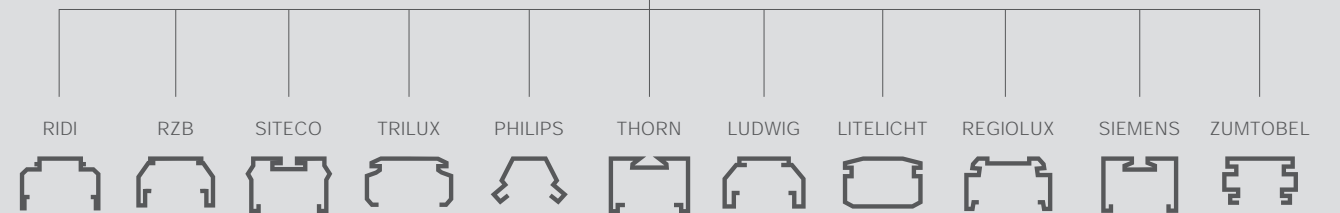

Trunk rail and Blank cover (Toppo Standard)

For the applications have no the traditional trunk or the new buildings. Toppo can provide the standard trunk for the retro flex lighting module. And also, we provide the blank cover for the additional balance length for the installation.

Trunk Rail

| Product Picture | Order Code | Product Name | Dimension (mm) | Dimension drawing |
|-----------------|------------|------------------------|---------------------|-------------------|
| | RM-TR05-00 | 5ft-150CM/ Trunk Rail | L1527 X W64.5 X H50 | |
| | RM-TR10-00 | 10ft-300CM/ Trunk Rail | L3027 X W64.5 X H50 | |

Blank cover

| Product Picture | Order Code | Product Name | Dimension (mm) | Dimension drawing |
|-----------------|------------|-----------------------|---------------------|-------------------|
| | RM-BC01-00 | 1ft-30CM/Blank Cover | L327 X W64.5 X H37 | |
| | RM-BC04-00 | 4ft-120CM/Blank Cover | L1227 X W64.5 X H37 | |
| | RM-BC05-00 | 5ft-150CM/Blank Cover | L1527 X W64.5 X H37 | |

Product Design | Profile

- 25-75W**
 Each universal module enable tool-free 7-level power regulation via DIP switch: 25W-35W-40W-45W-55W-65W-75W.
- CLO**
 The newly developed LED driver regulates the luminous flux intelligently and automatically. In this way is constant over the entire service life Light level guaranteed and economical operation secured.
- The unique soft start technology reduces high inrush currents and saves money. It protects electrical components and thus extends the operating time and service life.
- CCT Switch enables the selection the desired color temperature (3000 K - 4000 K - 5000 K) simply select using the DIP switch.
- WW NW CW**
 Tool-free phase selection, this saves you a rewiring and thus valuable time.
- ▲L1 ▲L2 ▲L3**
 The 400V / 3-phase AC switcher makes the Retro Flex Module can be max 200 meters multiple linking.

Product Design | Profile

- Safety rope hanging board
- Safety rope hanging board
- Smart click-slide installation clips for renovation or conversion of all common T5 and T8 light line systems.
- Easy assembly / disassembly Flexible arrangement in the mounting rail, enables a 1-person conversion.
- Male and female connector quick connect, tool free, save valuable time during of assembly
- Male and female connector quick connect, tool free, save valuable time during of assembly



Pro-Line

Max 100 Meters Multiple Tool-free Installation

- > Pro-Line is an own designed multiple link led linear light system, adopts 5 different light modules: Weston UGR light module, Frosted light module, T8 light module, Lens light module and Narrow light module, which provide the optimized lighting solution for industrial and commercial applications, such as: Supermarket, Shopping Malls, Offices, Factories, Warehouse, etc
- > Pro-Line Slim Batten delivers a tool free magnet installation which can be max 100 meters multiple link, 600mm/1200mm/1500mm/1800mm size as options.
- > Loop in and out, fast connector design for easier wire connection, easy installation and maintenance, widely installation way: surface mounted / suspended / magnet installation.

Pro-Line Installation/connection method

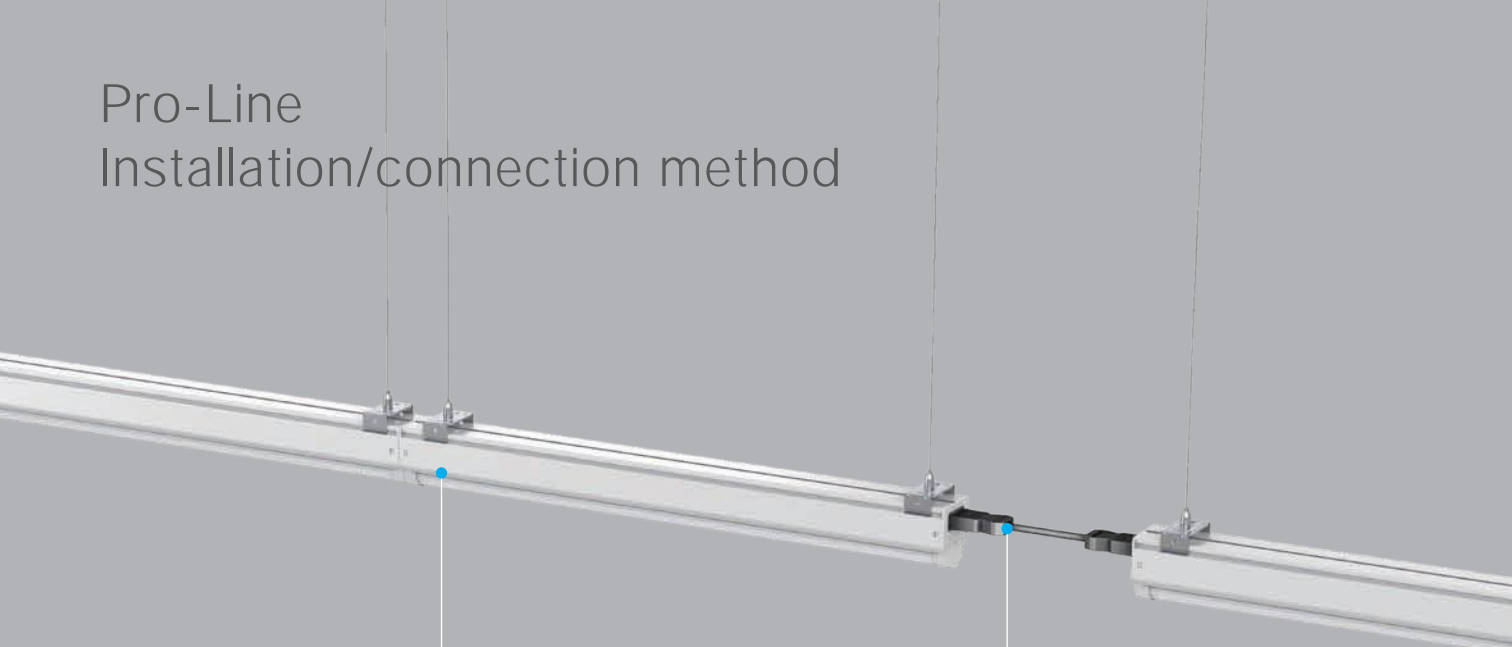

Quick Connect Clip

Fast Connector

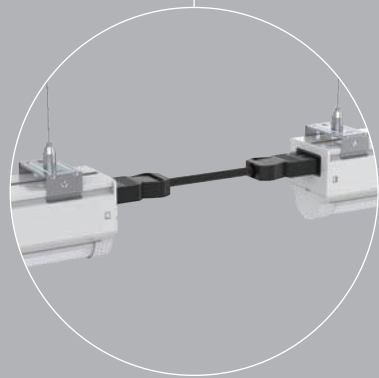

Installation

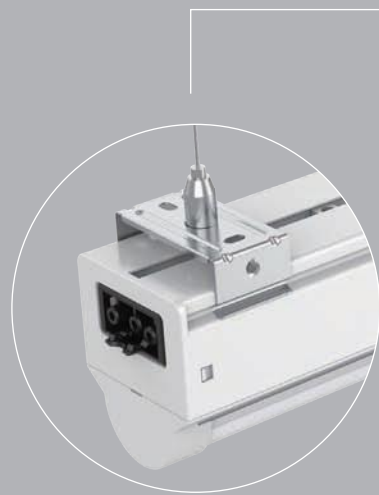

Suspension

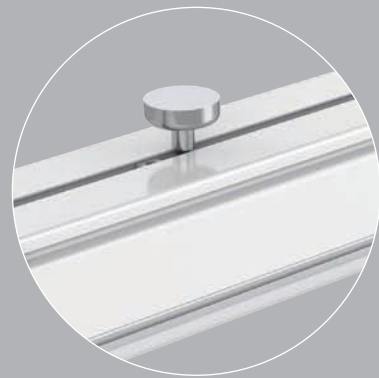

Magnet tool free installation



Surface Mounting

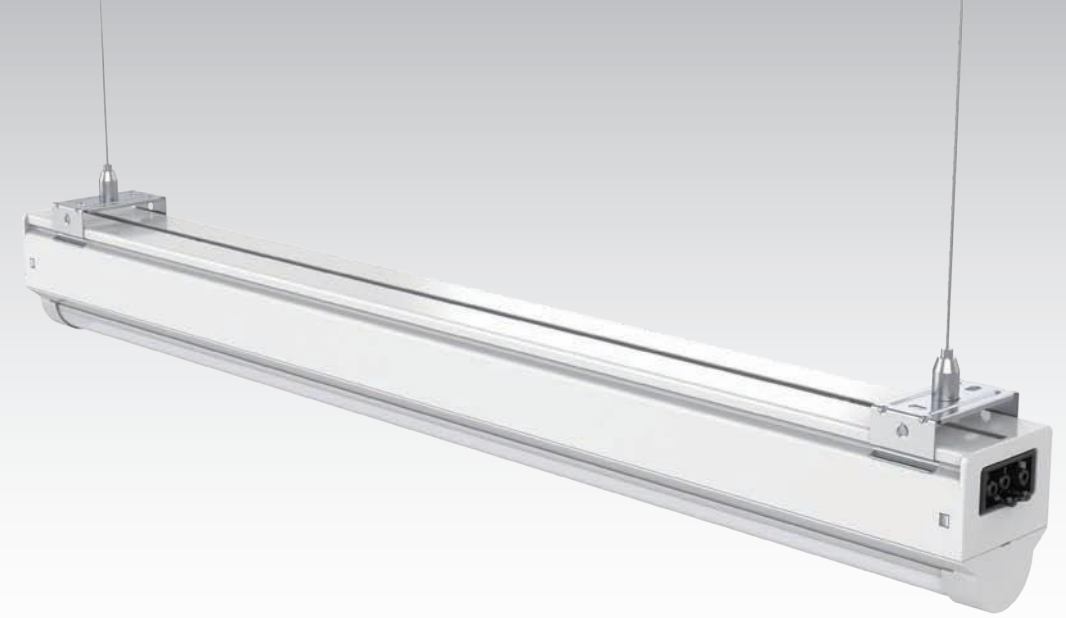

Pro-Line

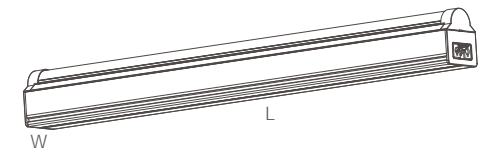

Pro-Line is a complete LED solutions designed for shelf led lighting by Magnet tool free installation. And it's also widely used in the office / commercial / industrial / education applications.

The Pro-Line can be connected through the end by quick Wieland connector. This allows end to end continuous tool free installation.

► Features

- > Up to 160lm/W
- > Quick Wieland Connector For Multiple Link
- > Magnet tool-free Installation / Surface Mounted / Suspension
- > 5 years warranty

► CCT

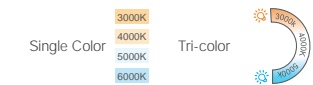

► Function



► Electrical Parameters



► Photometric Parameters



► Wiring



► Finish



► Data Sheet

| Order Code | Rated Power | Lumen | LM/W | Flicker Free | Dimension (mm) | GW/CTN | QTY/CTN |
|----------------------|-------------|----------|---------|--------------|-------------------|--------|---------|
| BT02-10TN1-PTN1E-002 | 10W | typ.1600 | typ.160 | Y | L600 X W55 X H58 | 6.4kg | 10pcs |
| BT04-17TN1-PTN1E-002 | 17W | typ.2720 | typ.160 | Y | L1200 X W55 X H58 | 11.3kg | 10pcs |
| BT04-32TN1-PTN1E-002 | 32W | typ.5120 | typ.160 | Y | L1200 X W55 X H58 | 11.3kg | 10pcs |
| BT05-28TN1-PTN1E-002 | 28W | typ.4480 | typ.160 | Y | L1500 X W55 X H58 | 14.5kg | 10pcs |
| BT05-56TN1-PTN1E-002 | 56W | typ.8960 | typ.160 | Y | L1500 X W55 X H58 | 14.5kg | 10pcs |
| BT06-32TN1-PTN1E-002 | 32W | typ.5120 | typ.160 | Y | L1800 X W55 X H58 | 17.8kg | 10pcs |
| BT06-62TN1-PTN1E-002 | 62W | typ.9920 | typ.160 | Y | L1800 X W55 X H58 | 17.8kg | 10pcs |

► Lens Module (30°/60°/90°/LR25 Optional)

| Order Code | Wattage | Lumen | LM/W | Flicker Free | Dimension (mm) | GW/CTN | QTY/CTN |
|----------------------|---------|----------|---------|--------------|---------------------|--------|---------|
| BT02-10DN1-PLN1E-092 | 10W | typ.1600 | typ.160 | Y | L600 X W55 X H63.5 | 6.8kg | 8pcs |
| BT04-17DN1-PLN1E-092 | 17W | typ.2720 | typ.160 | Y | L1200 X W55 X H63.5 | 12.5kg | 8pcs |
| BT04-32DN1-PLN1E-092 | 32W | typ.5120 | typ.160 | Y | L1200 X W55 X H63.5 | 12.5kg | 8pcs |
| BT05-28DN1-PLN1E-092 | 28W | typ.4480 | typ.160 | Y | L1500 X W55 X H63.5 | 15.5kg | 8pcs |
| BT05-56DN1-PLN1E-092 | 56W | typ.8960 | typ.160 | Y | L1500 X W55 X H63.5 | 15.5kg | 8pcs |
| BT06-32DN1-PLN1E-092 | 32W | typ.5120 | typ.160 | Y | L1800 X W55 X H63.5 | 18.0kg | 8pcs |
| BT06-62DN1-PLN1E-092 | 62W | typ.9920 | typ.160 | Y | L1800 X W55 X H63.5 | 18.0kg | 8pcs |

► Frosted Module

| Order Code | Rated Power | Lumen | LM/W | Flicker Free | Dimension (mm) | GW/CTN | QTY/CTN |
|----------------------|-------------|----------|---------|--------------|---------------------|--------|---------|
| BT02-10DN1-PFN1E-002 | 10W | typ.1600 | typ.160 | Y | L600 X W55 X H63.5 | 5.8kg | 8pcs |
| BT04-17DN1-PFN1E-002 | 17W | typ.2720 | typ.160 | Y | L1200 X W55 X H63.5 | 11.5kg | 8pcs |
| BT04-32DN1-PFN1E-002 | 32W | typ.5120 | typ.160 | Y | L1200 X W55 X H63.5 | 11.5kg | 8pcs |
| BT05-28DN1-PFN1E-002 | 28W | typ.4480 | typ.160 | Y | L1500 X W55 X H63.5 | 14.5kg | 8pcs |
| BT05-56DN1-PFN1E-002 | 56W | typ.8960 | typ.160 | Y | L1500 X W55 X H63.5 | 14.5kg | 8pcs |
| BT06-32DN1-PFN1E-002 | 32W | typ.5120 | typ.160 | Y | L1800 X W55 X H63.5 | 17.0kg | 8pcs |
| BT06-62DN1-PFN1E-002 | 62W | typ.9920 | typ.160 | Y | L1800 X W55 X H63.5 | 17.0kg | 8pcs |

► Weston Module (Low glare UGR<22)

| Order Code | Rated Power | Lumen | LM/W | Flicker Free | Dimension (mm) | GW/CTN | QTY/CTN |
|----------------------|-------------|----------|---------|--------------|---------------------|--------|---------|
| BT02-10KN1-PWN1E-002 | 10W | typ.1200 | typ.120 | Y | L605 X W55 X H63.5 | 6.0kg | 8pcs |
| BT04-17KN1-PWN1E-002 | 17W | typ.2040 | typ.120 | Y | L1205 X W55 X H63.5 | 11.5kg | 8pcs |
| BT04-34KN1-PWN1E-002 | 34W | typ.4080 | typ.120 | Y | L1205 X W55 X H63.5 | 11.5kg | 8pcs |
| BT05-22KN1-PWN1E-002 | 22W | typ.2640 | typ.120 | Y | L1505 X W55 X H63.5 | 14.5kg | 8pcs |
| BT05-40KN1-PWN1E-002 | 40W | typ.4800 | typ.120 | Y | L1505 X W55 X H63.5 | 14.5kg | 8pcs |
| BT06-27KN1-PWN1E-002 | 27W | typ.3240 | typ.120 | Y | L1805 X W55 X H63.5 | 17.0kg | 8pcs |
| BT06-50KN1-PWN1E-002 | 50W | typ.6000 | typ.120 | Y | L1805 X W55 X H63.5 | 17.0kg | 8pcs |

► Narrow Module (80°)

| Order Code | Rated Power | Lumen | LM/W | Flicker Free | Dimension (mm) | GW/CTN | QTY/CTN |
|----------------------|-------------|-----------|---------|--------------|-------------------|--------|---------|
| BT02-10DN1-PNN1E-002 | 10W | typ.1600 | typ.160 | Y | L605 X W55 X H50 | 5.7kg | 10pcs |
| BT04-17DN1-PNN1E-002 | 17W | typ.2720 | typ.160 | Y | L1200 X W55 X H50 | 11.3kg | 10pcs |
| BT04-32DN1-PNN1E-002 | 32W | typ.5120 | typ.160 | Y | L1200 X W55 X H50 | 11.3kg | 10pcs |
| BT05-28DN1-PNN1E-002 | 28W | typ.4480 | typ.160 | Y | L1500 X W55 X H50 | 14.5kg | 10pcs |
| BT05-56DN1-PNN1E-002 | 56W | typ.8960 | typ.160 | Y | L1500 X W55 X H50 | 14.5kg | 10pcs |
| BT06-32DN1-PNN1E-002 | 32W | typ.5120 | typ.160 | Y | L1800 X W55 X H50 | 17.8kg | 10pcs |
| BT06-62DN1-PNN1E-002 | 62W | typ.9920 | typ.160 | Y | L1800 X W55 X H50 | 17.8kg | 10pcs |
| BT06-72DN1-PNN1E-002 | 72W | typ.11520 | typ.160 | Y | L1800 X W55 X H50 | 17.8kg | 10pcs |

► Accessory

| Order Code | Product name |
|------------------------|--------------------------------|
| ASS-WIR-F318FU-1500-00 | 1500mm EU Plug Connector |
| ASS-WIR-F318FU-2000-04 | 2000mm EU Plug Connector |
| ASS-WIR-F318FU-3000-00 | 3000mm EU Plug Connector |
| ASS-WIR-F318FU-0300-01 | 300mm Male & Female Connector |
| ASS-WIR-F318FU-0900-01 | 900mm Male & Female Connector |
| ASS-WIR-F318FU-1500-01 | 1500mm Male & Female Connector |
| ASS-WIR-F315FU-2000-00 | 2000mm Male & Female Connector |



Pro-Line Light module



Gentle Module



Frosted Module



Lens Module



Narrow Module



T8 Module



Tri-proof Lights

/Series/

- >The aluminum tri-proof lights are a new modern design which with more function options and up to 160lm/W.
- >All of aluminum tri-proof lights are IP65 and IK10 protected, the different options make the clients use the aluminum tri-proof lights on different applications, such as: Car parks, Factories, ect.



Prime Tri-proof

Aluminum+PC | 160lm/w

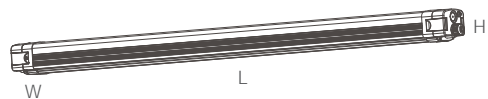

Prime tri-proof is a tool free multi connected fitting which with various of function options as be showed on this catalogue.

The excellent heating sink, function options and multi connecting make it has a wide range of used in different applications.

► Features

- > Quick snap end caps for easy installation
- > CCT & Wattage adjustable on end cap
- > 5 wires 3 phase for more quantity linkable
- > 160lm/W high lumen efficacy
- > Single or linkable installation
- > 5 years warranty

► Data Sheet

| Order Code | Rated Power | Lumen | LM/W | Flicker Free | Dimension (mm) | GW/CTN | QTY/CTN |
|----------------------|-------------|-----------|---------|--------------|-------------------|--------|---------|
| TR02-22TN1-PFN1E-001 | 22W | typ.3500 | typ.160 | Y | L625 X W85 X H73 | 6.5kg | 4pcs |
| TR04-40TN1-PFN1E-001 | 40W | typ.6400 | typ.160 | Y | L1200 X W85 X H73 | 9.5kg | 4pcs |
| TR04-60TN1-PFN1E-001 | 60W | typ.9600 | typ.160 | Y | L1200 X W85 X H73 | 9.5kg | 4pcs |
| TR05-40TN1-PFN1E-001 | 40W | typ.6400 | typ.160 | Y | L1500 X W85 X H73 | 12.5kg | 4pcs |
| TR05-60TN1-PFN1E-001 | 60W | typ.9600 | typ.160 | Y | L1500 X W85 X H73 | 12.5kg | 4pcs |
| TR08-1ATN1-PFN1E-001 | 100W | typ.16000 | typ.160 | Y | L2400 X W85 X H73 | 19.0kg | 4pcs |

► CCT

Single Color: 3000K, 4000K, 5000K, 6000K
Tri-color: 2700K, 3000K, 3500K, 4000K, 4500K, 5000K, 5500K, 6000K

► Function

ON/OFF, 1-10V Dimming, DALI, MS, Light Sensor, PIR, Emergency

► Electrical Parameters

AC 200-240V, PF ≥0.95, THD <15%, Flicker Free

► Photometric Parameters

120 LM/W, 140 LM/W, 160 LM/W
CRI>80 SDCM <5, LM79 TM-21, ERP2.0

► Wiring

Single wiring, Double wiring, 3wires 3Phase, 5wires 3Phase, 7wires 3Phase

► IP/IK

IP65, IK10



IP65
IK10
UP to 160LM/W

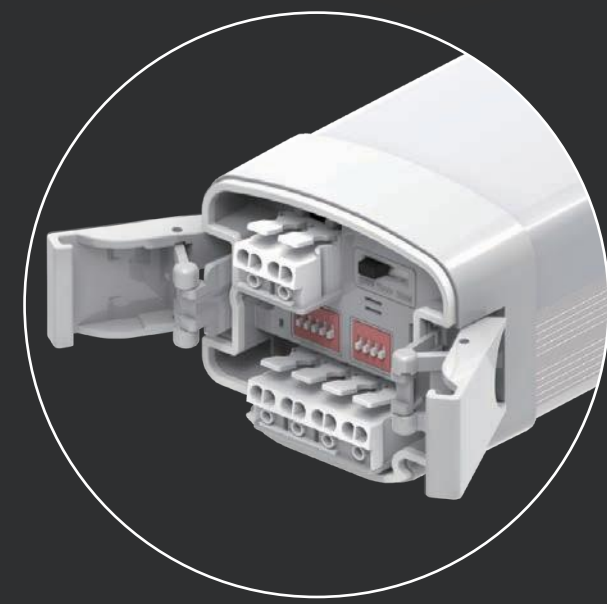

Function options

- > CCT switch
- > Wattage switch
- > EM testing switch
- > MS switch
- > 3 phase switch
- > 3/5/7 wires terminal



Deco Tri-proof

Aluminum+PC | 160lm/w

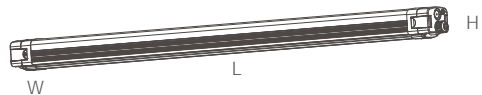

Deco tri-proof is new design which use the gear tray to realize the function options. The gear tray is taken out from the end cap.
The excellent heating sink, function options and multi connecting make it has a wide range of used in different applications.

► Features

- > Quick snap end caps for easy installation
- > Easy for LED driver replacement
- > CCT & Wattage adjustable
- > 160lm/W with high lumen efficacy
- > Single or linkable installation
- > 5 years warranty

► Data Sheet

| Order Code | Rated Power | Lumen | LM/W | Flicker Free | Dimension (mm) | GW/CTN | QTY/CTN |
|----------------------|-------------|-----------|---------|--------------|-------------------|--------|---------|
| TR02-22TN1-DFN1E-001 | 22W | typ.3500 | typ.160 | Y | L625 X W85 X H73 | 6.5kg | 4pcs |
| TR04-40TN1-DFN1E-001 | 40W | typ.6400 | typ.160 | Y | L1200 X W85 X H73 | 9.5kg | 4pcs |
| TR04-60TN1-DFN1E-001 | 60W | typ.9600 | typ.160 | Y | L1200 X W85 X H73 | 9.5kg | 4pcs |
| TR05-40TN1-DFN1E-001 | 40W | typ.6400 | typ.160 | Y | L1500 X W85 X H73 | 12.5kg | 4pcs |
| TR05-60TN1-DFN1E-001 | 60W | typ.9600 | typ.160 | Y | L1500 X W85 X H73 | 12.5kg | 4pcs |
| TR08-1ATN1-DFN1E-001 | 100W | typ.16000 | typ.160 | Y | L2400 X W85 X H73 | 19.0kg | 4pcs |

► CCT

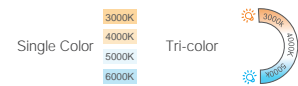

► Function



► Electrical Parameters



► Photometric Parameters



► Wiring



► IP/IK

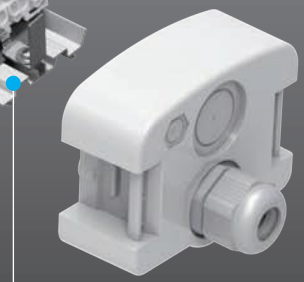
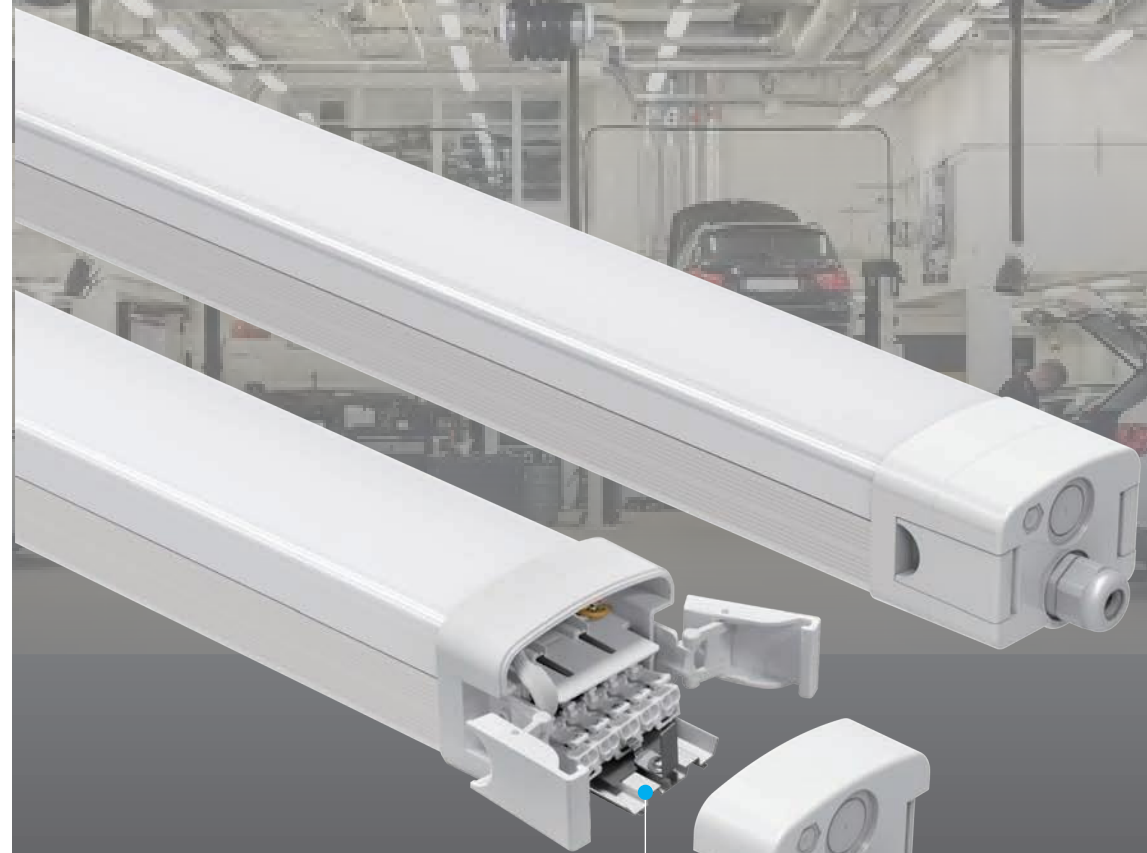

Function gear tray



Basic Tri-proof

Aluminum+PC | 160lm/w

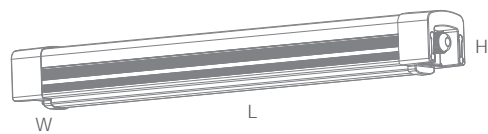

Basic Tri-proof light which were widely used on warehouses, factories, car parks, sports facilities etc. Outdoor, indoor commercial & industrial applications.

The Aluminum casing provides excellent heating dissipation, The high technology SMD2835 provide a more higher lumen output, up to 160lm/W.

Features

- > IP65/IK10 approval
- > Single or multiple link
- > 5 years warranty

Data Sheet

| Order Code | Rated Power | Lumen | LM/W | Flicker Free | Dimension (mm) | GW/CTN | QTY/CTN |
|----------------------|-------------|-----------|---------|--------------|-------------------|--------|---------|
| TR02-22TN1-BFN1E-001 | 22W | typ.3500 | typ.160 | Y | L625 X W85 X H78 | 7.8kg | 4pcs |
| TR04-40TN1-BFN1E-001 | 40W | typ.6400 | typ.160 | Y | L1225 X W85 X H78 | 12.5kg | 4pcs |
| TR04-60TN1-BFN1E-001 | 60W | typ.9600 | typ.160 | Y | L1225 X W85 X H78 | 12.5kg | 4pcs |
| TR05-40TN1-BFN1E-001 | 40W | typ.6400 | typ.160 | Y | L1525 X W85 X H78 | 14.5kg | 4pcs |
| TR05-60TN1-BFN1E-001 | 60W | typ.9600 | typ.160 | Y | L1525 X W85 X H78 | 14.5kg | 4pcs |
| TR08-1ATN1-BFN1E-001 | 100W | typ.16000 | typ.160 | Y | L2425 X W85 X H78 | 24.0kg | 4pcs |

- ▶ CCT Single Color **3000K** 4000K 5000K 6000K
- ▶ Function ON/OFF, 1-10V Dimming, DALI, PIR
- ▶ Electrical Parameters AC 200-240V, PF ≥0.95, THD <15%, Flicker Free
- ▶ Photometric Parameters 120 LM/W, 140 LM/W, 160 LM/W, CRI>80 SDCM <5, LM79 TM-21, ERP2.0
- ▶ Wiring Single wiring, Double wiring, 3wires 3Phase, 5wires 3Phase
- ▶ IP/IK IP65, IK10



Tubar Light

PMMA / PC

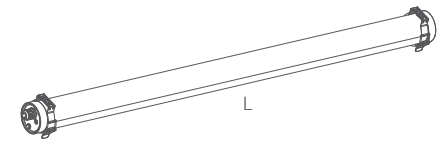

IP69K Tubar light is an ideal solution for chemical cleaning, car washing, food processing and poultry lighting etc. industrial applications.

PMMA case for NH₃-Anti Corrosion Resistance, PC Housing for UV Resistance. The high technology SMD2835 provide a more higher lumen output.

Features

- > IP69K / IK10 Protection
- > Single or multiple link
- > 5 years warranty

Data Sheet

| Order Code | Rated Power | Lumen | LM/W | Flicker Free | Dimension (mm) | GW/CTN | QTY/CTN |
|----------------------|-------------|----------|---------|--------------|----------------|--------|---------|
| TU02-22TN1-AMN1E-001 | 22W | typ.3050 | typ.140 | Y | L600 X D78 | 7.8kg | 4pcs |
| TU04-40TN1-AMN1E-001 | 40W | typ.5500 | typ.140 | Y | L1200 X D78 | 12.5kg | 4pcs |
| TU04-60TN1-AMN1E-001 | 60W | typ.8400 | typ.140 | Y | L1200 X D78 | 12.5kg | 4pcs |
| TU05-60TN1-AMN1E-001 | 60W | typ.8400 | typ.140 | Y | L1500 X D78 | 14.5kg | 4pcs |

- ▶ CCT Single Color **3000K** 4000K 5000K 6000K
- ▶ Function ON/OFF, 1-10V Dimming, DALI
- ▶ Electrical Parameters AC 200-240V, PF ≥0.95, THD <15%, Flicker Free
- ▶ Photometric Parameters 120 LM/W, 140 LM/W, CRI>80 SDCM <5, LM79 TM-21, ERP2.0
- ▶ Wiring Single wiring, Double wiring
- ▶ Material PC, PMMA
- ▶ IP/IK IP69K, IK10



NCF Luminaires

/Series/

- > The NCF luminaires were designed to replace the traditional single and twins fluorescent fitting with IP65 and IK08 protected.
- > NCF luminaires offer a higher lumen output at 120/140/160 lm/W.
- > The different function options make the clients use the NCF on different applications, such as: Car parks, Factories, Warehouses, ect.

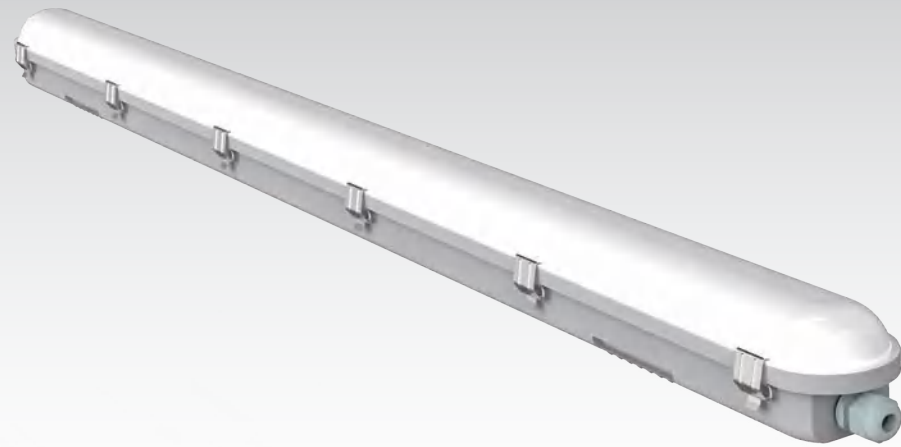

Single NCF

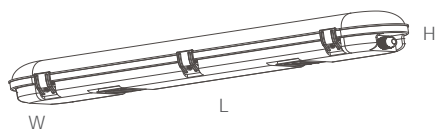

Single NCF fitting is a new design to replace the traditional fluorescent fitting. The different lengths are available. Waterproof, Dust-proof, Corrosion-Proof, is the basic features of the luminaires. Exclusive Quick-fit design for faster installation.

► Features

- > Easy Installation with fast connection design
- > End or rear cable entry
- > IP65 Rating, High impact IK08
- > Single installation or linkable
- > 5 years warranty

► Data Sheet

| Order Code | Rated Power | Lumen | LM/W | Flicker Free | Dimension (mm) | GW/CTN | QTY/CTN |
|----------------------|-------------|----------|---------|--------------|-------------------|--------|---------|
| TR02-20AN1-SFN1E-001 | 20W | typ.2800 | typ.140 | Y | L600 X W80 X H75 | 6.2kg | 6pcs |
| TR04-30AN1-SFN1E-001 | 30W | typ.4200 | typ.140 | Y | L1200 X W80 X H75 | 11.2kg | 6pcs |
| TR05-25AN1-SFN1E-001 | 25W | typ.3500 | typ.140 | Y | L1500 X W80 X H75 | 14.2kg | 6pcs |
| TR05-50AN1-SFN1E-001 | 50W | typ.7000 | typ.140 | Y | L1500 X W80 X H75 | 14.2kg | 6pcs |
| TR06-30AN1-SFN1E-001 | 30W | typ.4200 | typ.140 | Y | L1800 X W80 X H75 | 17.5kg | 6pcs |
| TR06-50AN1-SFN1E-001 | 50W | typ.7000 | typ.140 | Y | L1800 X W80 X H75 | 17.5kg | 6pcs |



Twins NCF

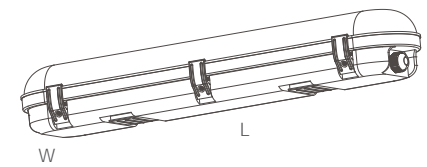

Twins NCF fitting is a new design to replace the traditional fluorescent fitting. The different lengths are available. Waterproof, Dust-proof, Corrosion-Proof, is the basic features of the luminaires. Exclusive Quick-fit design for faster installation.

► Features

- > Easy Installation with fast connection design
- > End or rear cable entry
- > IP65 Rating, High impact IK08
- > Single installation or linkable
- > 5 years warranty

► Data Sheet

| Order Code | Rated Power | Lumen | LM/W | Flicker Free | Dimension (mm) | GW/CTN | QTY/CTN |
|----------------------|-------------|-----------|---------|--------------|--------------------|--------|---------|
| TR02-20AN1-AFN1E-001 | 20W | typ.2800 | typ.140 | Y | L600 X W125 X H88 | 8.64kg | 6pcs |
| TR04-40AN1-AFN1E-001 | 40W | typ.5600 | typ.140 | Y | L1200 X W125 X H88 | 16.0kg | 6pcs |
| TR05-50AN1-AFN1E-001 | 50W | typ.7000 | typ.140 | Y | L1500 X W125 X H88 | 20.4kg | 6pcs |
| TR06-50AN1-AFN1E-001 | 50W | typ.7000 | typ.140 | Y | L1800 X W125 X H88 | 25.5kg | 6pcs |
| TR06-75AN1-AFN1E-001 | 75W | typ.10500 | typ.140 | Y | L1800 X W125 X H88 | 25.5kg | 6pcs |

► CCT

Single Color: 3000K, 4000K, 5000K, 6000K
Tri-color: 3000K, 4000K, 5000K, 6000K

► Function

ON/OFF, 1-10V Dimming, DALI, MS, Emergency

► Electrical Parameters

AC 200-240V, PF ≥0.95, THD <15%, Flicker Free

► Photometric Parameters

120 LM/W, 140 LM/W, CRI >80 SDCM <5, LM79 TM-21, ERP2.0

► Wiring

Single wiring, Double wiring

► IP/IK

IP65, IK08

► CCT

Single Color: 3000K, 4000K, 5000K, 6000K
Tri-color: 3000K, 4000K, 5000K, 6000K

► Function

ON/OFF, 1-10V Dimming, DALI, MS, Emergency

► Electrical Parameters

AC 200-240V, PF ≥0.95, THD <15%, Flicker Free

► Photometric Parameters

120 LM/W, 140 LM/W, CRI >80 SDCM <5, LM79 TM-21, ERP2.0

► Wiring

Single wiring, Double wiring

► IP/IK

IP65, IK08



Bulkhead

/Series/

- > Toppo designed a various of IP65 2D Bulkhead which be used in different applications but mainly outdoor space, create a balance light making people feel save and secure as they walk through streets, building entrances.
- > Each bulkhead has the different housing and shape design to meet various need, perfect lighting solution benefits everyone.
- > The professional case style on the bulkheads, easy opening design for easy installation make the client and more interest in Toppo bulkheads.

Bulkheads Product Family

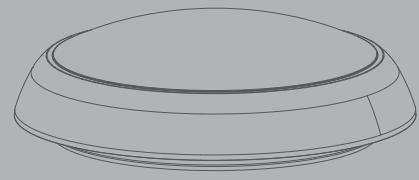

MOD

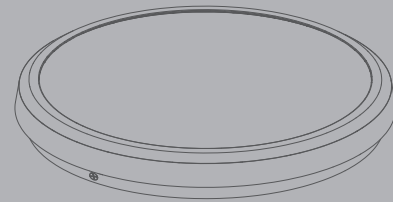

Gamma

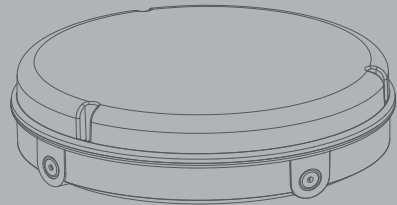

Pro

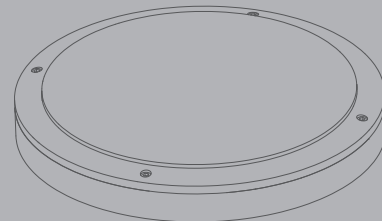

Lunar full moon

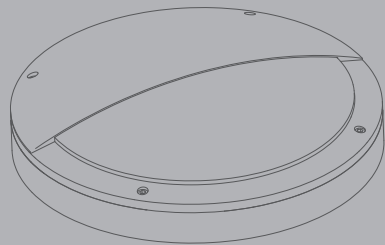

Lunar half moon

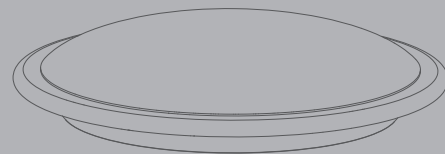

Eclips

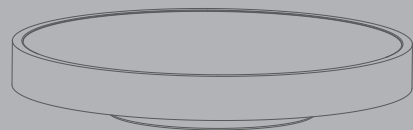

Inceptor

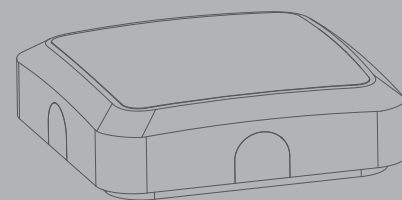

Astro

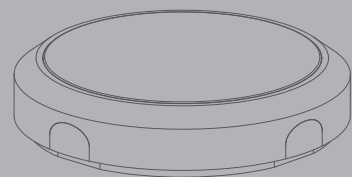

Delta

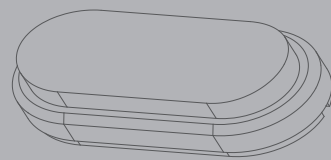

Nova



MOD Bulkheads



MOD D320

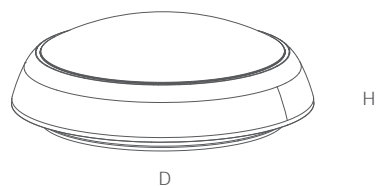

MOD-D320 bulkheads widely use to replace the traditional 2D fluorescent light. The suitable dimension and various of function options make it very popular on the market.

It can reach 120lm/W and 150lm/W to help you get a well energy saving.

Features

- > Up to 150lm/W@ 2400LM
- > IP65 waterproof
- > UV-Anti
- > Various of function options
- > Various of bezels are available
- > Warranty: 5 years

Data Sheet

| Order Code | Rated Power | Lumen | LM/W | Function | Flicker Free | Dimension (mm) | GW/CTN | QTY/CTN |
|----------------------|-------------|----------|---------|----------|--------------|----------------|--------|---------|
| BH32-12DN1-MNFXE-001 | 12W | typ.1800 | typ.150 | F1-F6 | Y | D325 X H113 | 13.0kg | 10pcs |
| BH32-16DN1-MNFXE-001 | 16W | typ.2400 | typ.150 | F1-F6 | Y | D325 X H113 | 14.0kg | 10pcs |



CCT

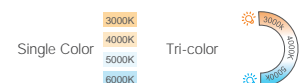

Function

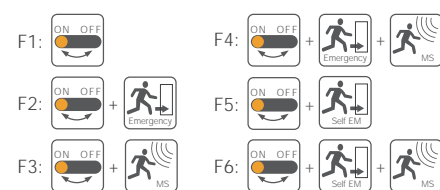

Electrical Parameters



Photometric Parameters



IP Rating



Finish



MOD-D320

Multifunctional Gear Tray

- Standard ON/OFF
- Standard+ 3h Emergency
- Standard+ Microwave
- Standard+ 3h Emergency + Microwave

Polycarbonate Cover

Made from virgin polycarbonate achieving high transmittance of 80% and vandal resistance rating of IK08



CCT Switch

enables the selection the desired CCT (3000K-4000K-5000K) simply select using the DIP switch.

Clip-in Microwave Sensor

Built-in housing for the microwave sensor which dims the drivers to achieve corridor function.

Bezels





MOD D270

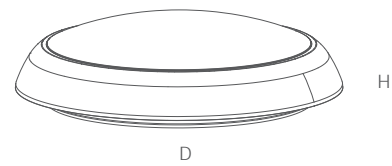

MOD-D270 bulkheads widely use to replace the traditional 2D fluorescent light. The suitable dimension and various of function options make it very popular on the market. It can reach 120lm/W to help you get a well energy saving.

► Features

- > Up to 120lm/W@1450LM
- > IP65 waterproof
- > UV-Anti
- > Various of function options
- > Warranty: 5 years

► CCT

Single Color: 3000K, 4000K, 5000K, 6000K
Tri-color: 3000K, 4000K, 5000K

► Function

F1: ON/OFF
F2: ON/OFF + Emergency
F3: ON/OFF + MS
F4: ON/OFF + Emergency + MS
F5: ON/OFF + Self EM
F6: ON/OFF + Self EM + MS

► Electrical Parameters

AC 200-240V, PF ≥0.95, THD <15%, Flicker Free

► Photometric Parameters

100 LM/W, 120 LM/W, CRI>80 SDCM <5, LM79 TM-21, ERP2.0

► IP Rating

IP65

► Finish

White, Silver, Black

► Data Sheet

| Order Code | Rated Power | Lumen | LM/W | Function | Flicker Free | Dimension (mm) | GW/CTN | QTY/CTN |
|----------------------|-------------|----------|---------|----------|--------------|----------------|--------|---------|
| BH27-10KN1-MNFXE-001 | 10W | typ.1200 | typ.120 | F1-F6 | Y | D270 X H113 | 11.0kg | 10pcs |
| BH27-12KN1-MNFXE-001 | 12W | typ.1450 | typ.120 | F1-F6 | Y | D270 X H113 | 11.0kg | 10pcs |



MOD D470

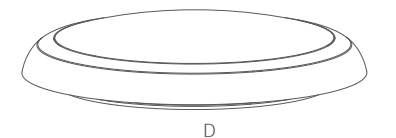

MOD-D470 bulkheads widely use to replace the traditional 2D fluorescent light. The suitable dimension and various of function options make it very popular on the market. It can reach 120lm/W and 150lm/W to help you get a well energy saving.

► Features

- > Up to 150lm/W@4500LM
- > IP65 waterproof
- > UV-Anti
- > Various of function options
- > Warranty: 5 years

► CCT

Single Color: 3000K, 4000K, 5000K, 6000K
Tri-color: 3000K, 4000K, 5000K

► Function

F1: ON/OFF
F2: ON/OFF + Emergency
F3: ON/OFF + MS
F4: ON/OFF + Emergency + MS
F5: ON/OFF + Self EM
F6: ON/OFF + Self EM + MS

► Electrical Parameters

AC 200-240V, PF ≥0.95, THD <15%, Flicker Free

► Photometric Parameters

120 LM/W, 150 LM/W, CRI>80 SDCM <5, LM79 TM-21, ERP2.0

► IP Rating

IP65

► Finish

White, Silver, Black

► Data Sheet

| Order Code | Rated Power | Lumen | LM/W | Function | Flicker Free | Dimension (mm) | GW/CTN | QTY/CTN |
|----------------------|-------------|----------|---------|----------|--------------|----------------|--------|---------|
| BH47-20DN1-MNFXE-001 | 20W | typ.3000 | typ.150 | F1-F6 | Y | D470 X H93 | 10.0kg | 5pcs |
| BH47-30DN1-MNFXE-001 | 30W | typ.4500 | typ.150 | F1-F6 | Y | D470 X H93 | 10.0kg | 5pcs |



Gamma Bulkheads

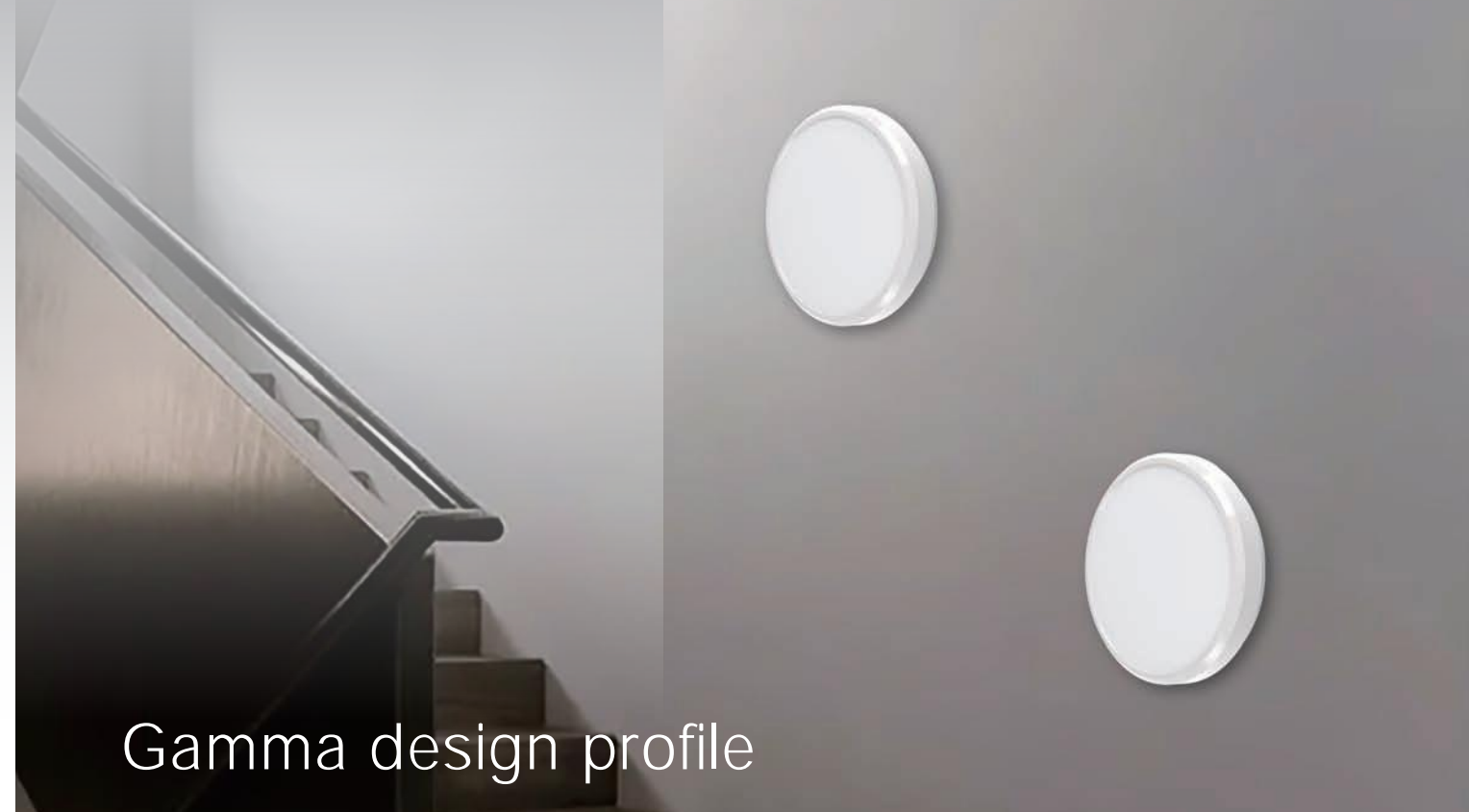

Gamma design profile

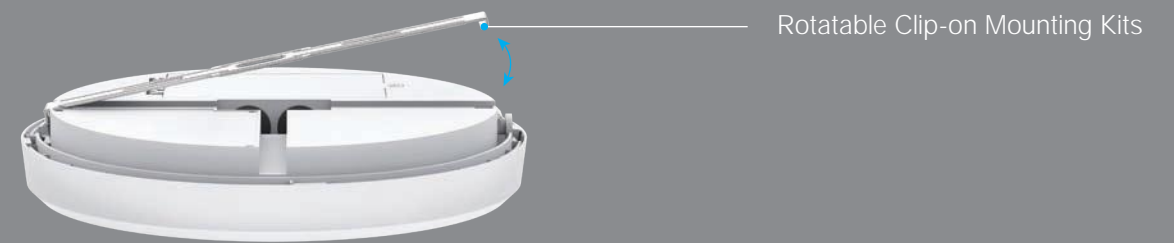

Rotatable Clip-on Mounting Kits

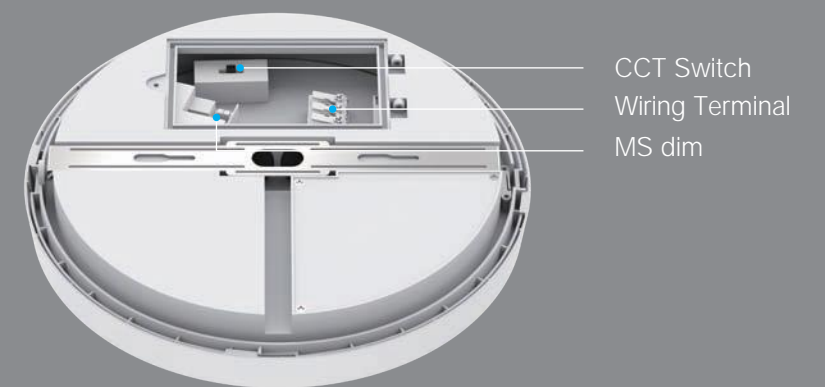

CCT Switch
Wiring Terminal
MS dim

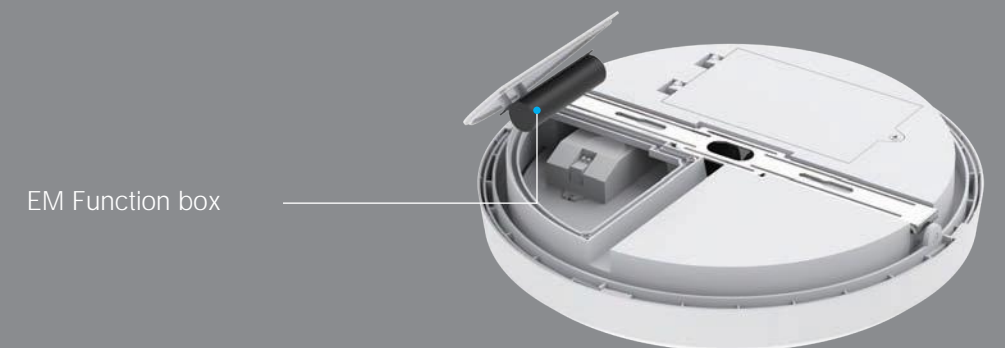

EM Function box



Gamma

D295

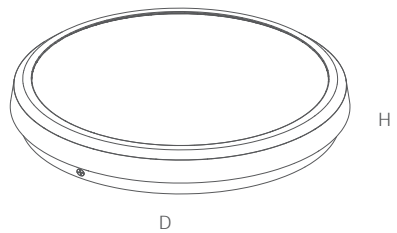

Gamma is a smart design and functional bulkhead. Use the bracket for the surface mounting installation, AC terminal and functional switch in the case make the gamma very popular.

Features

- > Up to 130lm/W@ 2100 LM >
- IP65 waterproof
- > UV-Anti
- > Various of function options
- > Warranty: 5 years

CCT

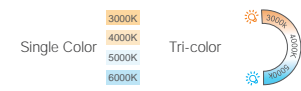

Function



Electrical Parameters



Photometric Parameters



IP Rating



Finish



Data Sheet

| Order Code | Rated Power | Lumen | LM/W | Function | Flicker Free | Dimension (mm) | GW/CTN | QTY/CTN |
|----------------------|-------------|----------|---------|----------|--------------|----------------|--------|---------|
| BH29-12PN1-GNFXE-100 | 12W | typ.1600 | typ.130 | F1-F6 | Y | D295 X H57 | 12.6kg | 10pcs |
| BH29-16PN1-GNFXE-100 | 16W | typ.2100 | typ.130 | F1-F6 | Y | D295 X H57 | 12.6kg | 10pcs |



Gamma Mini

D250

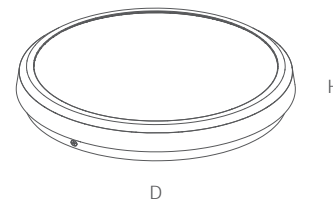

Gamma is a smart design and functional bulkhead. Use the bracket for the surface mounting installation, AC terminal and functional switch in the case make the gamma very popular.

Features

- > Up to 120lm/W@1200 LM
- IP65 waterproof
- > UV-Anti
- > Various of function options
- > Warranty: 5 years

CCT

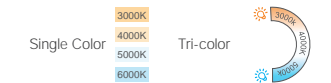

Function

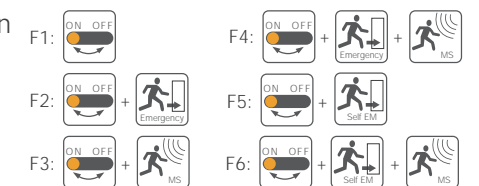

Electrical Parameters



Photometric Parameters



IP Rating



Finish



Data Sheet

| Order Code | Rated Power | Lumen | LM/W | Function | Flicker Free | Dimension (mm) | GW/CTN | QTY/CTN |
|----------------------|-------------|----------|---------|----------|--------------|----------------|--------|---------|
| BH25-10KN1-GNFXE-100 | 10W | typ.1200 | Typ.120 | F1-F6 | Y | D250 X H63 | 12.5kg | 10pcs |



Pro Bulkheads



Pro D280

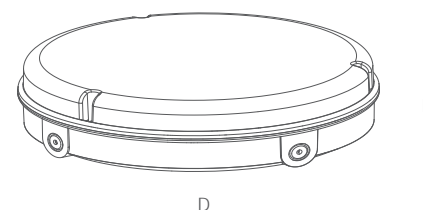

Pro is a 4 knock-out bulkhead. It is a IP65 and UV-Anti with full plastic case.
The multiple function options make the Pro same as the other bulkhead which is widely used on the indoor and outdoor applications.
High technology LED makes the more higher lumem output.

► Features

- > Up to 150lm/W@2400 LM
- > IP65 waterproof
- > UV-Anti
- > Various of function options
- > Warranty: 5 years

► Data Sheet

| Order Code | Rated Power | Lumen | LM/W | Function | Flicker Free | Dimension (mm) | GW/CTN | QTY/CTN |
|----------------------|-------------|----------|---------|----------|--------------|----------------|--------|---------|
| BH28-12DN1-PNFXE-100 | 12W | typ.1800 | Typ.150 | F1-F6 | Y | D280 X H85 | 12.0kg | 10pcs |
| BH28-16DN1-PNFXE-100 | 16W | typ.2400 | Typ.150 | F1-F6 | Y | D280 X H85 | 12.0kg | 10pcs |

► CCT

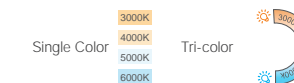

► Function

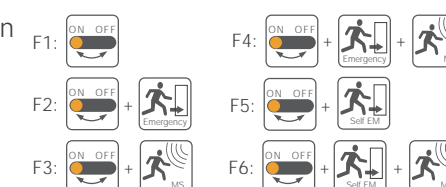

► Electrical Parameters



► Photometric Parameters



► IP Rating



► Finish





Lunar Bulkheads



Lunar D350 | Die-cast

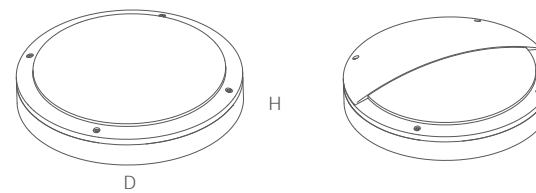

Lunar is die-cast bulkhead with full and half moon cover. It is widely used at outdoor applications due to the IP65 / UV-anti / Aluminum case as heating sink. Easy quick installation - wall or ceiling mounted. High technology LED provide a more higher lumen output.

- Features
 - > UP to 150lm/W@4500LM
 - > Die-cast Aluminum case as heating sink
 - > IP65 waterproof & UV-Anti
 - > 5 years warranty

► Data Sheet

| Order Code | Rated Power | Lumen | LM/W | Function | Flicker Free | Dimension (mm) | GW/CTN | QTY/CTN |
|----------------------|-------------|----------|---------|----------|--------------|----------------|--------|---------|
| BH35-20DN1-LDFXE-001 | 20W | typ.3000 | typ.150 | F1-F6 | Y | D350 X H107 | 12.0kg | 4pcs |
| BH35-30DN1-LDFXE-001 | 30W | typ.4500 | typ.150 | F1-F6 | Y | D350 X H107 | 12.0kg | 4pcs |

- CCT
 - Single Color: 3000K, 4000K, 5000K, 6000K
 - Tri-color: 3000K, 4000K, 5000K, 6000K
- Function
 - F1: ON/OFF
 - F2: ON/OFF + Emergency
 - F3: ON/OFF + MS
 - F4: ON/OFF + Emergency + MS
 - F5: ON/OFF + Self EM
 - F6: ON/OFF + Self EM + MS
- Electrical Parameters
 - AC 200-240V
 - PF ≥0.95
 - THD <15%
 - Flicker Free
- Photometric Parameters
 - 120 LM/W
 - 150 LM/W
 - CRI>80 SDCM <5
 - LM79 TM-21
 - ERP2.0
- IP Rating
 - IP65
- Finish
 - White
 - Gray
 - Black



Lunar

D275 | Die-cast

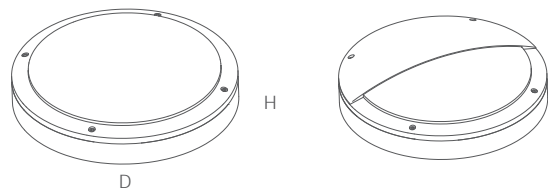

Lunar is die-cast bulkhead with full and half moon cover. It is widely used at outdoor applications due to the IP65 / UV-anti / Aluminum case as heating sink. Easy quick installation - wall or ceiling mounted. High technology LED provide a more higher lumen output.

► Features

- > UP to 130lm/W@2100LM
- > Die-cast Aluminum case as heating sink
- > IP65 waterproof & UV-Anti
- > 5 years warranty

► Data Sheet

| Order Code | Rated Power | Lumen | LM/W | Function | Flicker Free | Dimension (mm) | GW/CTN | QTY/CTN |
|----------------------|-------------|----------|---------|----------|--------------|----------------|--------|---------|
| BH27-12KN1-LDFXE-001 | 12W | typ.1500 | typ.130 | F1-F6 | Y | D275 X H80 | 11.0kg | 5pcs |
| BH27-16KN1-LDFXE-001 | 16W | typ.2100 | typ.130 | F1-F6 | Y | D275 X H80 | 11.0kg | 5pcs |



Lunar Mini

D220 | Die-cast

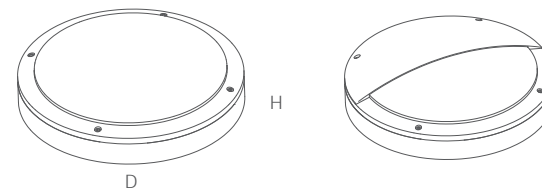

Lunar is die-cast bulkhead with full and half moon cover. It is widely used at outdoor applications due to the IP65 / UV-anti / Aluminum case as heating sink. Easy quick installation - wall or ceiling mounted. High technology LED provide a more higher lumen output.

► Features

- > UP to 100lm/W@1000LM
- > Die-cast Aluminum case as heating sink
- > IP65 waterproof & UV-Anti
- > 5 years warranty

► Data Sheet

| Order Code | Rated Power | Lumen | LM/W | Function | Flicker Free | Dimension (mm) | GW/CTN | QTY/CTN |
|----------------------|-------------|----------|---------|----------|--------------|----------------|--------|---------|
| BH22-10KN1-LDFXE-001 | 10W | typ.1000 | typ.100 | F1-F6 | Y | D222 X H66 | 11.0kg | 10pcs |

► CCT: Single Color (3000K, 4000K, 5000K, 6000K), Tri-color (2700K, 3000K, 3500K, 4000K, 4500K, 5000K, 5500K, 6000K)

► Function: F1: ON/OFF; F2: ON/OFF + Emergency; F3: ON/OFF + MS; F4: ON/OFF + Emergency + MS; F5: ON/OFF + Self EM; F6: ON/OFF + Self EM + MS

► Electrical Parameters: AC 200-240V, PF ≥0.95, THD <15%, Flicker Free

► Photometric Parameters: 100 LM/W, 130 LM/W, CRI>80 SDCM <5, LM79 TM-21, ERP2.0

► IP Rating: IP65

► Finish: White, Gray, Black

► CCT: Single Color (3000K, 4000K, 5000K, 6000K), Tri-color (2700K, 3000K, 3500K, 4000K, 4500K, 5000K, 5500K, 6000K)

► Function: F1: ON/OFF; F2: ON/OFF + Emergency; F3: ON/OFF + MS; F4: ON/OFF + Emergency + MS; F5: ON/OFF + Self EM; F6: ON/OFF + Self EM + MS

► Electrical Parameters: AC 200-240V, PF ≥0.95, THD <15%, Flicker Free

► Photometric Parameters: 100 LM/W, CRI>80 SDCM <5, LM79 TM-21, ERP2.0

► IP Rating: IP65

► Finish: White, Gray, Black



Eclips Bulkheads



Aluminum bottom case

Aluminum case with the clips inside to support the gear tray installation

Polycarbonate Cover

Made from virgin polycarbonate achieving high transmittance of 80% and vandal resistance rating of IK08.



Multifunctional Gear Tray

- Standard ON/OFF
- Standard+ 3h Emergency
- Standard+ Microwave
- Standard+ 3h Emergency + Microwave



Eclips

D435

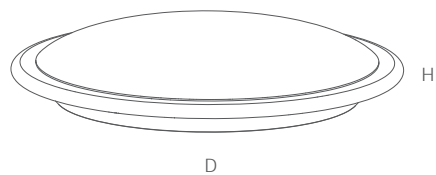

Eclips series is an IP20 bulkheads for indoor use. It use the aluminum case as heat sink and easy installation. 130lm/W output make the eclips bulkhead widely use on various of indoor applications.

Features

- > Up to 130lm/W@3900LM
- > Aluminum housing + PC cover
- > Various of function options
- > Warranty: 5 years

CCT

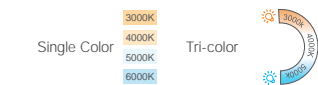

Function

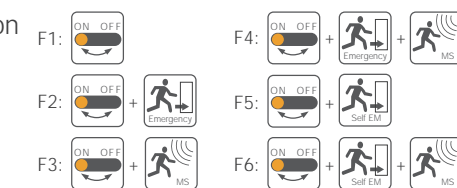

Electrical Parameters



Photometric Parameters



IP Rating



Finish



Data Sheet

| Order Code | Rated Power | Lumen | LM/W | Function | Flicker Free | Dimension (mm) | GW/CTN | QTY/CTN |
|----------------------|-------------|----------|---------|----------|--------------|----------------|--------|---------|
| BH43-20KN1-ESFXE-001 | 20W | typ.2600 | typ.130 | F1-F6 | Y | D435 X H100 | 10.5kg | 5pcs |
| BH43-30KN1-ESFXE-001 | 30W | typ.3900 | typ.130 | F1-F6 | Y | D435 X H100 | 10.5kg | 5pcs |



Eclips

D355

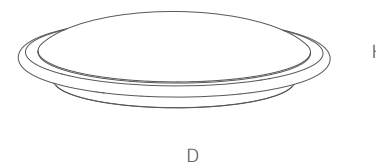

Eclips series is an IP20 bulkheads for indoor use. It use the aluminum case as heat sink and easy installation. 130lm/W output make the eclips bulkhead widely use on various of indoor applications.

Features

- > Up to 130lm/W@3900LM
- > Aluminum housing + PC cover
- > Various of function options
- > Warranty: 5 years

CCT

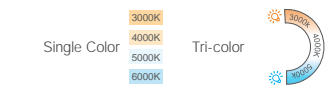

Function

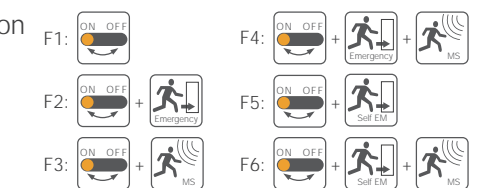

Electrical Parameters



Photometric Parameters



IP Rating



Finish



Data Sheet

| Order Code | Rated Power | Lumen | LM/W | Function | Flicker Free | Dimension (mm) | GW/CTN | QTY/CTN |
|----------------------|-------------|----------|---------|----------|--------------|----------------|--------|---------|
| BH35-20KN1-ESFXE-001 | 20W | typ.2600 | typ.130 | F1-F6 | Y | D355 X H100 | 12.0kg | 10pcs |
| BH35-30KN1-ESFXE-001 | 30W | typ.3900 | typ.130 | F1-F6 | Y | D355 X H100 | 12.0kg | 5pcs |



Inceptor Bulkheads



PCB + LED + Metal plate assembly

PS diffuser as the light guide

Prismatic diffuser for UGR<19

Aluminum outer ring

The aluminum outer ring provide the white and black color

Installation junction with functional module

Standard ON/OFF
Standard+ 3h Emergency
Standard+ Microwave
Standard+ 3h Emergency + Microwave



Inceptor

D450

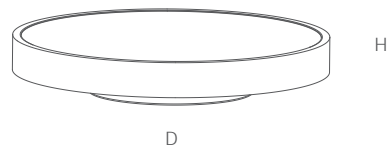

Inceptor series is a low glare/UGR<19 and IP20 ceiling light, the classic round shape is simple and elegant, the low-glare lighting design makes it suitable for a variety of indoor applications.

120lm/W and UGR<19 features make the more and more client interest in the inceptor ceiling light.

► Features

- > Up to 120lm/W@3600LM
- > Aluminum round shape + Prismatic diffuser UGR<19
- > Junction box for easy installation
- > Various of function options
- > Warranty: 5 years

► CCT

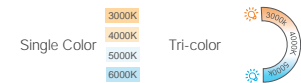

► Function



► Electrical Parameters



► Photometric Parameters



► IP Rating



► Finish



► Data Sheet

| Order Code | Rated Power | Lumen | LM/W | Function | Flicker Free | Dimension (mm) | GW/CTN | QTY/CTN |
|----------------------|-------------|----------|---------|----------|--------------|----------------|--------|---------|
| BH45-20KN1-CPFXE-001 | 20W | typ.2400 | typ.120 | F1-F6 | Y | D450 X H80 | 17.0kg | 5pcs |
| BH45-30KN1-CPFXE-001 | 30W | typ.3600 | typ.120 | F1-F6 | Y | D450 X H80 | 17.0kg | 5pcs |



Inceptor

D350

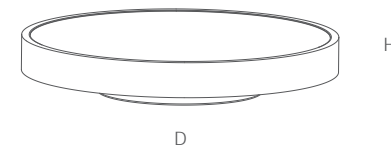

Inceptor series is a low glare/UGR<19 and IP20 ceiling light, the classic round shape is simple and elegant, the low-glare lighting design makes it suitable for a variety of indoor applications.

120lm/W and UGR<19 features make the more and more client interest in the inceptor ceiling light.

► Features

- > Up to 120lm/W@2400LM
- > Aluminum round shape + Prismatic diffuser UGR<19
- > Junction box for easy installation
- > Various of function options
- > Warranty: 5 years

► CCT

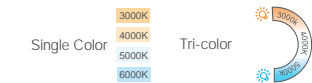

► Function



► Electrical Parameters



► Photometric Parameters



► IP Rating



► Finish



► Data Sheet

| Order Code | Rated Power | Lumen | LM/W | Function | Flicker Free | Dimension (mm) | GW/CTN | QTY/CTN |
|----------------------|-------------|----------|---------|----------|--------------|----------------|--------|---------|
| BH35-20KN1-CPFXE-001 | 20W | typ.2400 | typ.120 | F1-F6 | Y | D350 X H80 | 14.0kg | 5pcs |
| BH35-30KN1-CPFXE-001 | 30W | typ.3600 | typ.120 | F1-F6 | Y | D350 X H80 | 14.0kg | 5pcs |



Astro Deltao Bulkheads

PC cover + gear tray assembly with functional module

- Standard ON/OFF
- Standard+ 3h Emergency
- Standard+ Microwave
- Standard+ 3h Emergency + Microwave

installation bottom plastic case

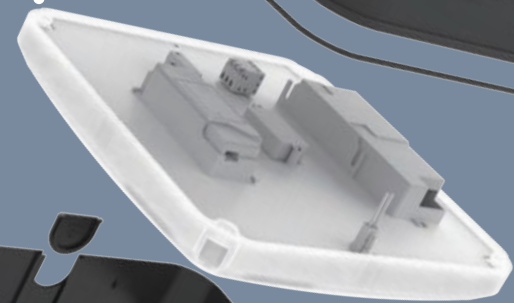
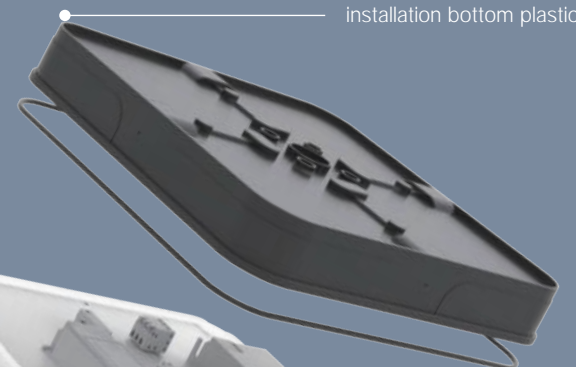

Waterproof gasket

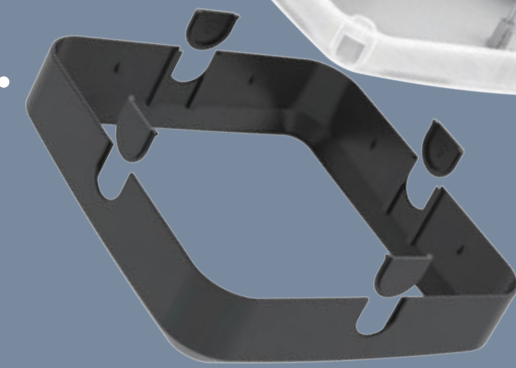

Plastic outer ring

The plastic outer ring provide the white and black color with 4 knock-out clips



Astro D260

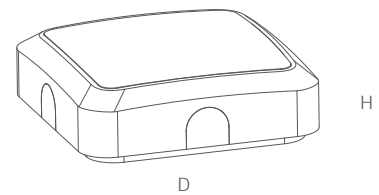

Astro series bulkheads be designed a function gear tray which be assembled together with PC cover as a assembly unit.

The 4 knock-out clips on the middle rings makes the Astro very easy on the installation.

► Features

- > Up to 130lm/W@2600LM
- > IP65 waterproof
- > UV-Anti
- > Various of function options
- > Warranty: 5 years

► CCT

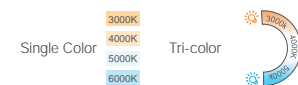

► Function



► Electrical Parameters



► Photometric Parameters



► IP Rating



► Finish



► Data Sheet

| Order Code | Rated Power | Lumen | LM/W | Function | Flicker Free | Dimension (mm) | GW/CTN | QTY/CTN |
|----------------------|-------------|----------|---------|----------|--------------|----------------|--------|---------|
| BH26-16KN1-ALFXE-001 | 16W | typ.2050 | typ.130 | F1-F6 | Y | D263 X H74 | 11.0kg | 5pcs |
| BH26-20KN1-ALFXE-001 | 20W | typ.2600 | typ.130 | F1-F6 | Y | D263 X H74 | 11.0kg | 5pcs |



Astro Mini D200

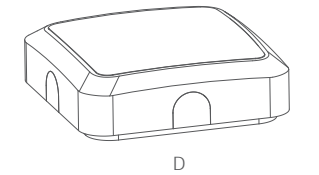

Astro series bulkheads be designed a function gear tray which be assembled together with PC cover as a assembly unit.

The 4 knock-out clips on the middle rings makes the Astro very easy on the installation.

► Features

- > Up to 100lm/W@1600LM
- > IP65 waterproof
- > UV-Anti
- > Various of function options
- > Warranty: 5 years

► CCT

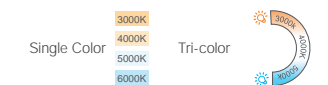

► Function

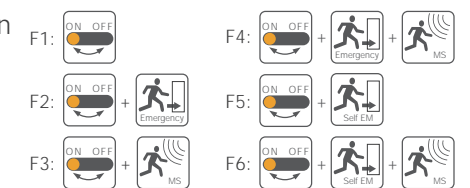

► Electrical Parameters



► Photometric Parameters



► IP Rating



► Finish



► Data Sheet

| Order Code | Rated Power | Lumen | LM/W | Function | Flicker Free | Dimension (mm) | GW/CTN | QTY/CTN |
|----------------------|-------------|----------|---------|----------|--------------|----------------|--------|---------|
| BH20-07KN1-AMFXE-001 | 7W | typ.700 | typ.100 | F1-F6 | Y | D200 X H65 | 9.7kg | 5pcs |
| BH20-14KN1-AMFXE-001 | 14W | typ.1400 | typ.100 | F1-F6 | Y | D200 X H65 | 9.7kg | 5pcs |



Delta

D290

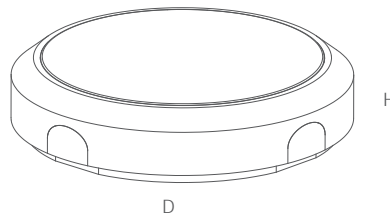

Delta series bulkheads be designed a function gear tray which be assembled together with PC cover as a assembly unit.

The 4 knock-out clips on the middle rings makes the Delta very easy on the installation.

► Features

- > Up to 130lm/W@2600LM
- > IP65 waterproof
- > UV-Anti
- > Various of function options
- > Warranty: 5 years

► CCT



► Function

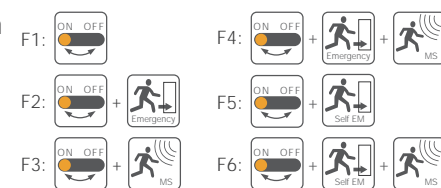

► Electrical Parameters



► Photometric Parameters



► IP Rating



► Finish

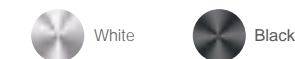

► Data Sheet

| Order Code | Rated Power | Lumen | LM/W | Function | Flicker Free | Dimension (mm) | GW/CTN | QTY/CTN |
|----------------------|-------------|----------|---------|----------|--------------|----------------|--------|---------|
| BH29-16KN1-DLFXE-100 | 16W | typ.2100 | typ.130 | F1-F6 | Y | D290 X H74 | 11.0kg | 5pcs |
| BH29-20KN1-DLFXE-100 | 20W | typ.2600 | typ.130 | F1-F6 | Y | D290 X H74 | 11.0kg | 5pcs |



Delta Mini

D200

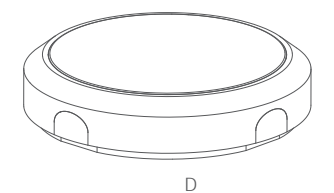

Delta series bulkheads be designed a function gear tray which be assembled together with PC cover as a assembly unit.

The 4 knock-out clips on the middle rings makes the Delta very easy on the installation.

► Features

- > Up to 100lm/W@1600LM
- > IP65 waterproof
- > UV-Anti
- > Various of function options
- > Warranty: 5 years

► CCT

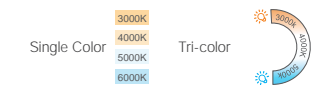

► Function

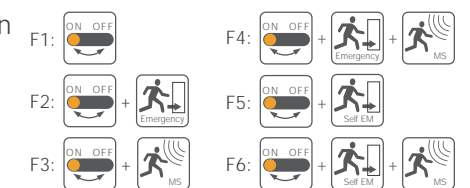

► Electrical Parameters



► Photometric Parameters



► IP Rating



► Finish



► Data Sheet

| Order Code | Rated Power | Lumen | LM/W | Function | Flicker Free | Dimension (mm) | GW/CTN | QTY/CTN |
|----------------------|-------------|----------|---------|----------|--------------|----------------|--------|---------|
| BH20-07KN1-LDFXE-100 | 7W | typ.700 | typ.100 | F1-F6 | Y | D200 X H65 | 9.7kg | 5pcs |
| BH20-14KN1-LDFXE-100 | 14W | typ.1400 | typ.100 | F1-F6 | Y | D200 X H65 | 9.7kg | 5pcs |



Nova

L230

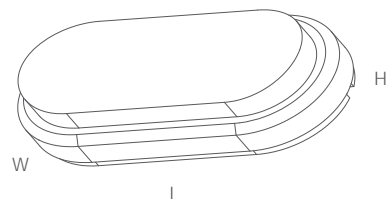

Nova series bulkhead is a compact IP65 outdoor luminaire, the simple line design makes it suitable for different decoration styles, the output of 1600LM can provide enough guiding lighting, mainly used in halls, exterior walls, corridors and etc.

Features

- > IP65 Waterproof
- > UV resistant plastic case
- > Mini dimension

- ▶ CCT: Single Color (3000K, 4000K, 5000K, 6000K), Tri-color (2700K, 3000K, 3500K, 4000K)
- ▶ Function: F1:
- ▶ Electrical Parameters: AC 200-240V, PF ≥0.95, THD <15%, Flicker Free
- ▶ Photometric Parameters: 100 LM/W, CRI>80 SDCM <5, LM79 TM-21, ERP2.0
- ▶ IP Rating: IP65
- ▶ Finish: White Gray Black

Data Sheet

| Order Code | Rated Power | Lumen | LM/W | Function | Flicker Free | Dimension (mm) | GW/CTN | QTY/CTN |
|---------------------|-------------|----------|---------|----------|--------------|-------------------|--------|---------|
| BH23-12GN1-NVN1E-00 | 12W | typ.1200 | typ.100 | F1 | Y | L230 X W105 X H55 | 18.0kg | 20pcs |
| BH23-16GN1-NVN1E-00 | 16W | typ.1600 | typ.100 | F1 | Y | L230 X W105 X H55 | 18.0kg | 20pcs |



Nova

L200

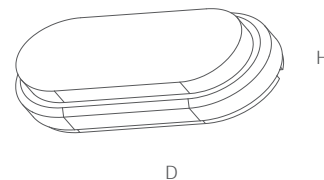

Nova series bulkhead is a compact IP65 outdoor luminaire, the simple line design makes it suitable for different decoration styles, the output of 1600LM can provide enough guiding lighting, mainly used in halls, exterior walls, corridors and etc.

Features

- > IP65 Waterproof
- > UV resistant plastic case
- > Mini dimension

- ▶ CCT: Single Color (3000K, 4000K, 5000K, 6000K), Tri-color (2700K, 3000K, 3500K, 4000K)
- ▶ Function: F1:
- ▶ Electrical Parameters: AC 200-240V, PF ≥0.95, THD <15%, Flicker Free
- ▶ Photometric Parameters: 100 LM/W, CRI>80 SDCM <5, LM79 TM-21, ERP2.0
- ▶ IP Rating: IP65
- ▶ Finish: White Gray Black

Data Sheet

| Order Code | Rated Power | Lumen | LM/W | Function | Flicker Free | Dimension (mm) | GW/CTN | QTY/CTN |
|---------------------|-------------|----------|---------|----------|--------------|-------------------|--------|---------|
| BH20-12GN1-NVN1E-00 | 12W | typ.1200 | typ.100 | F1 | Y | L200 X W105 X H55 | 17.0kg | 20pcs |
| BH20-16GN1-NVN1E-00 | 16W | typ.1600 | typ.100 | F1 | Y | L200 X W105 X H55 | 17.0kg | 20pcs |



Backlit Panel

/Series/

- > Backlit Panel Light is one of the most popular luminaire for commercial lighting in the market, with helpful solution and effective cost.
- > The backlit panel light family supply different solution for project and distribution, such as high lumen 160lm/w, low glare UGR<19@150lm/w, CC Tadjustable, IP44 waterproof, TP(a)/TP(b) fire rated panel light with recessed / surface mounted / suspension installation.



P01 HB | 160lm/w

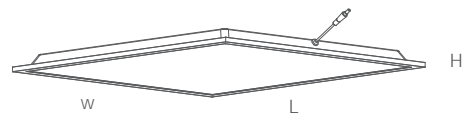

P01 Back-lit Panel light is a direct lighting with external driver, adopts SMD led with optical lens to provide a uniform light effect, no LGP design makes the panel light more cost effective, high lumen efficiency available with 105lm/W, 120lm/W, 140lm/W, 160lm/W. Recessed, suspended, and surface mounted installation available.

► Features

- > Ultra flat casing: 32mm
- > Up to 160lm/W@8000LM
- > White frame color: RAL9016
- > Flicker free & 5 years warranty

► Data Sheet

| Order Code | Rated Power | Lumen | LM/W | Flicker Free | Dimension (mm) | GW/CTN | QTY/CTN |
|----------------------|-------------|----------|---------|--------------|--------------------|--------|---------|
| PN22-30TN1-BNN1E-001 | 30W | typ.4800 | typ.160 | Y | L595 X W595 X H32 | 24.0kg | 10pcs |
| PN41-30AN1-BNN1E-001 | 30W | typ.4200 | typ.140 | Y | L1195 X W295 X H32 | 12.0kg | 5pcs |
| PN42-50TN1-BNN1E-001 | 50W | typ.8000 | typ.160 | Y | L1195 X W595 X H32 | 24.0kg | 5pcs |
| PN62-30TN1-BNN1E-001 | 30W | typ.4800 | typ.160 | Y | L620 X W620 X H32 | 24.5kg | 10pcs |



- CCT: Single Color (3000K, 4000K, 5000K, 6000K), Tri-color (3000K, 4000K, 5000K)
- Function: ON/OFF, 1-10V Dimming, DALI, Emergency
- Electrical Parameters: AC 200-240V, PF ≥0.95, THD <15%, Flicker Free
- Photometric Parameters: 105/120 LM/W, 140/160 LM/W, CRI>80 SDCM <5, LM79 TM-21, ERP2.0
- Installation: Recessed, Surface Mounted, Suspension
- IP Rating: IP20, IP44



P03 TP(b) | 160lm/w

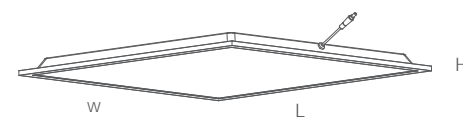

P03 Back-lit Panel light is a direct lighting with TP(b) fire rated, adopts SMD led with optical lens to provide a uniform light effect, no LGP design makes the panel light more cost effective, high lumen efficiency available with 105lm/W, 120lm/W, 140lm/W, 160lm/W. Recessed, suspended, and surface mounted installation available.

► Features

- > Ultra flat casing: 32mm
- > Up to 160lm/W@8000LM
- > White frame color: RAL9016
- > Flicker free & 5 years warranty

► Data Sheet

| Order Code | Rated Power | Lumen | LM/W | Flicker Free | Dimension (mm) | GW/CTN | QTY/CTN |
|----------------------|-------------|----------|---------|--------------|--------------------|--------|---------|
| PN22-30TN1-BDN1E-001 | 30W | typ.4800 | typ.160 | Y | L595 X W595 X H32 | 24.0kg | 10pcs |
| PN41-30AN1-BDN1E-001 | 30W | typ.4200 | typ.140 | Y | L1195 X W295 X H32 | 12.0kg | 5pcs |
| PN42-50TN1-BDN1E-001 | 50W | typ.8000 | typ.160 | Y | L1195 X W595 X H32 | 24.0kg | 5pcs |
| PN62-30TN1-BDN1E-001 | 30W | typ.4800 | typ.160 | Y | L620 X W620 X H32 | 24.5kg | 10pcs |



- CCT: Single Color (3000K, 4000K, 5000K, 6000K), Tri-color (3000K, 4000K, 5000K)
- Function: ON/OFF, 1-10V Dimming, DALI, Emergency, TP(b)
- Electrical Parameters: AC 200-240V, PF ≥0.95, THD <15%, Flicker Free
- Photometric Parameters: 105/120 LM/W, 140/160 LM/W, CRI>80 SDCM <5, LM79 TM-21, ERP2.0
- Installation: Recessed, Surface Mounted, Suspension
- IP Rating: IP20, IP44



P05

HB | UGR<19 | 150lm/w

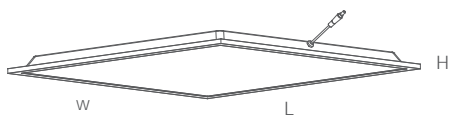

P05 Back-lit Panel light is a direct lighting with low glare UGR<19, adopts SMD led with optical lens to provide a uniform light effect, no LGP design makes the panel light more cost effective, high lumen efficiency available with 105lm/W, 120lm/W, 140lm/W, 150lm/W. Recessed, suspended, and surface mounted installation available.

► Features

- > Ultra flat casing: 32mm
- > Up to 150lm/W@7500LM, UGR<19
- > White frame color: RAL9016
- > Flicker free & 5 years warranty

► Data Sheet

| Order Code | Rated Power | Lumen | LM/W | Flicker Free | Dimension (mm) | GW/CTN | QTY/CTN |
|----------------------|-------------|----------|---------|--------------|--------------------|--------|---------|
| PN22-30DN1-BBN1E-001 | 30W | typ.4500 | typ.150 | Y | L595 X W595 X H32 | 24.0kg | 10pcs |
| PN41-30AN1-BBN1E-001 | 30W | typ.4200 | typ.140 | Y | L1195 X W295 X H32 | 12.0kg | 5pcs |
| PN42-50DN1-BBN1E-001 | 50W | typ.7500 | typ.150 | Y | L1195 X W595 X H32 | 24.0kg | 5pcs |
| PN62-30DN1-BBN1E-001 | 30W | typ.4500 | typ.150 | Y | L620 X W620 X H32 | 24.5kg | 10pcs |

- CCT: Single Color (3000K, 4000K, 5000K, 6000K), Tri-color (3000K, 4000K, 5000K)
- Function: ON/OFF, 1-10V Dimming, DALI, Emergency
- Electrical Parameters: AC 200-240V, PF ≥0.95, THD <15%, Flicker Free
- Photometric Parameters: 105/120 LM/W, 140/150 LM/W, CRI>80 SDCM <5, LM79 TM-21, ERP2.0, UGR <19
- Installation: Recessed, Surface Mounted, Suspension
- IP Rating: IP20, IP44

P07

TP(b) | UGR<19 | 150lm/w

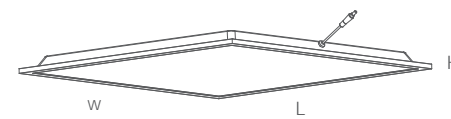

P07 Back-lit Panel light is a direct lighting with low glare UGR<19, TP(b) fire rated, adopts SMD led with optical lens to provide a uniform light effect, no LGP design makes the panel light more cost effective, high lumen efficiency available with 105lm/W, 120lm/W, 140lm/W, 150lm/W. Recessed, suspended, and surface mounted installation available.

► Features

- > Ultra flat casing: 32mm
- > Up to 150lm/W@7500LM, UGR<19, TP(b)
- > White frame color: RAL9016
- > Flicker free & 5 years warranty

► Data Sheet

| Order Code | Rated Power | Lumen | LM/W | Flicker Free | Dimension (mm) | GW/CTN | QTY/CTN |
|----------------------|-------------|----------|---------|--------------|--------------------|--------|---------|
| PN22-30DN1-BFN1E-001 | 30W | typ.4500 | typ.150 | Y | L595 X W595 X H32 | 24.0kg | 10pcs |
| PN41-30AN1-BFN1E-001 | 30W | typ.4200 | typ.140 | Y | L1195 X W295 X H32 | 12.0kg | 5pcs |
| PN42-50DN1-BFN1E-001 | 50W | typ.7500 | typ.150 | Y | L1195 X W595 X H32 | 24.0kg | 5pcs |
| PN62-30DN1-BFN1E-001 | 30W | typ.4500 | typ.150 | Y | L620 X W620 X H32 | 24.5kg | 10pcs |

- CCT: Single Color (3000K, 4000K, 5000K, 6000K), Tri-color (3000K, 4000K, 5000K)
- Function: ON/OFF, 1-10V Dimming, DALI, Emergency, TP(b)
- Electrical Parameters: AC 200-240V, PF ≥0.95, THD <15%, Flicker Free
- Photometric Parameters: 105/120 LM/W, 140/150 LM/W, CRI>80 SDCM <5, LM79 TM-21, ERP2.0, UGR <19
- Installation: Recessed, Surface Mounted, Suspension
- IP Rating: IP20, IP44



Prismatic

P09

TP(a) | UGR<19 | 150lm/w

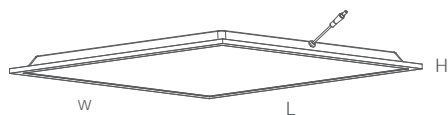

P09 Back-lit Panel light is a direct lighting with low glare UGR<19, TP(a) fire rated, adopts SMD led with optical lens to provide a uniform light effect, no LGP design makes the panel light more cost effective, high lumen efficiency available with 105lm/W, 120lm/W, 140lm/W, 150lm/W. Recessed, suspended, and surface mounted installation available.

► Features

- > Ultra flat casing: 32mm
- > Up to 150lm/W@7500LM, UGR<19, TP(a)
- > White frame color: RAL9016
- > Flicker free & 5 years warranty

- CCT
 - Single Color: 3000K, 4000K, 5000K, 6000K
 - Tri-color: 3000K, 4000K, 5000K
- Function
 - ON/OFF
 - 1-10V Dimming
 - DALI
 - Emergency
 - TP(a)
- Electrical Parameters
 - AC 200-240V
 - PF ≥0.95
 - THD <15%
 - Flicker Free
- Photometric Parameters
 - 105/120 LM/W
 - 140/150 LM/W
 - CRI>80 SDCM <5
 - LM79 TM-21
 - ERP2.0
 - UGR <19
- Installation
 - Recessed
 - Surface Mounted
 - Suspension
- IP Rating
 - IP20
 - IP44

► Data Sheet

| Order Code | Rated Power | Lumen | LM/W | Flicker Free | Dimension (mm) | GW/CTN | QTY/CTN |
|----------------------|-------------|----------|---------|--------------|--------------------|--------|---------|
| PN22-30DN1-BKN1E-001 | 30W | typ.4500 | typ.150 | Y | L595 X W595 X H32 | 24.0kg | 10pcs |
| PN41-30AN1-BKN1E-001 | 30W | typ.4200 | typ.140 | Y | L1195 X W295 X H32 | 12.0kg | 5pcs |
| PN42-50DN1-BKN1E-001 | 50W | typ.7500 | typ.150 | Y | L1195 X W595 X H32 | 24.0kg | 5pcs |
| PN62-30DN1-BKN1E-001 | 30W | typ.4500 | typ.150 | Y | L620 X W620 X H32 | 24.5kg | 10pcs |



P11

TP(a) | 160lm/w

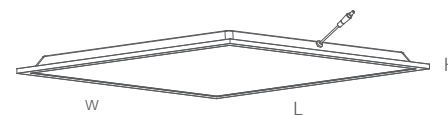

P11 Back-lit Panel light is a direct lighting with, TP(a) fire rated, adopts SMD led with optical lens to provide a uniform light effect, no LGP design makes the panel light more cost effective, high lumen efficiency available with 105lm/W, 120lm/W, 150lm/W, 160lm/W. Recessed, suspended, and surface mounted installation available.

► Features

- > Ultra flat casing: 32mm
- > Up to 160lm/W@8000LM, TP(a)
- > White frame color: RAL9016
- > Flicker free & 5 years warranty

- CCT
 - Single Color: 3000K, 4000K, 5000K, 6000K
 - Tri-color: 3000K, 4000K, 5000K
- Function
 - ON/OFF
 - 1-10V Dimming
 - DALI
 - Emergency
 - TP(a)
- Electrical Parameters
 - AC 200-240V
 - PF ≥0.95
 - THD <15%
 - Flicker Free
- Photometric Parameters
 - 105/120 LM/W
 - 150/160 LM/W
 - CRI>80 SDCM <5
 - LM79 TM-21
 - ERP2.0
- Installation
 - Recessed
 - Surface Mounted
 - Suspension
- IP Rating
 - IP20
 - IP44

► Data Sheet

| Order Code | Rated Power | Lumen | LM/W | Flicker Free | Dimension (mm) | GW/CTN | QTY/CTN |
|----------------------|-------------|----------|---------|--------------|--------------------|--------|---------|
| PN22-30TN1-BHN1E-001 | 30W | typ.4800 | typ.160 | Y | L595 X W595 X H32 | 24.0kg | 10pcs |
| PN41-30DN1-BHN1E-001 | 30W | typ.4500 | typ.150 | Y | L1195 X W295 X H32 | 12.0kg | 5pcs |
| PN42-50TN1-BHN1E-001 | 50W | typ.8000 | typ.160 | Y | L1195 X W595 X H32 | 24.0kg | 5pcs |
| PN62-30TN1-BHN1E-001 | 30W | typ.4800 | typ.160 | Y | L620 X W620 X H32 | 24.5kg | 10pcs |



Edgelit Panel

/Series/

- > Edgelit Panel Light is one of the most popular luminaire for commercial lighting in the market, with PMMA LGP as the light guide.
- > The panel light family supply different solution for project and distribution, such as low glare $UGR < 19 @ 140lm/w$, CCT adjustable, TP(a) / TP(b) fire rated panel light with recessed / surface mounted / suspension installation.



P02

HB | UGR>19 | 140lm/w

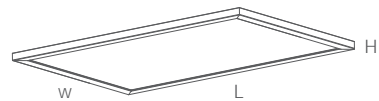

P02 Edge-lit panel is an effective cost panel. PMMA LGP produce uniform light high lumen output up to 140lm/W. It can fit seamlessly into any work place. It is available in recessed, suspended and surface mounted installation method. It makes the panels widely use on various of applications.

► Features

- > Suitably efficient - up to 140lm/W
- > High Luminous flux - up to 7000lm
- > PMMA LGP as light guide
- > Extra thin aluminum frame
- > 5 years warranty

► Data Sheet

| Order Code | Rated Power | Lumen | LM/W | Flicker Free | Dimension (mm) | GW/CTN | QTY/CTN |
|----------------------|-------------|----------|---------|--------------|--------------------|--------|---------|
| PN22-30AN1-FNN1E-001 | 30W | typ.4200 | typ.140 | Y | L595 X W595 X H10 | 13.0kg | 4pcs |
| PN41-30PN1-FNN1E-001 | 30W | typ.3900 | typ.130 | Y | L1195 X W295 X H10 | 16.5kg | 5pcs |
| PN42-50AN1-FNN1E-001 | 50W | typ.7000 | typ.140 | Y | L1195 X W595 X H10 | 12.0kg | 2pcs |
| PN62-30AN1-FNN1E-001 | 30W | typ.4200 | typ.140 | Y | L620 X W620 X H10 | 16.0kg | 4pcs |

► CCT

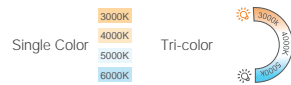

► Function



► Electrical Parameters



► Photometric Parameters



► Installation



► IP Rating

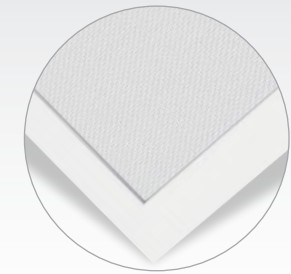

Prismatic

P04

HB | UGR<19 | 140lm/w

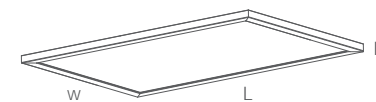

P04 Edge-lit panel is Non fire rated low glare panel up to 140lm/W. The comfortable light and high color consistency for various of applications.

It is available in recessed, suspended and surface mounted installation method. It makes the panels were widely use on various of applications.

► Features

- > Prismatic UGR<19
- > Suitably efficient - up to 140lm/W
- > High Luminous flux - up to 7000lm
- > PMMA LGP as light guide
- > Extra thin aluminum frame
- > 5 years warranty

► Data Sheet

| Order Code | Rated Power | Lumen | LM/W | Flicker Free | Dimension (mm) | GW/CTN | QTY/CTN |
|----------------------|-------------|----------|---------|--------------|--------------------|--------|---------|
| PN22-30AN1-FBN1E-001 | 30W | typ.4200 | typ.140 | Y | L595 X W595 X H10 | 13.0kg | 4pcs |
| PN41-30PN1-FBN1E-001 | 30W | typ.3900 | typ.130 | Y | L1195 X W295 X H10 | 16.5kg | 5pcs |
| PN42-50AN1-FBN1E-001 | 50W | typ.7000 | typ.140 | Y | L1195 X W595 X H10 | 12.0kg | 2pcs |
| PN62-30AN1-FBN1E-001 | 30W | typ.4200 | typ.140 | Y | L620 X W620 X H10 | 16.0kg | 4pcs |

► CCT



► Function



► Electrical Parameters



► Photometric Parameters



► Installation



► IP Rating





P06

TP(b) | UGR>19 | 140lm/w

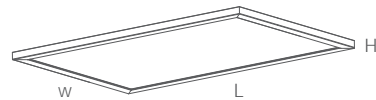

P06 Edge-lit panel is TP(b) and low glare panel PMMA LGP produce uniform light high lumen up to 140lm/W.

The panels are available in recessed, suspended and surface mounted installation, it makes the panels were widely use on various of applications.

► Features

- > TP(b) fire rated
- > Suitably efficient - up to 140lm/W
- > High Luminous flux - up to 7000lm
- > PMMA LGP as light guide
- > Extra thin aluminum frame
- > 5 years warranty

► Data Sheet

| Order Code | Rated Power | Lumen | LM/W | Flicker Free | Dimension (mm) | GW/CTN | QTY/CTN |
|----------------------|-------------|----------|---------|--------------|--------------------|--------|---------|
| PN22-30AN1-FDN1E-001 | 30W | typ.4200 | typ.140 | Y | L595 X W595 X H10 | 13.0kg | 4pcs |
| PN41-30PN1-FDN1E-001 | 30W | typ.3900 | typ.130 | Y | L1195 X W295 X H10 | 16.5kg | 5pcs |
| PN42-50AN1-FDN1E-001 | 50W | typ.7000 | typ.140 | Y | L1195 X W595 X H10 | 12.0kg | 2pcs |
| PN62-30AN1-FDN1E-001 | 30W | typ.4200 | typ.140 | Y | L620 X W620 X H10 | 16.0kg | 4pcs |

- CCT: Single Color (3000K, 4000K, 5000K, 6000K), Tri-color (2700K, 3000K, 3500K, 4000K)
- Function: ON/OFF, 1-10V Dimming, DALI, Emergency, TP(b)
- Electrical Parameters: AC 200-240V, PF ≥0.95, THD <15%, Flicker Free
- Photometric Parameters: 105/120 LM/W, 130/140 LM/W, CRI>80 SDCM <5, LM79 TM-21, ERP2.0
- Installation: Recessed, Surface Mounted, Suspension
- IP Rating: IP20

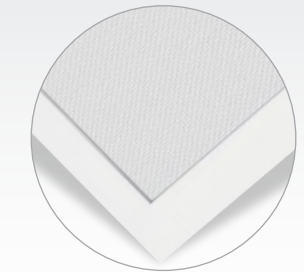

Prismatic

P08

TP(b) | UGR<19 | 140lm/w

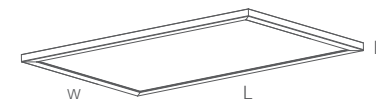

P08 Edge-lit panel is a TP(b) and low glare panel up to 140lm/W. It is perfect for use in commercial buildings and environments.

It is available in recessed, suspended and surface mounted installation method. It makes the panels were widely use on various of applications.

► Features

- > Suitably efficient - up to 140lm/W
- > High Luminous flux - up to 7000lm
- > PMMA LGP as light guide
- > Prismatic UGR<19, TP(b) fire-proof
- > Extra thin aluminum frame
- > 5 years warranty

► Data Sheet

| Order Code | Rated Power | Lumen | LM/W | Flicker Free | Dimension (mm) | GW/CTN | QTY/CTN |
|----------------------|-------------|----------|---------|--------------|--------------------|--------|---------|
| PN22-30AN1-FFN1E-001 | 30W | typ.4200 | typ.140 | Y | L595 X W595 X H10 | 13.0kg | 4pcs |
| PN41-30PN1-FFN1E-001 | 30W | typ.3900 | typ.130 | Y | L1195 X W295 X H10 | 16.5kg | 5pcs |
| PN42-50AN1-FFN1E-001 | 50W | typ.7000 | typ.140 | Y | L1195 X W595 X H10 | 12.0kg | 2pcs |
| PN62-30AN1-FFN1E-001 | 30W | typ.4200 | typ.140 | Y | L620 X W620 X H10 | 16.0kg | 4pcs |

- CCT: Single Color (3000K, 4000K, 5000K, 6000K), Tri-color (2700K, 3000K, 3500K, 4000K)
- Function: ON/OFF, 1-10V Dimming, DALI, Emergency, TP(b)
- Electrical Parameters: AC 200-240V, PF ≥0.95, THD <15%, Flicker Free
- Photometric Parameters: 105/120 LM/W, 130/140 LM/W, CRI>80 SDCM <5, LM79 TM-21, ERP2.0, UGR <19
- Installation: Recessed, Surface Mounted, Suspension
- IP Rating: IP20



P10

TP(a) | UGR>19 | 140lm/w

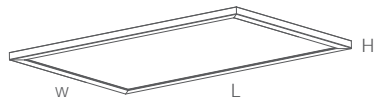

P10 Edge-lit panel is a TP(a) fire rated panel. It is an energy savings solution with up to 140 lm/W lumen output.

The panels are available in recessed, suspended and surface mounted installation, it makes the panels were widely use on various of applications.

► Features

- > TP(a) fire-proof
- > Suitably efficient - up to 140lm/W
- > High Luminous flux - up to 7000lm
- > PMMA LGP as light guide
- > Extra thin aluminum frame
- > 5 years warranty

► Data Sheet

| Order Code | Rated Power | Lumen | LM/W | Flicker Free | Dimension (mm) | GW/CTN | QTY/CTN |
|----------------------|-------------|----------|---------|--------------|--------------------|--------|---------|
| PN22-30AN1-FHN1E-001 | 30W | typ.4200 | typ.140 | Y | L595 X W595 X H10 | 13.0kg | 4pcs |
| PN41-30PN1-FHN1E-001 | 30W | typ.3900 | typ.130 | Y | L1195 X W295 X H10 | 16.5kg | 5pcs |
| PN42-50AN1-FHN1E-001 | 50W | typ.7000 | typ.140 | Y | L1195 X W595 X H10 | 12.0kg | 2pcs |
| PN62-30AN1-FHN1E-001 | 30W | typ.4200 | typ.140 | Y | L620 X W620 X H10 | 16.0kg | 4pcs |

► CCT

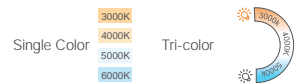

► Function



► Electrical Parameters



► Photometric Parameters



► Installation



► IP Rating



P12

TP(a) | UGR<19 | 140lm/w

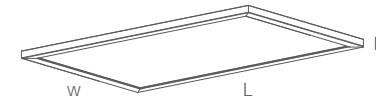

P12 Edge-lit panel is a high end technology with TP(a) fire rated and Low glare. It is up to 140lm/W lumen output.

The various of installation method and professional features make this panel were widely use on office, schools, meeting rooms and commercial applications.

► Features

- > Prismatic UGR<19
- > TP(a) fire-proof
- > Suitably efficient - up to 140lm/W
- > High Luminous flux - up to 7000lm
- > PMMA LGP as light guide
- > Extra thin aluminum frame
- > 5 years warranty

► Data Sheet

| Order Code | Rated Power | Lumen | LM/W | Flicker Free | Dimension (mm) | GW/CTN | QTY/CTN |
|----------------------|-------------|----------|---------|--------------|--------------------|--------|---------|
| PN22-30AN1-FKN1E-001 | 30W | typ.4200 | typ.140 | Y | L595 X W595 X H10 | 13.0kg | 4pcs |
| PN41-30PN1-FKN1E-001 | 30W | typ.3900 | typ.130 | Y | L1195 X W295 X H10 | 16.5kg | 5pcs |
| PN42-50AN1-FKN1E-001 | 50W | typ.7000 | typ.140 | Y | L1195 X W595 X H10 | 12.0kg | 2pcs |
| PN62-30AN1-FKN1E-001 | 30W | typ.4200 | typ.140 | Y | L620 X W620 X H10 | 16.0kg | 4pcs |

► CCT

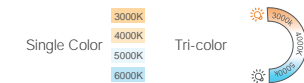

► Function



► Electrical Parameters



► Photometric Parameters



► Installation



► IP Rating



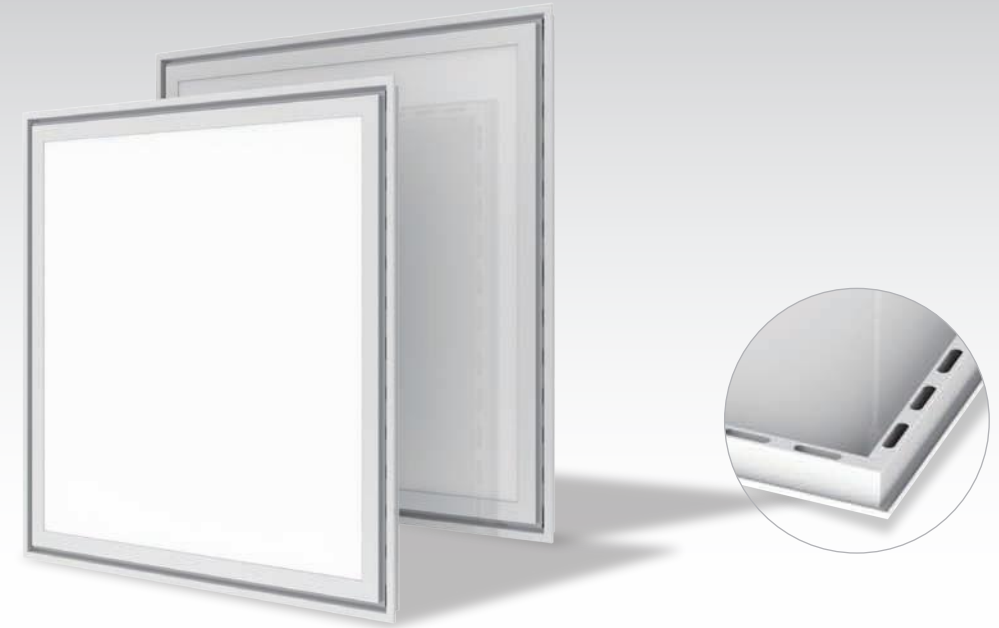

Air Handling Panel

TP(a) | UGR<19 | 140lm/w

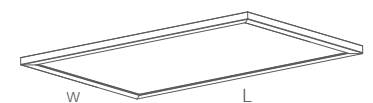

Air Handling Panel Light is not only looks clean and pleasing but also result in visual comfort and good feeling for employees in the offices. Heat transfer, which's important to lighting lifespan, remains efficient due to excellent air-handling and air return over entire space. In a office ventilated with good air quality and provided with excellent thermal comfort, the employees will feel more satisfied and happier, playing a crucial role in productivity and positivity.

► Features

- > Up to 140lm/W
- > Special design for air handling
- > Prismatic UGR<19
- > PMMA LGP
- > 5 years warranty

► Data Sheet

| Order Code | Rated Power | Lumen | LM/W | Flicker Free | Dimension (mm) | GW/CTN | QTY/CTN |
|----------------------|-------------|----------|---------|--------------|--------------------|--------|---------|
| PN21-20KN1-AKN1E-001 | 20W | typ.2400 | typ.120 | Y | L595 X W295 X H25 | 24.0kg | 10pcs |
| PN22-32AN1-AKN1E-001 | 32W | typ.4480 | typ.140 | Y | L595 X W595 X H25 | 21.0kg | 5pcs |
| PN41-32AN1-AKN1E-001 | 32W | typ.4480 | typ.140 | Y | L1195 X W295 X H25 | 21.0kg | 5pcs |
| PN42-50AN1-AKN1E-001 | 50W | typ.7000 | typ.140 | Y | L1195 X W595 X H25 | 44.0kg | 5pcs |

- CCT: Single Color (3000K, 4000K, 5000K, 6000K), Tri-color (2700K, 3000K, 3500K, 4000K, 4500K, 5000K, 5500K, 6000K)
- Function: ON/OFF, 1-10V Dimming, DALI, Emergency, TP(a)
- Electrical Parameters: AC 200-240V, PF ≥0.95, THD <15%, Flicker Free
- Photometric Parameters: 105/120 LM/W, 130/140 LM/W, CRI>80 SDCM <5, LM79 TM-21, ERP2.0, UGR <19
- Installation: Recessed, Surface Mounted, Suspension
- IP Rating: IP20
- Finish: White, Black

Air Handling Panel Light

Improving air quality



Down light

/Series/

LED downlight series provide turn-key lighting solutions in domestic and commercial applications. Our downlight is a combination of technique and emotion. We offer our customers a platform to experience the good quality and lighting effects with unique design, 120lm/w and more. Ra>80 and Ra>90, smart function. Toppo downlight family provides different solutions for projects and distributions with different product types.



Bega Down Light Round shape

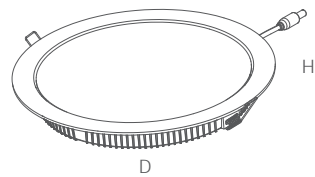

Bega Downlight use the die-cast case as the heating sink which make this down light offer higher lumen output.
Bega down light were widely used in various of different applications.

► Features

- > Die-cast housing as heat sink
- > Recessed installation
- > Full range dimension from 2.5 to 8 inches
- > Package: Standard or color box

► CCT Single Color Tri-color

► Function

► Electrical Parameters

► Photometric Parameters

► Dimension: 2.5 / 4 / 5 / 6 / 8 inches

► Finish White Black

► Data Sheet

| Order Code | Wattage | Lumen | LM/W | Flicker Free | Dimension (mm) | Cut-out(mm) | GW/CTN | QTY/CTN |
|----------------------|---------|----------|---------|--------------|----------------|-------------|--------|---------|
| DL02-05GN1-BRN1E-001 | 5W | typ.450 | typ.90 | Y | ∅100x28 | ∅80 | 5.4kg | 20pcs |
| DL04-12KN1-BRN1E-001 | 12W | typ.1400 | typ.120 | Y | ∅120x28 | ∅100 | 6.1kg | 20pcs |
| DL05-16KN1-BRN1E-001 | 16W | typ.1900 | typ.120 | Y | ∅145x28 | ∅125 | 7.4kg | 20pcs |
| DL06-20KN1-BRN1E-001 | 20W | typ.2400 | typ.120 | Y | ∅180x28 | ∅160 | 9.4kg | 20pcs |
| DL08-30KN1-BRN1E-001 | 30W | typ.3600 | typ.120 | Y | ∅225x28 | ∅200 | 6.8kg | 10pcs |



Bega Down Light Square shape

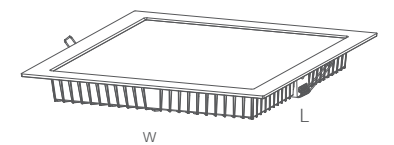

Bega Downlight use the die-cast case as the heating sink which make this down light offer higher lumen output.
Bega down light were widely used in various of different applications.

► Features

- > Die-cast housing as heat sink
- > Recessed installation
- > Full range dimension from 2.5 to 8 inches
- > Package: Standard or color box

► CCT Single Color Tri-color

► Function

► Electrical Parameters

► Photometric Parameters

► Dimension: 2.5 / 4 / 5 / 6 / 8 inches

► Finish White Black

► Data Sheet

| Order Code | Wattage | Lumen | LM/W | Flicker Free | Dimension (mm) | Cut-out(mm) | GW/CTN | QTY/CTN |
|----------------------|---------|----------|---------|--------------|-------------------|-------------|--------|---------|
| DL02-05GN1-BSN1E-001 | 5W | typ.450 | typ.90 | Y | L100 X W100 X H28 | 80x80 | 6.2kg | 20pcs |
| DL04-12KN1-BSN1E-001 | 12W | typ.1400 | typ.120 | Y | L120 X W120 X H28 | 100x100 | 7.0kg | 20pcs |
| DL05-16KN1-BSN1E-001 | 16W | typ.1900 | typ.120 | Y | L145 X W145 X H28 | 125x125 | 8.2kg | 20pcs |
| DL06-20KN1-BSN1E-001 | 20W | typ.2400 | typ.120 | Y | L180 X W180 X H28 | 160x160 | 10.6kg | 20pcs |
| DL08-30KN1-BSN1E-001 | 30W | typ.3600 | typ.120 | Y | L225 X W225 X H28 | 200x200 | 7.7kg | 10pcs |



Halo Down Light Round shape

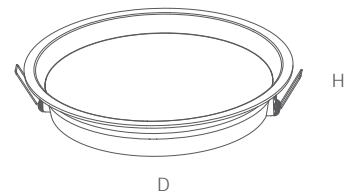

Halo Downlight, die casting aluminum housing design effectively reduce the UGR index. Interchangeable CCT with a slide switch is available.

► Features

- > Die-cast housing as heat sink
- > Recessed installation
- > Full range dimension from 2.5 to 8 inches
- > Package: Standard or color box

► CCT

► Function

► Electrical Parameters

► Photometric Parameters

► Dimension: 2.5 / 4 / 5 / 6 / 8 inches

► Finish

► Data Sheet

| Order Code | Wattage | Lumen | LM/W | Flicker Free | Dimension (mm) | Cut-out(mm) | GW/CTN | QTY/CTN |
|----------------------|---------|----------|---------|--------------|----------------|-------------|--------|---------|
| DL02-05GN1-HRN1E-001 | 5W | typ.450 | typ.90 | Y | ∅90x40 | ∅80 | 5.6kg | 20pcs |
| DL03-09KN1-HRN1E-001 | 9W | typ.1050 | typ.120 | Y | ∅120x40 | ∅105 | 6.8kg | 20pcs |
| DL04-12KN1-HRN1E-001 | 12W | typ.1440 | typ.120 | Y | ∅145x40 | ∅130 | 8.0kg | 20pcs |
| DL06-20KN1-HRN1E-001 | 20W | typ.2400 | typ.120 | Y | ∅175x40 | ∅160 | 10.5kg | 20pcs |
| DL08-30KN1-HRN1E-001 | 30W | typ.3600 | typ.120 | Y | ∅220x40 | ∅205 | 7.5kg | 10pcs |



Halo Down Light Square shape

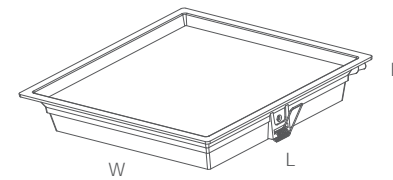

Halo Downlight, die casting aluminum housing design effectively reduce the UGR index. Interchangeable CCT with slide switch is available.

► Features

- > Die-cast housing as heat sink
- > Recessed installation
- > Full range dimension from 2.5 to 8 inches
- > Package: Standard or color box

► CCT

► Function

► Electrical Parameters

► Photometric Parameters

► Dimension: 2.5 / 4 / 5 / 6 / 8 inches

► Finish

► Data Sheet

| Order Code | Wattage | Lumen | LM/W | Flicker Free | Dimension (mm) | Cut-out(mm) | GW/CTN | QTY/CTN |
|----------------------|---------|----------|---------|--------------|-------------------|-------------|--------|---------|
| DL02-05GN1-HSN1E-001 | 5W | typ.450 | typ.90 | Y | L90 X W90 X H40 | 80x80 | 6.0kg | 20pcs |
| DL03-09KN1-HSN1E-001 | 9W | typ.1050 | typ.120 | Y | L120 X W120 X H40 | 105x105 | 7.6kg | 20pcs |
| DL04-12KN1-HSN1E-001 | 12W | typ.1440 | typ.120 | Y | L145 X W145 X H40 | 130x130 | 9.2kg | 20pcs |
| DL06-20KN1-HSN1E-001 | 20W | typ.2400 | typ.120 | Y | L170 X W170 X H40 | 160x160 | 11.5kg | 20pcs |
| DL08-30KN1-HSN1E-001 | 30W | typ.3600 | typ.120 | Y | L220 X W220 X H40 | 205x205 | 8.9kg | 10pcs |



EVO Down Light

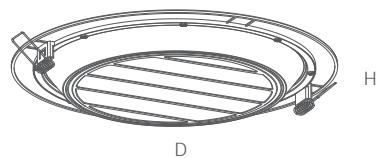

Evo down light is new cost-effective backlit down light. It uses the plastic and steel bottom case.

The Evo down light offers 6 different dimensions and function options.

This cost effective down light makes more and more clients interested in it and use it on different applications.

► Features

- > Cost-effective down light
- > Various of dimensions
- > Recessed Installation
- > Package: Standard or color box

► CCT Single Color 3000K 4000K 5000K 6000K

► Function   

► Electrical Parameters



► Photometric Parameters



► Data Sheet

| Order Code | Wattage | Lumen | LM/W | Flicker Free | Dimension (mm) | Cut-out(mm) | GW/CTN | QTY/CTN |
|----------------------|---------|----------|---------|--------------|----------------|-------------|--------|---------|
| PN09-04BN1-ENN1E-001 | 4W | typ.320 | typ.80 | Y | ∅90x25 | ∅72 | 7.5kg | 40pcs |
| PN12-08BN1-ENN1E-001 | 8W | typ.640 | typ.80 | Y | ∅120x25 | ∅107 | 5.2kg | 20pcs |
| PN17-12BN1-ENN1E-001 | 12W | typ.1200 | typ.100 | Y | ∅170x25 | ∅156 | 4.6kg | 10pcs |
| PN20-15BN1-ENN1E-001 | 15W | typ.1500 | typ.100 | Y | ∅200x25 | ∅185 | 5.3kg | 10pcs |
| PN24-18BN1-ENN1E-001 | 18W | typ.1980 | typ.110 | Y | ∅240x25 | ∅225 | 6.6kg | 10pcs |
| PN30-22BN1-ENN1E-001 | 22W | typ.2420 | typ.110 | Y | ∅300x25 | ∅280 | 9.0kg | 10pcs |



Slim Down Light

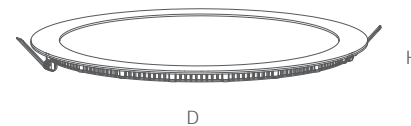

Slim Downlight is a round led panel light with an extra thin die-cast case. It uses the LGP as the light guide.

The 6 dimensions make the slim down widely used in various of different application.

► Features

- > Full range sizes are available
- > Recessed installation
- > Die casting aluminum case
- > Package: Standard or color box

► CCT Single Color 3000K 4000K 5000K 6000K

► Function   

► Electrical Parameters



► Photometric Parameters



► Data Sheet

| Order Code | Wattage | Lumen | LM/W | Flicker Free | Dimension (mm) | Cut-out(mm) | GW/CTN | QTY/CTN |
|----------------------|---------|----------|---------|--------------|----------------|-------------|--------|---------|
| PN09-04BN1-RNN1E-001 | 4W | typ.320 | typ.80 | Y | ∅88x25 | ∅65 | 7.5kg | 40pcs |
| PN12-08BN1-RNN1E-001 | 8W | typ.640 | typ.80 | Y | ∅120x25 | ∅105 | 5.2kg | 20pcs |
| PN17-12BN1-RNN1E-001 | 12W | typ.1200 | typ.100 | Y | ∅170x25 | ∅155 | 4.6kg | 10pcs |
| PN19-15BN1-RNN1E-001 | 15W | typ.1500 | typ.100 | Y | ∅190x25 | ∅175 | 5.3kg | 10pcs |
| PN24-18BN1-RNN1E-001 | 18W | typ.1980 | typ.110 | Y | ∅240x25 | ∅225 | 6.6kg | 10pcs |
| PN30-22BN1-RNN1E-001 | 22W | typ.2420 | typ.110 | Y | ∅300x25 | ∅275 | 9.0kg | 10pcs |



Tube light

/Series/

- > The LED tube is the best retrofit unit to replace the fluorescent tube. Toppo LED tube light has the T8/G13 LED tube which works for the inductive ballast, T6/G5 Led tube to replace the normal G5 fluorescent lamp.
- > The end cap of the led tube is rotatable with scale for easy installation, this makes manipulating beam direction simple by rotating the tube in a fitting.
- > The LED tube light are TUV/CE approved, which be widely used in different applications, such as: Schools, Supermarkets, Factories, Warehouses, Hospitals, Commercial & industrial applications.

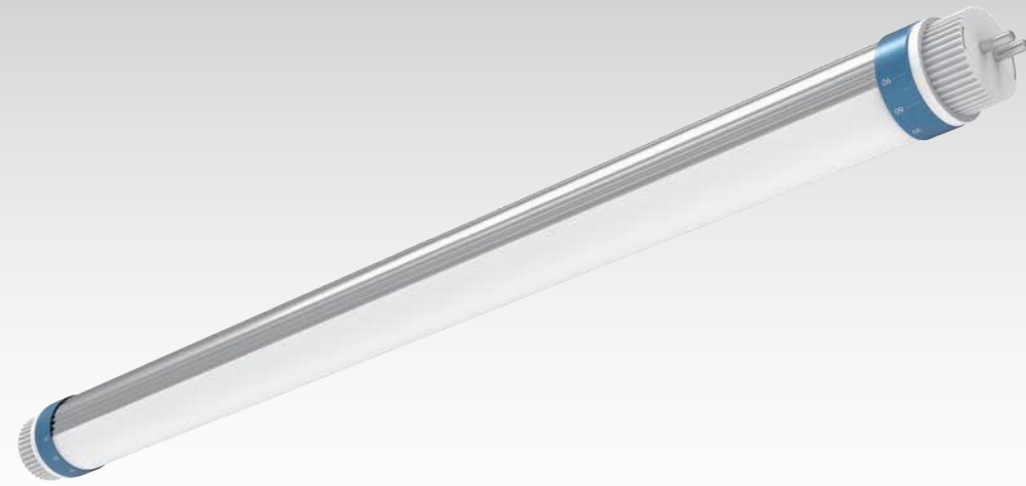

T8 LED Tube

Aluminum+PC | 160lm/w

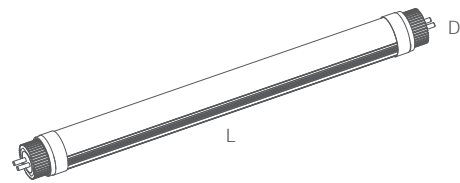

The T8 LED tube is often used with office lighting and warehouse applications and can be used in both indirect and parabolic light fixtures. The T8 tube with high lumen efficacy 160lm/w can save you more money. It's the best replacement for the fluorescent lamp.

► Features

- > TUV/CE/ROHS approval
- > Rotatable end cap
- > Up to 60% energy savings
- > 50,000 hours life span & 5 years warranty
- > Pink color for meat

- CCT Single Color **3000K** 4000K 5000K 6000K
- Function
- Electrical Parameters
 - AC 200-240V
 - PF ≥0.95
 - THD <15%
 - Flicker Free
- Photometric Parameters
 - 100/120 LM/W
 - 140/160 LM/W
 - CRI>80 SDCM <5
 - LM79 TM-21
 - ERP2.0
- Wiring
 - Single wiring
 - Double wiring

► Data Sheet

| Order Code | Rated Power | Lumen | LM/W | Flicker Free | Dimension (mm) | GW/CTN | QTY/CTN |
|----------------------|-------------|----------|---------|--------------|----------------|--------|---------|
| T802-10TN1-DCN1E-001 | 10W | typ.1600 | typ.160 | Y | L603 X D26 | 7.0kg | 25pcs |
| T803-12TN1-DCN1E-001 | 12W | typ.1920 | typ.160 | Y | L913 X D26 | 12.0kg | 25pcs |
| T804-18TN1-DCN1E-001 | 28W | typ.4480 | typ.160 | Y | L1212 X D26 | 12.5kg | 25pcs |
| T804-22TN1-DCN1E-001 | 22W | typ.3520 | typ.160 | Y | L1212 X D26 | 12.5kg | 25pcs |
| T805-22TN1-DCN1E-001 | 22W | typ.3520 | typ.160 | Y | L1513X D26 | 14.2kg | 25pcs |
| T806-30TN1-DCN1E-001 | 30W | typ.4800 | typ.160 | Y | L1813X D26 | 17.2kg | 25pcs |

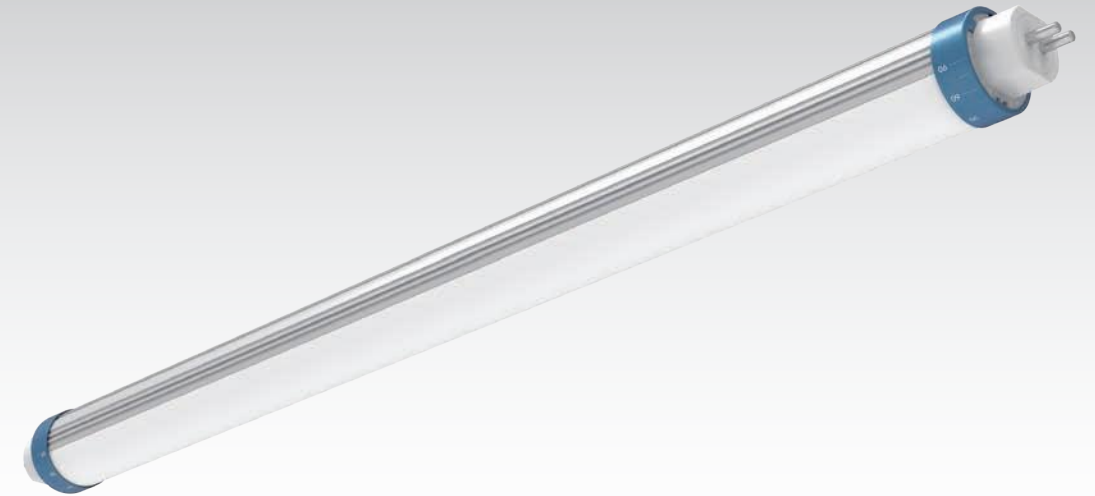

T6 LED Tube

Aluminum+PC | 160lm/w

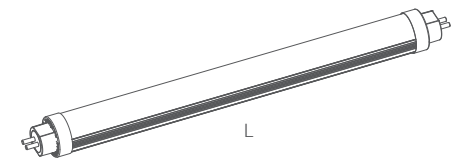

The T6 tube is the best replacement for the T5 fluorescent lamp. It is used with office lighting and warehouse applications and can be used in both indirect and parabolic light fixtures.

► Features

- > TUV/CE/ROHS approval
- > Rotatable end cap
- > Special Design for G5 cap
- > Up to 60% energy savings & 50,000 hours life span
- > Pink color for meat

- CCT Single Color **3000K** 4000K 5000K 6000K
- Function
- Electrical Parameters
 - AC 200-240V
 - PF ≥0.95
 - THD <15%
 - Flicker Free
- Photometric Parameters
 - 100/120 LM/W
 - 140/160 LM/W
 - CRI>80 SDCM <5
 - LM79 TM-21
 - ERP2.0
- Wiring
 - Single wiring
 - Double wiring

► Data Sheet

| Order Code | Rated Power | Lumen | LM/W | Flicker Free | Dimension (mm) | GW/CTN | QTY/CTN |
|----------------------|-------------|----------|---------|--------------|----------------|--------|---------|
| T602-10TN1-DCN1E-001 | 10W | typ.1600 | typ.160 | Y | L549 X D22 | 12.5kg | 50pcs |
| T604-18TN1-DCN1E-001 | 18W | typ.2880 | typ.160 | Y | L1148 X D22 | 12.5kg | 25pcs |
| T605-22TN1-DCN1E-001 | 22W | typ.3520 | typ.160 | Y | L1449 X D22 | 14.5kg | 25pcs |
| T605-25TN1-DCN1E-001 | 25W | typ.4000 | typ.160 | Y | L1449 X D22 | 14.5kg | 25pcs |
| T606-30TN1-DCN1E-001 | 30W | typ.4800 | typ.160 | Y | L1749 X D22 | 18.9kg | 25pcs |



Cabinet Light

Full plastic

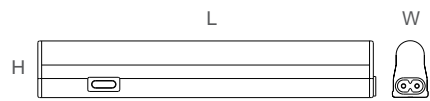

Cabinet lights were designed for use on cupboards, showcases, shopping malls.
Full plastic case and various of connectors make the cabinet light easy multiple link and easy installation.

Features

- > Ideal for retro-fit of existing T4 and T5 fixtures
- > Full set of connectors and accessories supplied
- > Slimline profile for discreet installation
- > Extruded plastic body
- > 3 years warranty

▶ CCT Single Color **3000K** 4000K 5000K 6000K

▶ Function

▶ Electrical Parameters



▶ Photometric Parameters



▶ Connector Accessories See below page

Data Sheet

| Order Code | Rated Power | Lumen | LM/W | Flicker Free | Dimension (mm) | GW/CTN | QTY/CTN |
|----------------------|-------------|----------|---------|--------------|-------------------|--------|---------|
| CB02-03GN1-AFN2J-001 | 3W | typ.300 | typ.100 | N | L200 X W23 X H37 | 15kg | 60pcs |
| CB03-05GN1-AFN2J-001 | 5W | typ.500 | typ.100 | N | L300 X W23 X H37 | 17kg | 60pcs |
| CB05-08GN1-AFN2J-001 | 8W | typ.800 | typ.100 | N | L500 X W23 X H37 | 10kg | 30pcs |
| CB09-14GN1-AFN2J-001 | 14W | typ.1400 | typ.100 | N | L900 X W23 X H37 | 13kg | 30pcs |
| CB12-16GN1-AFN2J-001 | 16W | typ.1600 | typ.100 | N | L1200 X W23 X H37 | 16kg | 30pcs |

Cabinet Light

Accessories





TPIUX

LED lighting
since 2009

TP-LUX branded High Power LED Lighting Series

- > TP-LUX branded products are the high power LED lightings which were designed and produced by Toppo Lighting high power lighting division.
- > TP-LUX branded high power lighting include: UFO highbay lights, Linear highbay lights, Modular highbay lights, Street lights, Shoe box lights, Post top lights, Bollard lights, Gas station lights and wall packs.
- > TP-LUX high power lightings are for worldwide marketing. It is very popular on north american and european market. All of the products have got the ETL /FCC /DLC /TUV-CE /SAA /Rohs /ERP2.0 licenses.
- > TP-LUX high power lightings focus on industrial and outdoor lighting applications. IP65 /IK08 are the standards for TP-LUX branded lighting.
- > TP-LUX branded high power lightings are all own molded products by Toppo Lighting, Various of patents of the design are available by Toppo Lighting.

TP LUX





UFO Highbay

/Series/

- >Toppo UFO Highbay Series offers a wide range of functionality, new innovative features and a modern and uniform design across the whole range.
- >The heatsink was designed for excellent heat dissipation as well as a modern appearance, while still being cost effective. All members of this series come with a competitive price and with 5 years warranty.
- >This Highbay series is available with 140lm/w, 160lm/w and 190lm/w system efficiency, different drivers and different optical features as well as various accessories like motion and daylight sensors and different mounting options.



Elite UFO

190lm/w

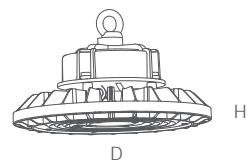

Elite UFO is a new functional highbay light, can use DIP switch wattage adjustable driver. Available on IP65 connector which make the Elite UFO easy for driver replace and AC wiring.
UP to 190lm/W makes the Elite UFO deliver the reliable lumen output and lower light decay.

Features

- > Up to 190lm/W and die-cast case as heat sink
- > Wattage DIP switch adjustable (60%/80%/100%) & Stepless adjustable are available
- > Ripple Lens: 60° / 90° / 120°
- > Plug & Play sensor for MS /on-off/1-10V changing is available
- > Optional on IP65 connector for smart driver replace AC wiring
- > D-Mark tested for using on paper / wooden production
- > 5 years warranty

Data Sheet

| Order Code | Rated Power | Wattage Adjustable | Lumen | LM/W | Flicker Free | Dimension (mm) | GW/CTN | QTY/CTN |
|----------------------|-------------|--------------------|-----------|---------|--------------|----------------|--------|---------|
| HB24-75FN1-ERN1L-000 | 75W | 45W/60W/75W | Max.14250 | typ.190 | Y | D240X H155 | 3.5kg | 1pcs |
| HB24-1AFN1-ERN1L-000 | 100W | 60W/80W/100W | Max.19000 | typ.190 | Y | D240X H155 | 3.5kg | 1pcs |
| HB28-1BFN1-ERN1L-000 | 150W | 90W/120W/150W | Max.28500 | typ.190 | Y | D280X H163 | 4.5kg | 1pcs |
| HB32-2AFN1-ERN1L-000 | 200W | 120W/160W/200W | Max.38000 | typ.190 | Y | D320X H163 | 5.3kg | 1pcs |



- ▶ CCT: Single Color (3000K, 4000K, 5000K, 6000K), Tri-color
- ▶ Function: ON/OFF, 1-10V Dimming, DALI, MS, Dimlight Sensor, Emergency
- ▶ Electrical Parameters: AC 100-277V, PF ≥0.95, THD <15%, Flicker Free
- ▶ Photometric Parameters: 160 LM/W, 190 LM/W, CRI>80 SDCM <5, LM79 TM-21, ERP2.0
- ▶ Beam angle: 60°, 90°, 120°
- ▶ IP/IK: IP65, IK10
- ▶ Installation: Loop Hanging, Hook Mounting, Ceiling Mounting, Bracket Mounting

Elite UFO

Function Options



DIP Switch Wattage Adjustable
Stepless Wattage Adjustable

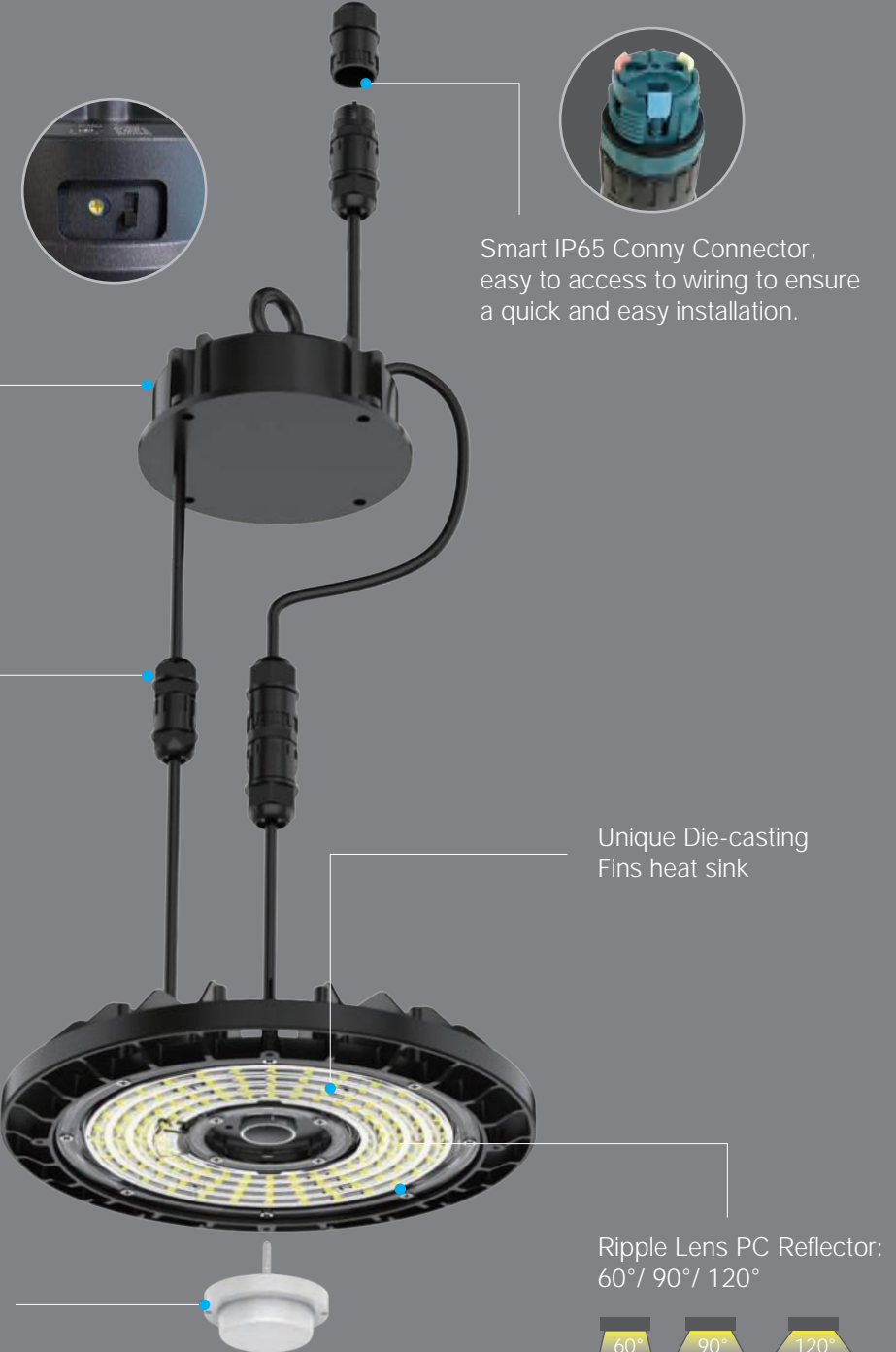

Plug in & Play MS Sensor, easy to change from MS to 1-10V.





Mate UFO Highbay



Mate UFO Honeycomb | UGR<22

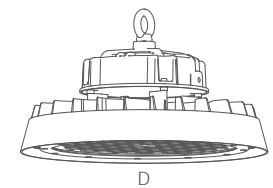

Honeycomb mate UFO is an anti-glare design with UGR<22, The lumen efficiency up to 160lm/W.
Sleek anti glare design and die cast heat sink make the mate UFO widely use suitable on glare applications, such as sports field, workshop, warehouse, etc.

► Features

- > Up to 160lm/W
- > Anti glare UGR<22
- > IP65 / IK10 for all industrial applications
- > Superior honeycomb-reflector-optic with 60° or 90°
- > L80/B10 @ 50.000h
- > D-Mark tested for use on paper / wooden production
- > Warranty: 5 years

► Data Sheet

| Order Code | Rated Power | Lumen | LM/W | Flicker Free | Dimension (mm) | GW/CTN | QTY/CTN |
|----------------------|-------------|-----------|---------|--------------|----------------|--------|---------|
| HB30-1ADN1-MHN5S-001 | 100W | typ.16000 | typ.160 | Y | D300X H155 | 4.3kg | 1pcs |
| HB30-1BDN1-MHN5S-001 | 150W | typ.24000 | typ.160 | Y | D300X H155 | 4.3kg | 1pcs |
| HB35-2ADN1-MHN5S-001 | 200W | typ.32000 | typ.160 | Y | D350X H155 | 5.6kg | 1pcs |
| HB35-2BDN1-MHN5S-001 | 240W | typ.38400 | typ.160 | Y | D350X H155 | 5.6kg | 1pcs |

- CCT Single Color **3000K** 4000K 5000K 6000K
- Function ON/OFF, 1-10V Dimming, DALI, MS, Daylight Sensor, Emergency, Low Glare
- Electrical Parameters AC 100-277V, PF ≥0.95, THD <15%, Flicker Free
- Photometric Parameters 140 LM/W, 160 LM/W, CRI>80 SDCM <5, LM79 TM-21, ERP2.0, UGR <22
- Beam angle 60°, 90°
- IP/IK IP65, IK10
- Installation Loop Hanging, Hook Mounting, Ceiling Mounting, Bracket Mounting



Mate UFO

180lm/w | Ripple Lens

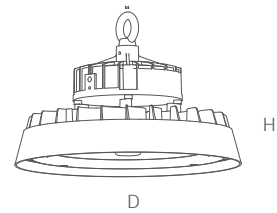

Ripple lens mate UFO provide 60°/ 90°/ 120° beam angle, High lumen output up to 180lm/W.

The different beam angle deliver the high Lux output, And the die-cast heat sink helps on the heating dissipation.

All of the above features make this UFO were widely use on different industrial applications.

Features

- > Up to 180lm/W
- > IP65 / IK10
- > Ripple lens optic with 60°/ 90°/ 120° beam angle
- > D-Mark tested for the using on paper / wooden production
- > 5 years warranty

Data Sheet

| Order Code | Rated Power | Lumen | LM/W | Flicker Free | Dimension (mm) | GW/CTN | QTY/CTN |
|----------------------|-------------|-----------|---------|--------------|----------------|--------|---------|
| HB30-1ATN1-MRN5S-001 | 100W | typ.18000 | typ.180 | Y | D300X H155 | 4.3kg | 1pcs |
| HB30-1BTN1-MRN5S-001 | 150W | typ.27000 | typ.180 | Y | D300X H155 | 4.3kg | 1pcs |
| HB35-2ATN1-MRN5S-001 | 200W | typ.36000 | typ.180 | Y | D350X H155 | 5.6kg | 1pcs |
| HB35-2BTN1-MRN5S-001 | 240W | typ.43200 | typ.180 | Y | D350X H155 | 5.6kg | 1pcs |

- ▶ CCT Single Color **3000K** 4000K 5000K 6000K
- ▶ Function
- ▶ Electrical Parameters
- ▶ Photometric Parameters
- ▶ Beam angle
- ▶ IP/IK
- ▶ Installation



Mate UFO

190lm/w | Glass Cover

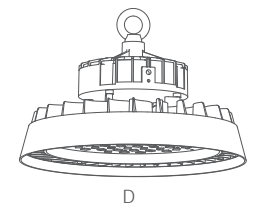

Glass cover mate UFO has a high lighting transmission. The lumen output reach at 190lm/W. The die-cast heat sink helps on the heating dissipation.

All of the above features make this UFO were widely use on different industrial applications.

Features

- > Up to 190lm/W
- > Die cast heat sink for heating dissipation
- > IP65 / IK10
- > D-Mark tested for using on paper / wooden production
- > 5 years warranty

Data Sheet

| Order Code | Rated Power | Lumen | LM/W | Flicker Free | Dimension (mm) | GW/CTN | QTY/CTN |
|----------------------|-------------|-----------|---------|--------------|----------------|--------|---------|
| HB30-1ATN1-MGN5S-001 | 100W | typ.19000 | typ.190 | Y | D300X H155 | 4.3kg | 1pcs |
| HB30-1BTN1-MGN5S-001 | 150W | typ.28500 | typ.190 | Y | D300X H155 | 4.3kg | 1pcs |
| HB35-2ATN1-MGN5S-001 | 200W | typ.38000 | typ.190 | Y | D350X H155 | 5.6kg | 1pcs |
| HB35-2BTN1-MGN5S-001 | 240W | typ.45600 | typ.190 | Y | D350X H155 | 5.6kg | 1pcs |

- ▶ CCT Single Color **3000K** 4000K 5000K 6000K
- ▶ Function
- ▶ Electrical Parameters
- ▶ Photometric Parameters
- ▶ IP/IK
- ▶ Installation

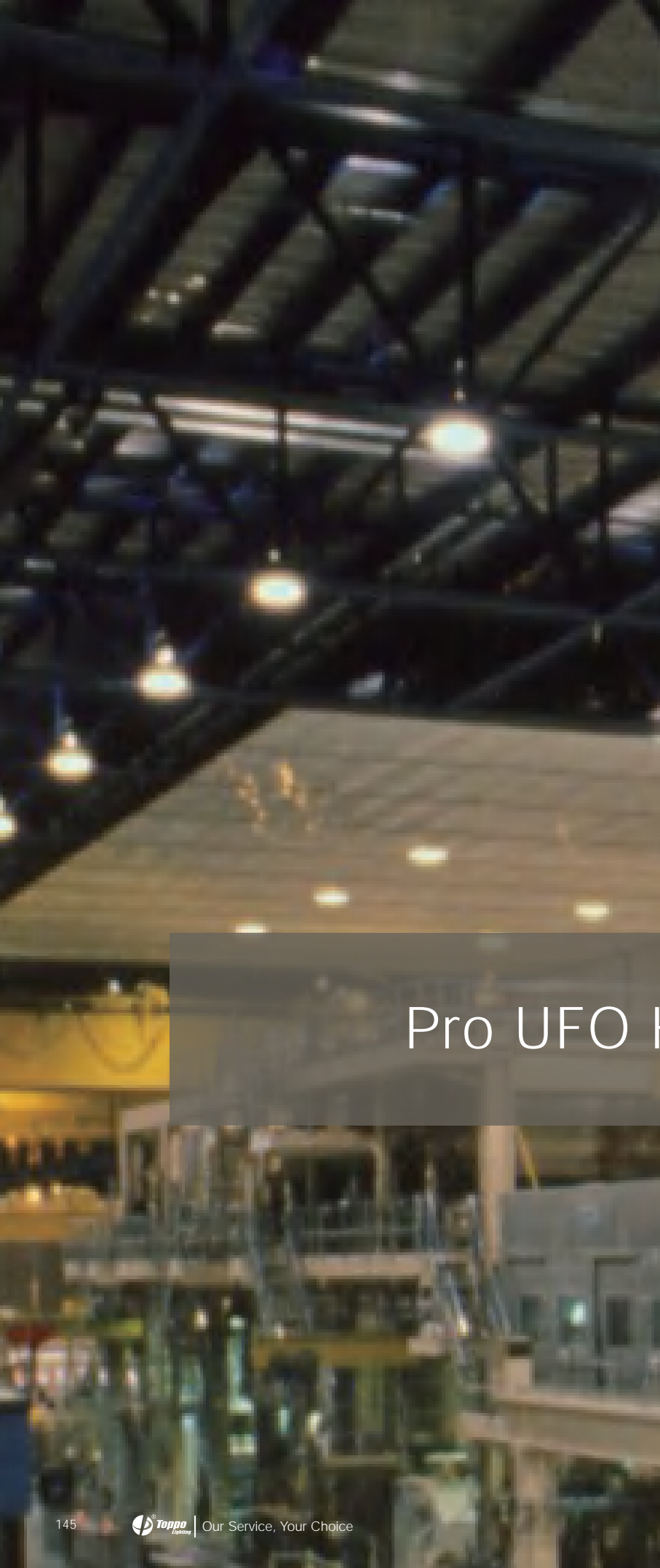

Pro UFO Highbay



Pro UFO

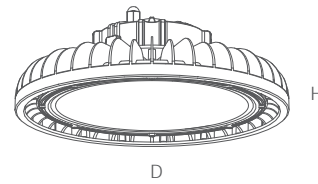

Pro UFO high bay is designed for the high wattage for 300W and 400W. The frosted PC cover make the Pro UFO has a uniform lighting emitting up to 150lm/W. The die-casting heat sink has super heat dissipation and the surface treatment adopts a powder spraying process. All the above features make the Pro UFO widely use on the industrial applications which need the high LUX and uniform lighting.

- ▶ Features
 - > Various function options
 - > UP to 150lm/W
 - > Die-cast heat sink for heating dissipation
 - > D-Mark tested for using on paper / wooden production
 - > 5 years warranty

▶ Data Sheet

| Order Code | Rated Power | Lumen | LM/W | Flicker Free | Dimension (mm) | GW/CTN | QTY/CTN |
|----------------------|-------------|-----------|---------|--------------|----------------|--------|---------|
| HB41-3APN1-PUV5E-001 | 300W | typ.45000 | typ.150 | Y | D410 X H220 | 6.5kg | 1pcs |
| HB41-4APN1-PUV5E-001 | 400W | typ.60000 | typ.150 | Y | D410 X H220 | 7.0kg | 1pcs |

- ▶ CCT Single Color 3000K 4000K 5000K 6000K
- ▶ Function
- ▶ Electrical Parameters
- ▶ Photometric Parameters
- ▶ IP/IK
- ▶ Installation



Linear Highbay

/Series/

- > TP-LUX branded linear highbay series designed to offer maximum efficacy, a long lifespan, glare protection, and a wide range of features.
- > The unique and modern appearance heatsink design assures excellent heat dissipation for up to 200W and up to 180lm/w system efficacy. All of our T-line Highbays are for a minimum of 5 years warranty.
- > The special designed Honeycomb Reflectors reduces glaring and provides various symmetric and asymmetric beam angle choices for all possible areas of applications.



Steel Linear Highbay

Steel Linear Highbay

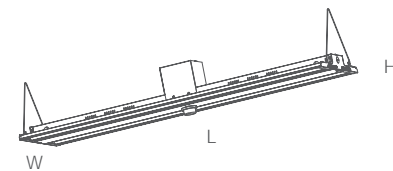

The steel linear highbay is a cost effective highbay light up to 150lm/W.

The frosted PC diffuser provide a glare protection. The hook junction box installation and suspension installation are available.

► Features

- > UP to 150lm/W
- > Frosted diffuser for glare protection
- > Steel case as heat sink
- > L80/B10 @ 50.000h
- > 5 years warranty

► Data Sheet

| Order Code | Rated Power | Lumen | LM/W | Flicker Free | Dimension (mm) | GW/CTN | QTY/CTN |
|----------------------|-------------|-----------|---------|--------------|--------------------|--------|---------|
| HB22-1BPN1-SFV5E-001 | 150W | typ.22500 | typ.150 | Y | L602 X W378 X H55 | 7.5kg | 1pcs |
| HB24-2BPN1-SFV5E-001 | 250W | typ.37500 | typ.150 | Y | L1182 X W378 X H55 | 13.0kg | 1pcs |
| HB24-3APN1-SFV5E-001 | 300W | typ.45000 | typ.150 | Y | L1182 X W378 X H55 | 13.0kg | 1pcs |

► CCT

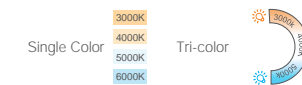

► Function



► Electrical Parameters



► Photometric Parameters



► Installation



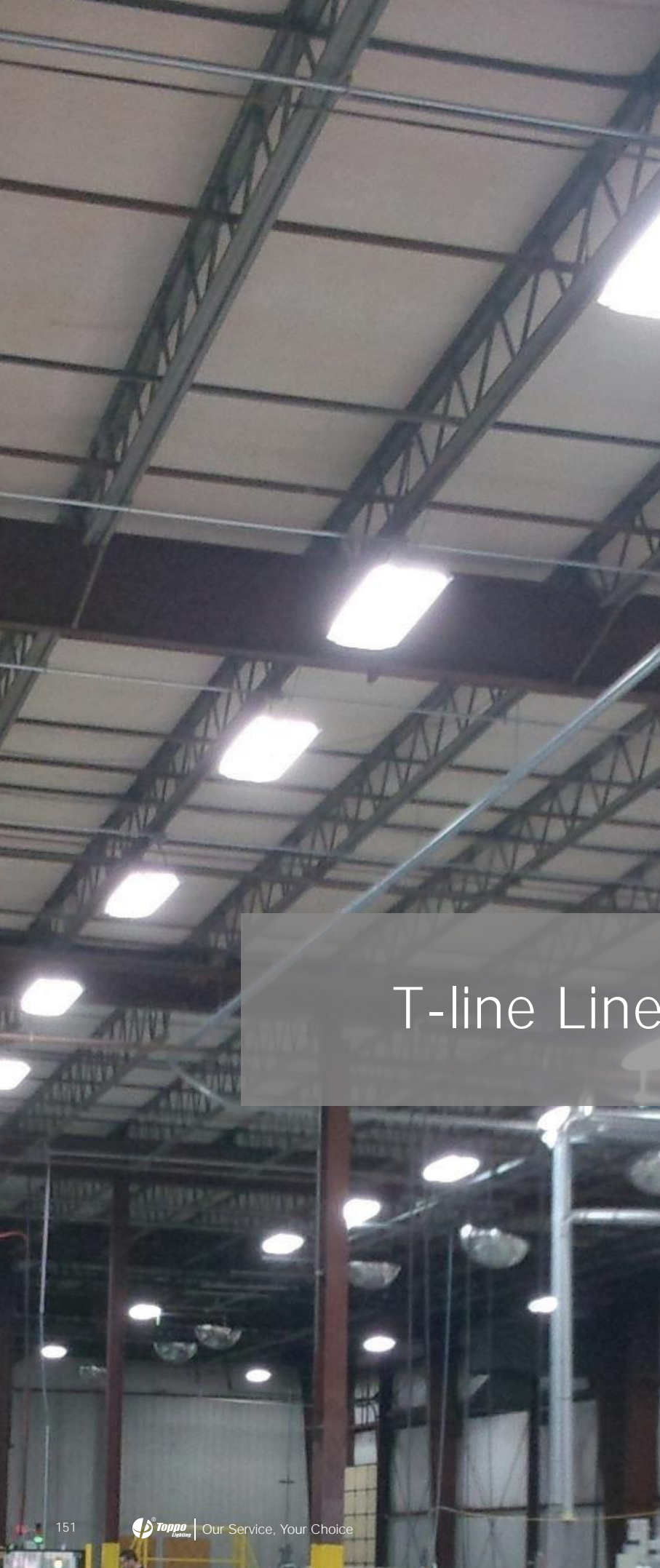

T-line Linear Highbay



T-line Linear Highbay

Symmetric Honeycomb

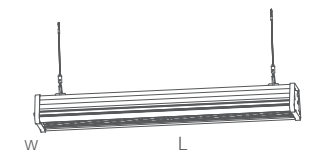

The symmetric honeycomb linear highbay is designed low glare applications up to 160lm/W. The symmetric honeycomb provide 60/90° degree beam angle.

The superior honeycomb-reflector-optic for low glare make this linear highbay be widely use on the industrial and commercial applications which need the low glare lighting emitting.

► Features

- > Up to 160lm/W
- > Die-cast case for excellent heat dissipation
- > Symmetric honeycomb for low glare
- > No UV or IR and completely mercury free
- > Various end cap colors available
- > L80/B10 @ 50.000h
- > 5 years warranty

► Data Sheet

| Order Code | Rated Power | Lumen | LM/W | Flicker Free | Dimension (mm) | GW/CTN | QTY/CTN |
|----------------------|-------------|-----------|---------|--------------|--------------------|--------|---------|
| LB02-1ADN1-TSN5S-001 | 100W | typ.16000 | typ.160 | Y | L623 X W138 X H73 | 5.9kg | 1pcs |
| LB03-1CDN1-TSN5S-001 | 120W | typ.19200 | typ.160 | Y | L923 X W138 X H73 | 7.9kg | 1pcs |
| LB03-1BDN1-TSN5S-001 | 150W | typ.24000 | typ.160 | Y | L923 X W138 X H73 | 7.9kg | 1pcs |
| LB04-2ADN1-TSN5S-001 | 200W | typ.32000 | typ.160 | Y | L1223 X W138 X H73 | 10.0kg | 1pcs |

- CCT
 - Single Color: 3000K, 4000K, 5000K, 6000K
 - Tri-color: 3000K, 4000K, 5000K
- Function
 - ON/OFF
 - 1-10V Dimming
 - DALI
 - MS
 - Daylight Sensor
 - Emergency
- Electrical Parameters
 - AC 100-277V
 - PF ≥0.95
 - THD <15%
 - Flicker Free
- Photometric Parameters
 - 140 LM/W
 - 160 LM/W
 - CRI>80 SDCM <5
 - LM79 TM-21
 - ERP2.0
 - UGR <22
- Beam angle
 - 60°
 - 90°
- IP/IK
 - IP65
 - IK10



T-line Linear Highbay

Asymmetric Honeycomb

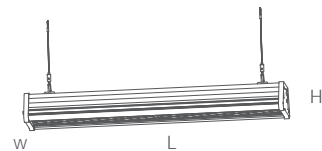

The asymmetric honeycomb linear highbay provide the 60x110° and 90x110° degree beam angle. The asymmetric angle make the UFO deliver a uniform lighting up to 160lm/W.

The asymmetric honeycomb reflector also make the linear highbay UGR<22 low glare.

► Features

- > Up to 160lm/W
- > Die-cast case for excellent heat dissipation
- > Asymmetric honeycomb for low glare UGR<22
- > No UV or IR and completely mercury free
- > Various end cap colors available
- > L80/B10 @ 50.000h
- > 5 years warranty

► CCT

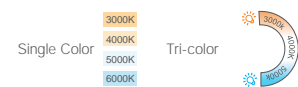

► Function



► Electrical Parameters



► Photometric Parameters



► Beam angle

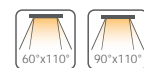

► IP/IK

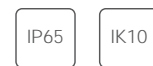

► Data Sheet

| Order Code | Rated Power | Lumen | LM/W | Flicker Free | Dimension (mm) | GW/CTN | QTY/CTN |
|----------------------|-------------|-----------|---------|--------------|--------------------|--------|---------|
| LB02-1ATN1-TAN5S-001 | 100W | typ.16000 | typ.160 | Y | L623 X W138 X H73 | 5.9kg | 1pcs |
| LB03-1CTN1-TAN5S-001 | 120W | typ.19200 | typ.160 | Y | L923 X W138 X H73 | 7.9kg | 1pcs |
| LB03-1BTN1-TAN5S-001 | 150W | typ.24000 | typ.160 | Y | L923 X W138 X H73 | 7.9kg | 1pcs |
| LB04-2ATN1-TAN5S-001 | 200W | typ.32000 | typ.160 | Y | L1223 X W138 X H73 | 10.0kg | 1pcs |



T-line Linear Highbay

Glass Cover

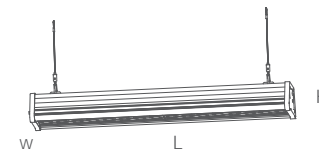

The glass cover linear highbay provide frosted and clear version up to 180lm/W.

The cooling fins aluminum case assures the excellent heating dissipation.

► Features

- > Frosted: 170lm/W, Clear: 180lm/W
- > Die-cast case for excellent heat dissipation
- > No UV or IR and completely mercury free
- > Various end cap colors available
- > L80/B10 @ 50.000h
- > 5 years warranty

► CCT

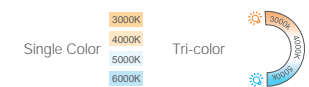

► Function



► Electrical Parameters



► Photometric Parameters



► IP/IK

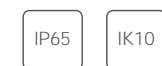

► Data Sheet

| Order Code | Rated Power | Lumen | LM/W | Flicker Free | Dimension (mm) | GW/CTN | QTY/CTN |
|----------------------|-------------|-----------|---------|--------------|--------------------|--------|---------|
| HB02-1ATN1-TFN5S-001 | 100W | typ.17000 | typ.170 | Y | L623 X W138 X H73 | 5.9kg | 1pcs |
| HB03-1CTN1-TFN5S-001 | 120W | typ.20400 | typ.170 | Y | L923 X W138 X H73 | 7.9kg | 1pcs |
| HB03-1BTN1-TFN5S-001 | 150W | typ.25500 | typ.170 | Y | L923 X W138 X H73 | 7.9kg | 1pcs |
| HB04-2ATN1-TFN5S-001 | 200W | typ.34000 | typ.170 | Y | L1223 X W138 X H73 | 10.0kg | 1pcs |



Modular Highbay

/Series/

- > TP-LUX branded modular highbay is a custom-made dimension highbay which use the 60CM / 90CM / 120CM T-Line unit as the basic unit.
- > The symmetric, Asymmetric, Glass cover offer the different lighting emitting for the modular highbay on different beam angle.
- > The own design aluminum heat sink deliver the best heating dissipation for modular highbay which make the highbay offer a long life span and lower light decay.
- > The special designed Honeycomb Reflectors reduces glaring and provides various symmetric and asymmetric beam angle choices for all possible areas of applications.

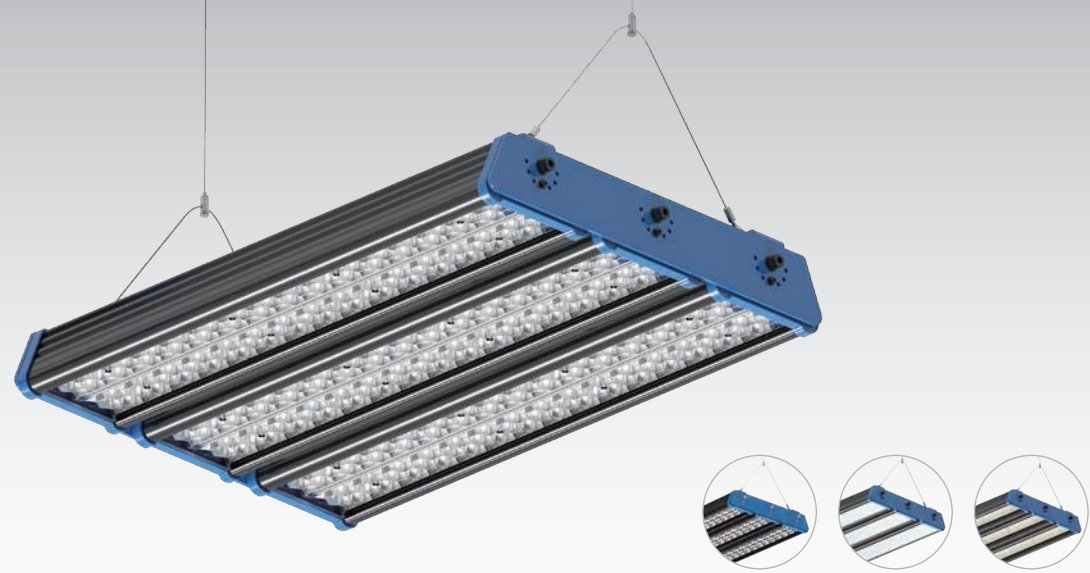

Modular Highbay

3x100W-60cm | 180lm/w

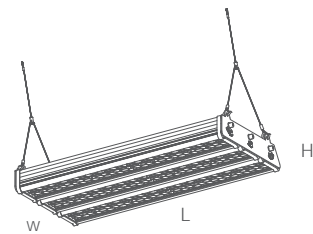

Modular highbay use the 60CM / 90CM / 120CM T-Line unit as the basic unit. Aluminum heat sink deliver the best heating dissipation which make the highbay offer a long life span and lower light decay.

The special designed Honeycomb reflectors reduces glaring and provides various symmetric and asymmetric beam angle choices for all possible areas of applications.

Features

- > Superior honeycomb-reflector-optic for low glare
- > Asymmetric Honeycomb reflector for 60°90° degree
- > Glass cover up to 180lm/W
- > Cooling-finings structure for excellent heat dissipation
- > L80/B10 @ 50.000h
- > 5 years warranty

- ▶ CCT: Single Color (3000K, 4000K, 5000K, 6000K), Tri-color
- ▶ Function: ON/OFF, 1-10V Dimming, DALI, MS, Daylight Sensor, Emergency
- ▶ Electrical Parameters: AC 100-277V, PF ≥0.95, THD <15%, Flicker Free
- ▶ Photometric Parameters: 140 LM/W, 160 LM/W, 180 LM/W, CRI>80 SDCM <5, LM79 TM-21, ERP2.0
- ▶ Cover: Symmetric honeycomb, Asymmetric honeycomb, Glass cover
- ▶ Beam angle: 60°, 90°, 60°x110°, 90°x110°, 120° (Symmetric Honeycomb, Asymmetric Honeycomb, Glass)
- ▶ IP/IK: IP65, IK10

Data Sheet

| Order Code | Rated Power | Lumen | LM/W | Flicker Free | Dimension (mm) | GW/CTN | QTY/CTN |
|----------------------|-------------|-----------|---------|--------------|-------------------|--------|---------|
| HB02-3AAN1-MSN5S-001 | 300W | typ.48000 | typ.160 | Y | L624 X W438 X H83 | 15.6kg | 1pcs |
| HB02-3ATN1-MAN5S-001 | 300W | typ.48000 | typ.160 | Y | L624 X W438 X H83 | 15.6kg | 1pcs |
| HB02-3ATN1-MFN5S-001 | 300W | typ.51000 | typ.170 | Y | L624 X W438 X H83 | 15.6kg | 1pcs |
| HB02-3ATN1-MGN5S-001 | 300W | typ.54000 | typ.180 | Y | L624 X W438 X H83 | 15.6kg | 1pcs |

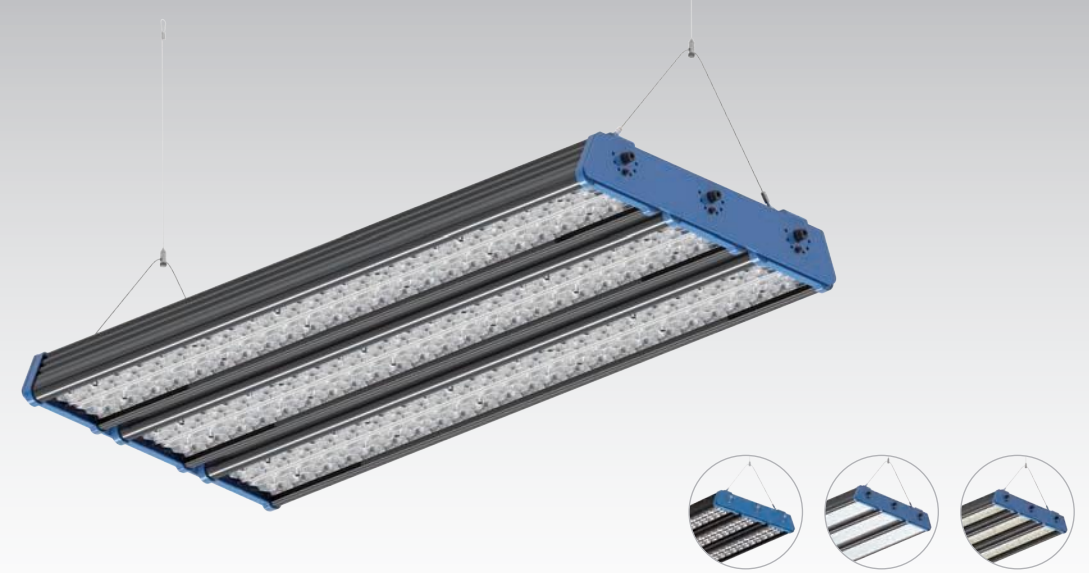

Modular Linear Highbay

3x150W-90cm | 180lm/w

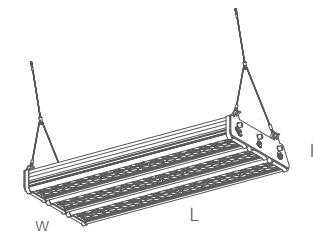

Modular highbay use the 60CM / 90CM / 120CM T-Line unit as the basic unit. Aluminum heat sink deliver the best heating dissipation which make the highbay offer a long life span and lower light decay.

The special designed Honeycomb reflectors reduces glaring and provides various symmetric and asymmetric beam angle choices for all possible areas of applications.

Features

- > Superior honeycomb-reflector-optic for low glare
- > Asymmetric Honeycomb reflector for 60°90° degree
- > Glass cover up to 180lm/W
- > Cooling-finings structure for excellent heat dissipation
- > L80/B10 @ 50.000h
- > 5 years warranty

- ▶ CCT: Single Color (3000K, 4000K, 5000K, 6000K), Tri-color
- ▶ Function: ON/OFF, 1-10V Dimming, DALI, MS, Daylight Sensor, Emergency
- ▶ Electrical Parameters: AC 100-277V, PF ≥0.95, THD <15%, Flicker Free
- ▶ Photometric Parameters: 140 LM/W, 160 LM/W, 180 LM/W, CRI>80 SDCM <5, LM79 TM-21, ERP2.0
- ▶ Cover: Symmetric honeycomb, Asymmetric honeycomb, Glass cover
- ▶ Beam angle: 60°, 90°, 60°x110°, 90°x110°, 120° (Symmetric Honeycomb, Asymmetric Honeycomb, Glass)
- ▶ IP/IK: IP65, IK10

Data Sheet

| Order Code | Rated Power | Lumen | LM/W | Flicker Free | Dimension (mm) | GW/CTN | QTY/CTN |
|----------------------|-------------|-----------|---------|--------------|-------------------|--------|---------|
| HB03-4BTN1-MSN5S-001 | 450W | typ.72000 | typ.160 | Y | L924 X W438 X H83 | 19.5kg | 1pcs |
| HB03-4BTN1-MAN5S-001 | 450W | typ.72000 | typ.160 | Y | L924 X W438 X H83 | 19.5kg | 1pcs |
| HB03-4BTN1-MFN5S-001 | 450W | typ.76500 | typ.170 | Y | L924 X W438 X H83 | 19.5kg | 1pcs |
| HB03-4BTN1-MGN5S-001 | 450W | typ.81000 | typ.180 | Y | L924 X W438 X H83 | 19.5kg | 1pcs |

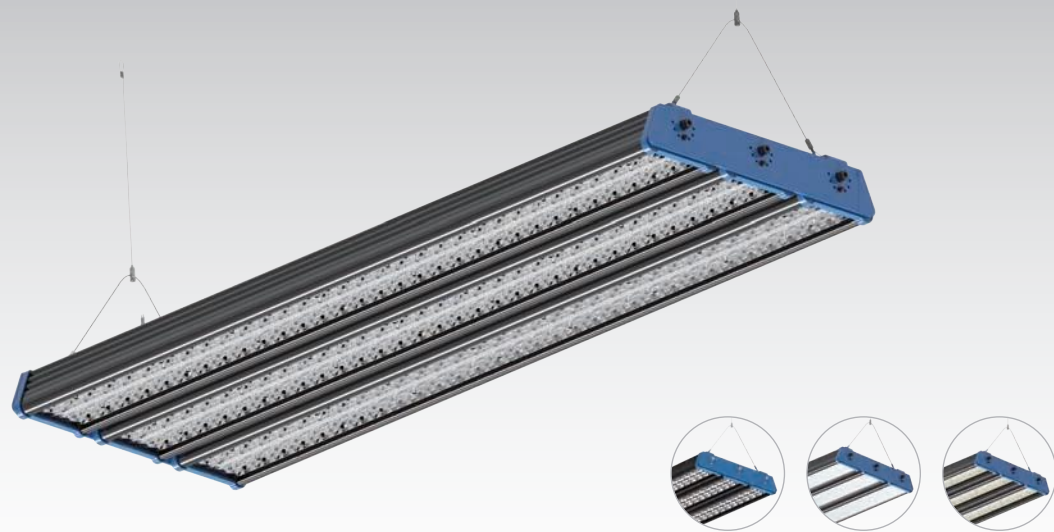

Modular Linear Highbay

3x200W-120cm | 180lm/w

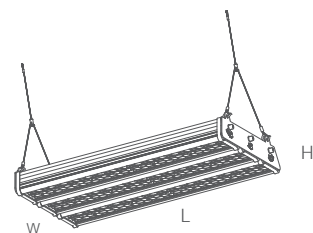

Modular highbay use the 60CM / 90CM / 120CM T-Line unit as the basic unit. Aluminum heat sink deliver the best heating dissipation which make the highbay offer a long life span and lower light decay.

The special designed Honeycomb reflectors reduces glaring and provides various symmetric and asymmetric beam choices for all possible areas of applications.

Features

- > Superior honeycomb-reflector-optic for low glare
- > Asymmetric Honeycomb reflector for 60°/90° degree
- > Glass cover up to 180lm/w
- > Cooling-finings structure for excellent heat dissipation
- > L80/B10 @ 50.000h
- > 5 years warranty

Data Sheet

| Order Code | Rated Power | Lumen | LM/W | Flicker Free | Dimension (mm) | GW/CTN | QTY/CTN |
|----------------------|-------------|------------|---------|--------------|--------------------|--------|---------|
| HB04-6ATN1-MSN5S-001 | 600W | typ.96000 | typ.160 | Y | L1224 X W438 X H83 | 25.2kg | 1pcs |
| HB04-6ATN1-MAN5S-001 | 600W | typ.96000 | typ.160 | Y | L1224 X W438 X H83 | 25.2kg | 1pcs |
| HB04-6ATN1-MFN5S-001 | 600W | typ.102000 | typ.170 | Y | L1224 X W438 X H83 | 25.2kg | 1pcs |
| HB04-6ATN1-MGN5S-001 | 600W | typ.108000 | typ.180 | Y | L1224 X W438 X H83 | 25.2kg | 1pcs |

- ▶ CCT: Single Color (3000K, 4000K, 5000K, 6000K), Tri-color (Warm White, Neutral White, Cool White)
- ▶ Function: ON/OFF, 1-10V Dimming, DALI, MS, Daylight Sensor, Emergency
- ▶ Electrical Parameters: AC 100-277V, PF ≥0.95, THD <15%, Flicker Free
- ▶ Photometric Parameters: 140 LM/W, 160 LM/W, 180 LM/W, CRI>80 SDCM <5, LM79 TM-21, ERP2.0
- ▶ Cover: Symmetric honeycomb, Asymmetric honeycomb, Glass cover
- ▶ Beam angle: Symmetric Honeycomb (60°, 90°), Asymmetric Honeycomb (60°x110°, 90°x110°), Glass (120°)
- ▶ IP/IK: IP65, IK10

Modular Highbay product family

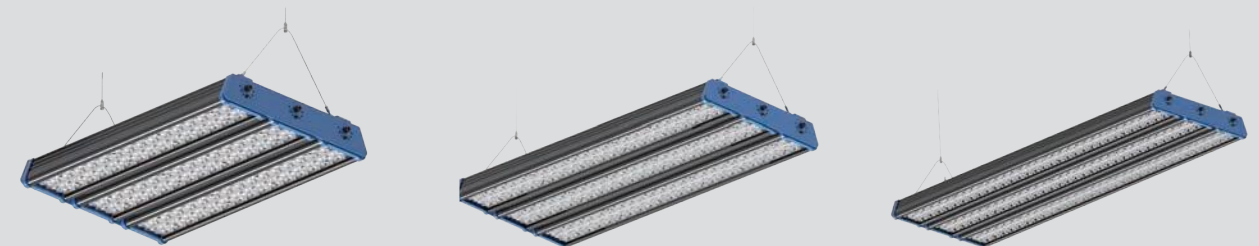

Modular Linear Highbay
3X60CM

Modular Linear Highbay
3X90CM

Modular Linear Highbay
3X120CM

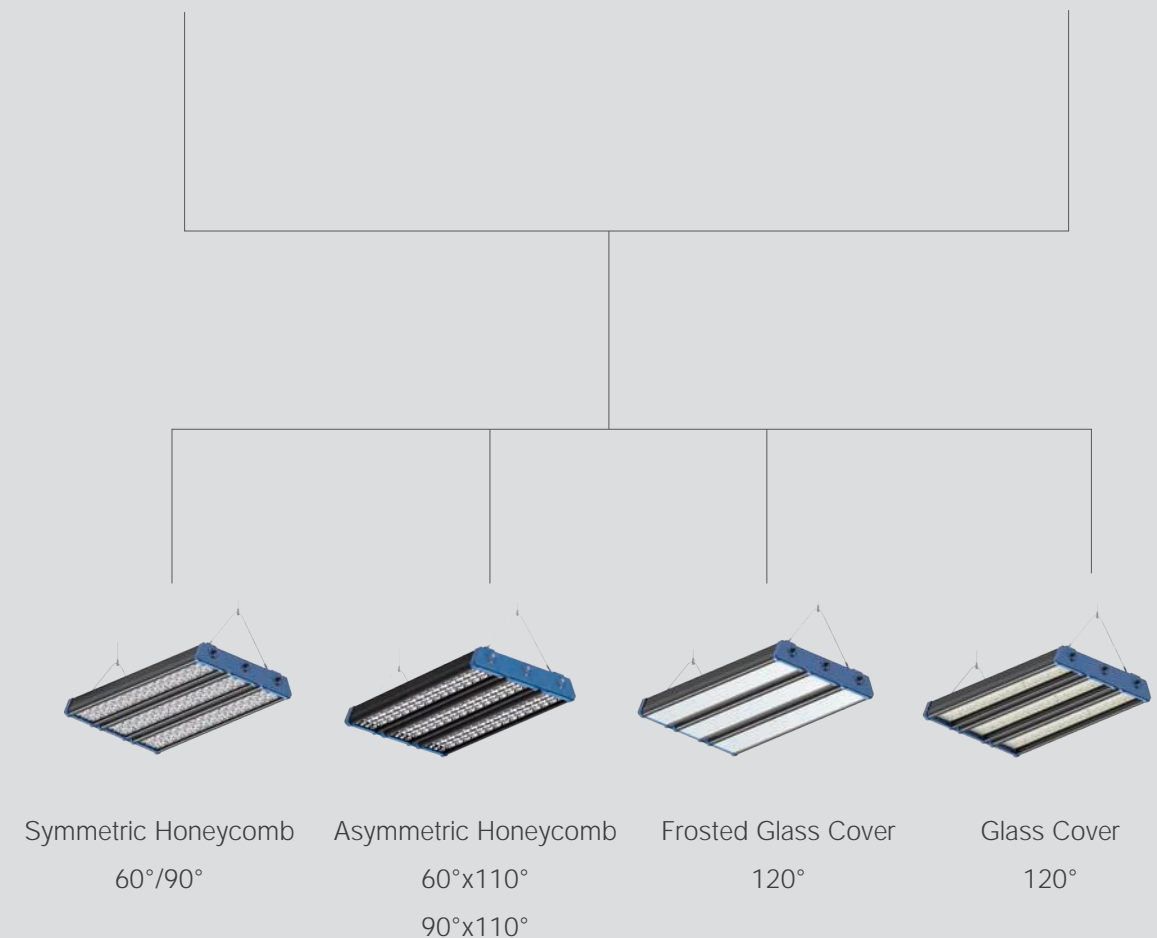

Symmetric Honeycomb
60°/90°

Asymmetric Honeycomb
60°x110°
90°x110°

Frosted Glass Cover
120°

Glass Cover
120°



Street Light Shoe Box

/Series/

- > The street light and shoebox light is a very popular outdoor lighting series. Toppo design this series lighting by the new technology and best cost effective.
- > T2 and T3 Asymmetric lens provide the different angle which makes the street light and shoe box light deliver the different lighting emitting base on different applications.
- > Wattage adjustable, CCT changing, 1-10V dimming are the standard function. IP65 waterproof and IK10 vibration rate is the standard structure desing.
- > Toppo TP-Lux branded street light and shoe box have got the good reputation from the worldwide customer from the American and European.



Fasco Street Light

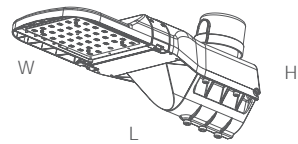

The fasco street light include 50W and 75W@150lm/W. T2 and T3 lens are available for different beam angle, Fasco street light are for the applications of illumination systems along roadways, primarily for the purpose of improving safety by increasing visibility of roadside hazards and by reducing the effects of glare from other light sources in the visual environment, such as vehicle headlamps.

► Features

- > UP to 150lm/W
- > Die-cast aluminum as heat sink
- > Surge protection: L/N-PE: 10kV, L-N: 6kV
- > Flicker free
- > 8 years warranty

► Data Sheet

| Order Code | Rated Power | Lumen | LM/W | Flicker Free | Dimension (mm) | GW/CTN | QTY/CTN |
|----------------------|-------------|-----------|---------|--------------|--------------------|--------|---------|
| SL01-50VN1-FAV5E-001 | 50W | typ.7500 | typ.150 | Y | L425 X W200 X H188 | 3.2kg | 1pcs |
| SL01-75VN1-FAV5E-001 | 75W | typ.11250 | typ.150 | Y | L425 X W200 X H188 | 3.2kg | 1pcs |

- CCT
 - Single Color: 3000K, 4000K, 5000K, 6000K
 - Tri-color
- Function
 - ON/OFF
 - 1-10V Dimming
 - Daylight Sensor
- Electrical Parameters
 - AC 100-277V
 - AC 100-384V
 - PF ≥0.95
 - THD <15%
 - Flicker Free
- Photometric Parameters
 - 130 LM/W
 - 150 LM/W
 - CRI>80 SDCM <5
 - LM79 TM-21
 - ERP2.0
- Lens
 - T2
 - T3
- IP/IK
 - IP65
 - IK10



Masco Street Light

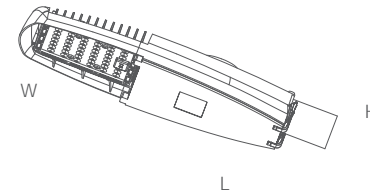

The masco street light include 100W, 120W, 150W @150lm/W. T2 and T3 lens are available for different beam angle, Masco street light are for the applications of illumination systems along roadways, primarily for the purpose of improving safety by increasing visibility of roadside hazards and by reducing the effects of glare from other light sources in the visual environment, such as vehicle headlamps.

► Features

- > UP to 150lm/W
- > Die-cast aluminum as heat sink
- > Surge protection: L/N-PE: 10kV, L-N: 6kV
- > Flicker free
- > 8 years warranty

► Data Sheet

| Order Code | Rated Power | Lumen | LM/W | Flicker Free | Dimension (mm) | GW/CTN | QTY/CTN |
|----------------------|-------------|-----------|---------|--------------|--------------------|--------|---------|
| SL02-1AVN1-MAV5E-001 | 100W | typ.15000 | typ.150 | Y | L487 X W309 X H143 | 17.5kg | 1pcs |
| SL02-1CVN1-MAV5E-001 | 120W | typ.18000 | typ.150 | Y | L487 X W309 X H143 | 21.5kg | 1pcs |
| SL01-1BVN1-MAV5E-001 | 150W | typ.25500 | typ.150 | Y | L487 X W309 X H143 | 21.5kg | 1pcs |

- CCT
 - Single Color: 3000K, 4000K, 5000K, 6000K
 - Tri-color
- Function
 - ON/OFF
 - 1-10V Dimming
 - Daylight Sensor
- Electrical Parameters
 - AC 100-277V
 - AC 100-384V
 - PF ≥0.95
 - THD <15%
 - Flicker Free
- Photometric Parameters
 - 130 LM/W
 - 150 LM/W
 - CRI>80 SDCM <5
 - LM79 TM-21
 - ERP2.0
- Lens
 - T2
 - T3
- IP/IK
 - IP65
 - IK10



Dasco Shoebox



Dasco Shoebox | 100/150W

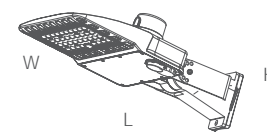

Dasco shoebox is a lens modular light on different wattage. It include 100W / 150W / 240W / 300W up to 150lm/W. T2 and T3 lens are available for different beam angle.

Dasco shoebox be used for outdoor applications such as providing illumination to parkings, streets, highways, and other areas. They are also ideal for replacing the halogen fixtures.

► Features

- > UP to 150lm/W
- > Lens modular for different wattage
- > Smart function on MS and daylight senso
- > Surge protection: L/N-PE: 10kV, L-N: 6kV
- > Flicker free
- > 5 years warranty

► Data Sheet

| Order Code | Rated Power | Lumen | LM/W | Flicker Free | Dimension (mm) | GW/CTN | QTY/CTN |
|----------------------|-------------|-----------|---------|--------------|-------------------|--------|---------|
| SX01-1AVP1-DAV5E-001 | 100W | typ.15000 | typ.150 | Y | L334 X W317 X H75 | 5.4kg | 1pcs |
| SX01-1BVP1-DAV5E-001 | 150W | typ.22500 | typ.150 | Y | L334 X W317 X H75 | 5.4kg | 1pcs |

- CCT
 - Single Color: 3000K, 4000K, 5000K, 6000K
 - Tri-color: 3000K, 4000K, 5000K
- Function
 - ON/OFF
 - 1-10V Dimming
 - MS
 - Daylight Senso
- Electrical Parameters
 - AC 100-277V
 - AC 100-384V
 - PF ≥0.95
 - THD <15%
 - Flicker Free
- Photometric Parameters
 - 130 LM/W
 - 150 LM/W
 - CRI>80 SDCM <5
 - LM79 TM-21
 - ERP2.0
- Lens
 - T2
 - T3
- IP/IK
 - IP65
 - IK10



Dasco Shoebox | 240W

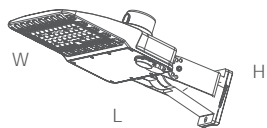

Dasco shoebox is a lens modular light on different wattage. It include 100W / 150W / 240W / 300W up to 150lm/W. T2 and T3 lens are available for different beam angle.

Dasco shoebox be used for outdoor applications such as providing illumination to parkings, streets, highways, and other areas. They are also ideal for replacing the halogen fixtures.

► Features

- > UP to 150lm/W
- > Lens modular for different wattage
- > Smart function on MS and daylight senso
- > Surge protection: L/N-PE: 10kV, L-N: 6kV
- > Flicker free
- > 5 years warranty

► CCT

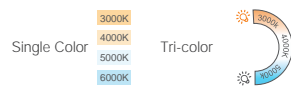

► Function



► Electrical Parameters



► Photometric Parameters



► Lens



► IP/IK



► Data Sheet

| Order Code | Rated Power | Lumen | LM/W | Flicker Free | Dimension (mm) | GW/CTN | QTY/CTN |
|----------------------|-------------|-----------|---------|--------------|------------------|--------|---------|
| SX01-2BVP1-DAV5E-001 | 240W | typ.36000 | typ.150 | Y | L455X W317 X H75 | 6.1kg | 1pcs |



Dasco Shoebox | 300W

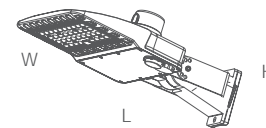

Dasco shoebox is a lens modular light on different wattage. It include 100W / 150W / 240W / 300W up to 150lm/W. T2 and T3 lens are available for different beam angle.

Dasco shoebox be used for outdoor applications such as providing illumination to parkings, streets, highways, and other areas. They are also ideal for replacing the halogen fixtures.

► Features

- > UP to 150lm/W
- > Lens modular for different wattage
- > Smart function on MS and daylight senso
- > Surge protection: L/N-PE: 10kV, L-N: 6kV
- > Flicker free
- > 5 years warranty

► CCT



► Function



► Electrical Parameters



► Photometric Parameters



► Lens



► IP/IK



► Data Sheet

| Order Code | Rated Power | Lumen | LM/W | Flicker Free | Dimension (mm) | GW/CTN | QTY/CTN |
|----------------------|-------------|-----------|---------|--------------|------------------|--------|---------|
| SX01-3AVP1-DAV5E-001 | 300W | typ.45000 | typ.150 | Y | L579 X W85 X H73 | 8.2kg | 1pcs |



Posttop Light



Posttop Light 80/100/150w

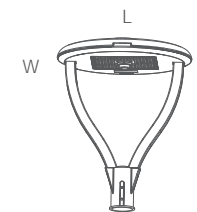

The posttop is a free standing exterior light fixture in gardens and landscaped settings. They are usually illuminated by electricity, but occasionally natural gas, and are usually placed near an outdoor path or driveway to provide visibility in dark areas or areas that become dark at certain times.

► Features

- > UP to 150lm/W
- > Surge protection: L/N-PE: 10kV, L-N: 6kV
- > Easy Installation
- > Flicker free
- > 5years warranty

► Data Sheet

| Order Code | Rated Power | Lumen | LM/W | Flicker Free | Dimension (mm) | GW/CTN | QTY/CTN |
|----------------------|-------------|-----------|---------|--------------|--------------------|--------|---------|
| PT01-80VN1-REV5E-001 | 80W | typ.12000 | typ.150 | Y | L510 X W544 X H634 | 3.2kg | 1pcs |
| PT01-1AVN1-REV5E-001 | 100W | typ.15000 | typ.150 | Y | L510 X W544 X H634 | 3.2kg | 1pcs |
| PT01-1BVN1-REV5E-001 | 150W | typ.22500 | typ.150 | Y | L510 X W544 X H634 | 3.2kg | 1pcs |

► CCT

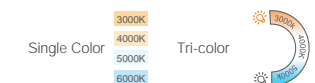

► Function



► Electrical Parameters



► Photometric Parameters



► Lens



► IP/IK





Bollard Light Wall Pack

Orwell Bollard Light

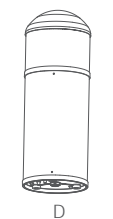

The bollard light is a free standing exterior light fixture in gardens and landscaped settings. They are usually illuminated by electricity, but occasionally natural gas, and are usually placed near an outdoor path or driveway to provide visibility in dark areas or areas that become dark at certain times.

► Features

- > Dome, flat and peak tops for option
- > High quality extrusion aluminum body
- > Stainless steel silicone rubber sealing
- > IP66 rated for wet location
- > High lumen output at 125lm/W
- > Easy Installation
- > Flicker free & 5 years warranty

► Data Sheet

| Order Code | Rated Power | Lumen | LM/W | Flicker Free | Dimension (mm) | GW/CTN | QTY/CTN |
|----------------------|-------------|----------|---------|--------------|------------------|--------|---------|
| BL01-38KN1-OWV5E-001 | 38W | typ.4750 | typ.125 | Y | D184.5 X W1052.5 | 5.8kg | 1pcs |

► CCT

Single Color: 3000K, 4000K, 5000K, 6000K
Tri-color: 3000K, 4000K, 5000K

► Function

ON/OFF, 1-10V Dimming, MS, Daylight Sensor

► Electrical Parameters

AC 100-277V, AC 100-384V, PF ≥0.95, THD <15%, Flicker Free

► Photometric Parameters

125 LM/W, CRI>80 SDCM <5, LM79 TM-21, ERP2.0

► IP/IK

IP66, IK10



Burwell Bollard Light

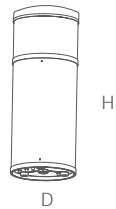

The bollard light is a free standing exterior light fixture in gardens and landscaped settings. They are usually illuminated by electricity, but occasionally natural gas, and are usually placed near an outdoor path or driveway to provide visibility in dark areas or areas that become dark at certain times.

► Features

- > Dome, flat and peak tops for option
- > High quality extrusion aluminum body
- > Stainless steel silicone rubber sealing
- > IP66 rated for wet location
- > High lumen output at 125lm/W
- > Easy Installation
- > Flicker free & 5 years warranty

► Data Sheet

| Order Code | Rated Power | Lumen | LM/W | Flicker Free | Dimension (mm) | GW/CTN | QTY/CTN |
|----------------------|-------------|----------|---------|--------------|------------------|--------|---------|
| BL01-38KN1-BWV5E-001 | 38W | typ.4750 | typ.125 | Y | D184.5 X W1052.5 | 5.8kg | 1pcs |



► CCT

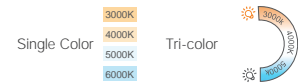

► Function



► Electrical Parameters



► Photometric Parameters



► IP/IK

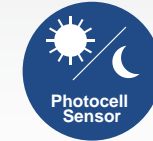

Wall Pack WP01

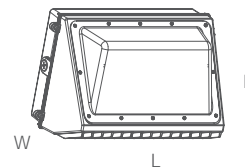

The LED Wall Pack Light is great for commercial and security lighting purposes where the light will need to operate for long periods of time. Their bright light output and adjustable mount design make them an ideal choice for illuminating building perimeters where control of spill light is important.

► Features

- > Various of functions for options
- > High lumen output at 130lm/W
- > Surge protection: L/N-PE: 5kV, L-N: 5kV
- > Easy Installation
- > Flicker free
- > 5 years warranty

► Data Sheet

| Order Code | Rated Power | Lumen | LM/W | Flicker Free | Dimension (mm) | GW/CTN | QTY/CTN |
|----------------------|-------------|-----------|---------|--------------|--------------------|--------|---------|
| WP01-50KN1-REV5E-001 | 50W | typ.6500 | typ.130 | Y | L363 X W235 X H196 | 2.8kg | 1pcs |
| WP01-75KN1-REV5E-001 | 75W | typ.9750 | typ.130 | Y | L363 X W235 X H196 | 3.4kg | 1pcs |
| WP01-1AKN1-REV5E-001 | 100W | typ.13000 | typ.130 | Y | L363 X W235 X H196 | 3.7kg | 1pcs |

► CCT

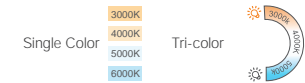

► Function



► Electrical Parameters



► Photometric Parameters



► IP/IK



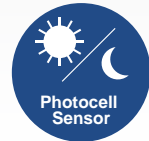

Wall Pack

WP02

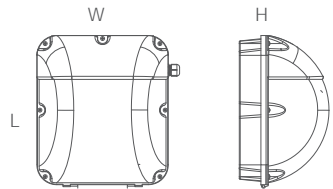

The LED Wall Pack Light is great for commercial and security lighting purposes where the light will need to operate for long periods of time. Their bright light output and adjustable mount design make them an ideal choice for illuminating building perimeters where control of spill light is important.

► Features

- > Various of functions for options
- > High lumen output at 130lm/W
- > Surge protection: L/N-PE: 5kV, L-N: 5kV
- > Easy Installation
- > Flicker free
- > 5 years warranty

► CCT Single Color 3000K 4000K 5000K 6000K Tri-color 2700K-6500K

► Function ON/OFF 1-10V Dimming

► Electrical Parameters

| | | | | | |
|-------------|-------------|-----------|----------|----------|--------------|
| AC 100-277V | AC 100-384V | Grounding | PF ≥0.95 | THD <15% | Flicker Free |
|-------------|-------------|-----------|----------|----------|--------------|

► Photometric Parameters

| | | | |
|----------|----------------|------------|--------|
| 130 LM/W | CRI>80 SDCM <5 | LM79 TM-21 | ERP2.0 |
|----------|----------------|------------|--------|

► IP/IK IP65 IK10

► Data Sheet

| Order Code | Rated Power | Lumen | LM/W | Flicker Free | Dimension (mm) | GW/CTN | QTY/CTN |
|----------------------|-------------|----------|---------|--------------|--------------------|--------|---------|
| WP02-40KN1-REV5E-001 | 40W | typ.5200 | typ.130 | Y | L308 X W265 X H182 | 2.8kg | 1pcs |



Gas Station Light



Gas Station Light

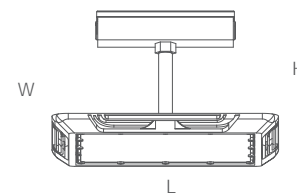

The gas station light lights to feature compact die-cast construction, sturdy mechanism, and reliable quality with IP65 & IK10 respectively. It has a long life of 50,000 hours and 5 years warranty.



Features

- > Various of functions for options
- > Reliable LED driver and high efficacy LED chips
- > Surge protection: L/N-PE: 5kV, L-N: 5kV
- > Easy Installation
- > Flicker free
- > 5 years warranty



Data Sheet

| Order Code | Rated Power | Lumen | LM/W | Flicker Free | Dimension (mm) | GW/CTN | QTY/CTN |
|----------------------|-------------|-----------|---------|--------------|--------------------|--------|---------|
| GS01-1BPN1-REV5E-001 | 150W | typ.19500 | typ.130 | Y | L430 X W430 X H282 | 6.0kg | 1pcs |

▶ CCT Single Color 3000K 4000K 5000K 6000K

▶ Function  

▶ Electrical Parameters AC 100-277V AC 100-384V  PF ≥0.95 THD <15% Flicker Free

▶ Photometric Parameters 130 LM/W CRI>80 SDCM <5 LM79 TM-21 ERP2.0

▶ IP/IK IP65 IK10

LED Technical Glossary

Ampere (Amp)- The unit for measuring rate of flow of electrical current: Current(Amps)= Power(Watts)/Voltage(Volts)

1-10V Analogue dimming- Local dimming option for LED luminaires. Requires a dimming pair of cables to be run to each driver in the circuit

Beam Angle- The spread of light from a luminaire. For example: a fitting such as a low bay, which is closer to the floor, will have a wider beam angle to illuminate a given floor area while a high bay fitting will have a narrower beam

Brightness-Often used incorrectly with respect to illumination as a synonym for luminous flux. An objective measurement of the visible power of a light source. The term is correctly used when describing screen brightness in a display or television

Colour Rendering Index(CRI)-A measure of the degree of colour shift objects undergo when illuminated by the light source as compared with those same objects when illuminated by a reference source of comparable colour temperature. The reference source has a CRi of 100

Colour temperature -The description used to describe the effect of heating an object until it glows incandescently. The emitted radiation, and apparent colour, changes proportional to the temperature; easily envisioned when considering hot metal in a forge that glows red, then orange, and then white as the temperature increases

Day lighting harvesting- Dimming of luminaire output to take advantage of available natural light and reduce energy consumption

Delivered Light -The amount of light a lighting fixture or lighting installation delivers to a target area or task surface, measured in footcandles (fc)or lux(lx)

Diffuser - An object with irregularities on a surface causing scattered light diffusion

Digital Addressable Lighting Interface (DALI)-a digital communications protocol for controlling and dimming lighting fixtures, originally developed in Europe

Dual Wattage - Option to select the power output of the driver

Efficacy -The light output of a light source divided by the total electrical power input to that source, expressed in lumens per watt(lm/W)

Electrical class 1/2/3 - Electrical protection classes are used to differentiate between the protective-earth connection requirements of devices. The level of protection ranges from: Class 1 being the lowest protection and class 3 being the highest protection

Fire Rating categories:

VO - Burning stops within 10 seconds on vertical specimen; drips of particles allowed as long as they are not inflamed

V2-Burning stops within 30 seconds on vertical specimen; drip of particles allowed as long as they are not inflamed

HB- Slow burning on a horizontal specimen burning rate <76mm/min thickness <3mm or burning stops before 100mm

TP(b)-Slow burning rate <50mm/min for thickness <3mm

TP(a)-Self extinguishes and flaming and afterglow should not exceed 5 seconds once source the source of flame is removed

Flux/Luminous Flux- Luminous flux is the measure of the perceived power of light produced by the LED adjusted to reflect the varying sensitivity of the human eye to different wavelengths of light

Forward voltage - LEDs are current driven devices. If an external current is passed through the device, a forward voltage will be developed across the diode

Hazardous Zone 1&2- Are defined as places where fire or explosion hazards may exist due to flammable gases, flammable liquid-produced vapours, combustible liquid produced vapours,

combustible dusts, or ignitable fibres/ flying present in the air in quantities sufficient to produce explosive or ignitable mixtures

Heat Sink -A part of the thermal system that conducts or convects heat away from sensitive components, such as LEDs and electronics

High Power LED- A high power LED, sometimes referred to as a power LED, is one that is driven at a current of 350 mA or higher

ICEL-Industry Committee for Emergency Lighting

IES -A photometric data file for use with lighting design software

IK Rating- Classifies and rates the degree of protection provided against mechanical impact

Illuminance- The intensity of light falling on a surface area. If the area is measured in square feet, the unit of illuminance is footcandles (fc). If measured in squar metres, the unit of illuminance is lux(lx)

Ingress Protection(IP)-Classifies and rates the degree of protection provided against Intrusion(body parts such as hands and fingers), dust, accidental contact, and water by mechanical casings and electrical enclosures

Inrush current- Inrush current is the briefly occurring high nput current which flows into the electronic control gear during the initial start-up to charge the capacitors on the input side. Typically, the amplitude is much greater than the operating or steady-state current

ISO 9001- Accredited quality management system

ISO 14001- Accredited environmental management system

Kelvin Temperature- Term and symbol (K) used to indicate the comparative colour appearance of a light source when compared to a theoretical blackbody Yellowish incandescent lamps are 3000K

L70- The number of hours of use at which the lumens output is 70% of its value at installation. Eg L70 at 50,000 hours

LED Chip(Chip)- The light producing semiconductor device that may or may not be incorporated into an LED

LED Driver- An electronic circuit that converts input power into a current source- a source in which current remains constant despite fluctuations in voltage. An LED driver protects LEDs from normal voltage fluctuations overvoltages, and voltage spikes

LGP(PMMA)-A key component to maximize the uniformity of light, to make the backlight slim and to reorient the line or dot light source such as LED to the plate light source

Li-ion- Lithium-ion battery. A type of re-chargeable battery

LiFePO4- Lithium-ion rechargable battery intended for high power applications

Light Emitting Diode (LED)- A Light Emitting Diode (LED) is a solid-state semiconductor device that converts electrical energy directly into light. At its most basic level the semiconductor is comprised of two regions. The p-region contains positive electrical charges while the n-region contains negative electrical charges. When voltage is applied and current begins to flow, the electrons move across the n region into the p region.The process of an electron moving through the p-n junction releases energy. The dispersion of this energy produces photons with visible wavelengths

Lumen(lm)- The international (SI) unit of luminous fluX

or quantity of light and equals the amount of light that is spread over a square foot of surface by one candle power when all parts of the surface are exactly one foot from the light source

Lumen Output- The total lumens emitted of a light source, system, or solution

Luminaire- A lighting fixture complete with installed lamps and other accessories

Luminous Efficacy- Luminous efficacy is a measure of how well a light source produces visible light expressed as Lumens/Watt

Lux(lx)- The international (Si) unit of illuminance, or luminous flux incident on a unit area, frequently defined as one lumen per square meter (lm/mg²)

Maintained Emergency- Luminaire available for general lighting and emergency lighting

NCF- Non-corrosive fitting or weather proof fitting

NiCd- Nickel-Cadmium battery. A type of re-chargeable battery
Non-Maintained- Luminaire available for emergency lighting only

Polymethylmethacrylate (PMMA)- A clear plastic material that can be used as a replacement for glass Commonly used in places where shatter-proof glass or windows are required

Power Factor- The active power divided by the apparent power (i.e, product of the rms input voltage and rms input current of a driver)

Smart Lighting- Automated Lighting Control using sensors and/or scheduling switches

SMDS- Surface-mount LEDS

Thermoplastic- A material with a relatively low softening point. Diffusers used in LED lighting products will be rate to show that they have fire retardant properties. Examples of fire ratings include TP(a), TP(b), VO and HB

Tri-Color- Option to select the the color temperature of some white light Toppo Lighting products

UGR- Unified Glare Rating

Ultraviolet (UV)- Electromagnetic radiation with wavelength shorter than that of visible light

Volt- The term used to describe the electrical potential difference between oppositely charged conductors

Watt- The unit of electrical power as used by an electrical device during its operation Many lamps come with rating in watts to indicate their power consumption

ZigBee- A low-power, low data rate, local area wireless network, ideal for lighting control

IP Ratings Explained

IP Ratings are defined as a number IP XX indicating the level of ingress protection provided by the luminaire enclosure

IP ratings are defined as IPXX where the first X indicates the degree of protection against solid objects and the second X indicates the degrees of protection against water. A luminaire or lighting component with a rating of IP66 is dust-tight and protected against powerful water jets

Degrees of Protection Against Solid Objects

| | |
|------|------------------------------|
| IPOX | Non-protecte |
| IPIX | 50mm diameter and greater |
| IP2X | 12.55mm diameter and greater |
| IP3X | 2. 5mm diameter and greater |
| IP4X | 1.0mm diameter and greater |
| IP5X | Dust-protected |
| IP6X | Dust-tight |

Degrees of Protection Against Water

| | |
|------|------------------------------------------------------|
| IPX0 | Non-protected |
| IPX1 | Vertically falling water drops |
| IPX2 | Vertically falling water drops with enclosure tilted |
| IPX3 | Spraying water |
| IPX4 | Splashing water |
| IPX5 | Water jets |
| IPX6 | Powerful water jets |
| IPX7 | Temporary immersion |
| IPX8 | Continuous immersion |

IK Ratings Explained

IK Ratings are defined as a number Ik XX indicating the level of impact protection provided by the luminaire enclosure The IK Rating scale identifies the ability of an enclosure to resist impact energy levels measured in joules (J) IEC 62262 specifies how the enclosure must be mounted for testing, the atmospheric conditions required, the quantity and distribution of the test impacts and the impact hammer to be used for each level of IK rating

| IKOO | IKO2 | IKO3 | KO5 | KO6 | KO7 | KO8 | | K10 |
|----------------------|-------------|--------------|-------------|-------------|-----------|-----------|------------|------------|
| Non-protected | 0.2J | 0.35J | 0.5J | 0.7J | 2J | 5J | 10J | 20J |

