



# 产品规格书

## SPECIFICATION

产品名称Product name: A1608橙色A01HH-E001-0.60T

产品编码Product Code: E6Z1608SEAC1-A01HH-0.60T-E001

产品老编码Old Code: (E6Z1608SEAC1UDA)

文件编号 Document. NO: YJY-GGS-H1608-E001

版次 REV NO: V 3.0

描述 Description:

- 1.6×0.8×0.55贴片发光二极管1.6×0.8×0.55Chip SMD
- 胶体颜色Colloid Color: 无色透明 Water Transparent
- 发光颜色Emission Color: 橙光 Orange light
- 半功率角度Viewing Angle :120°

亿晶源光电 Ekinglux			客户承认 Client	
工程 Engingeering	品保 QA	业务 Sell	承认 Accept	盖章 Affirm



### 1. 外形尺寸Dimensions

单位(Units):毫米(mm)

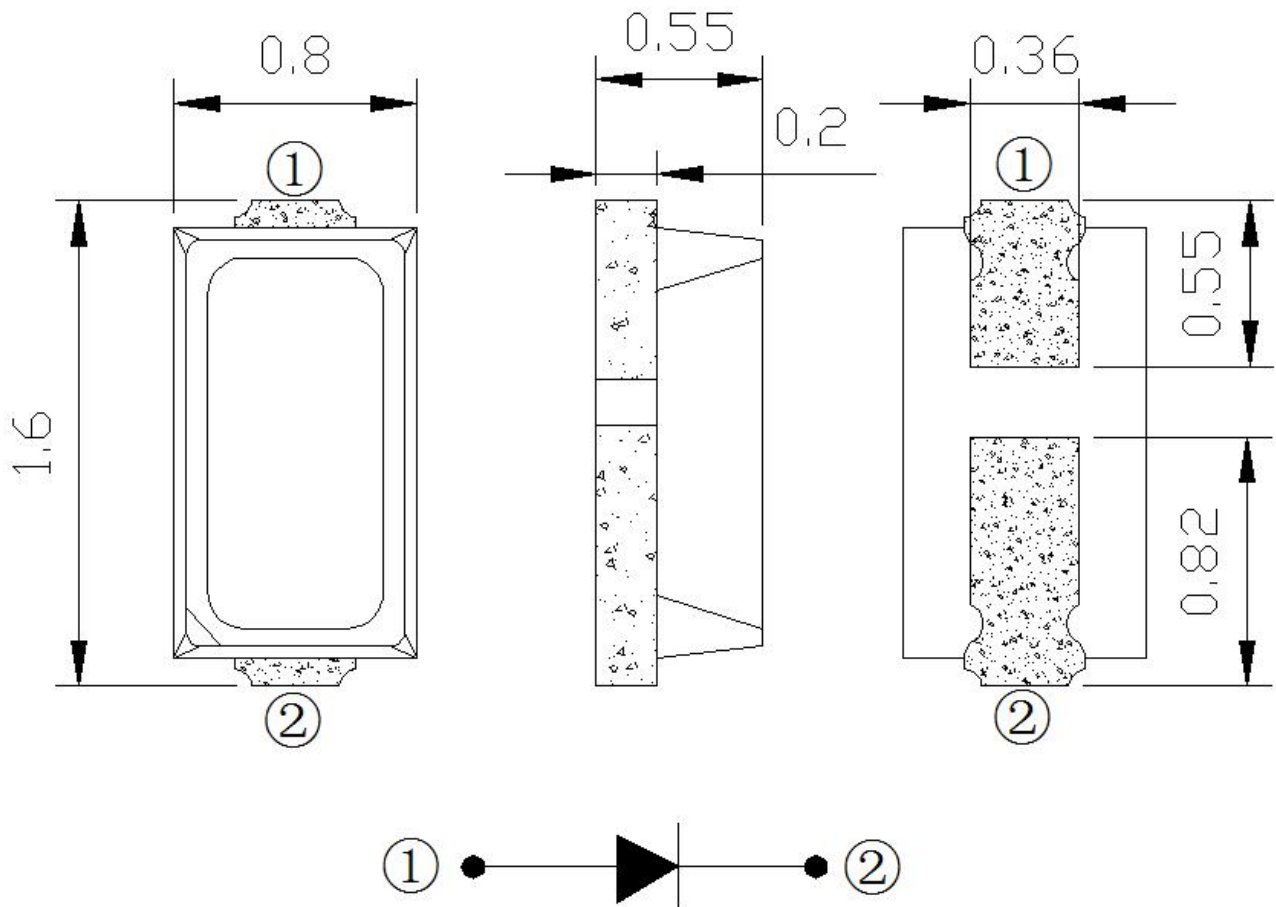

注意所有尺寸单位为mm，如无特殊说明误差范围为±0.05mm

All dimensions area in mm tolerance is ±0.05mm unless otherwise noted. tes:



### 2. 光电特性 Electrical/Optical characteristics

(1) 最大限度额定值 Absolute Maximum Ratings (TA=25°C)

项目 Item	符号 Symbol	最大绝对额定值 Absolute Maximum Rating		单位 Unit
		Orange		
正向电流 Forward Current	IF	25		mA
正向峰值电流 Pulse Forward Current	IFP	60		mA
反向电压 Reverse Voltage	VR	5		V
功率消耗 Power Dissipation	PD	55		mW
工作温度 Operating Temperature	Topr	-40°C To +85°C		° C
贮藏温度 Storage Temperature	Topr	-40°C To +85°C		° C
焊接温度 Soldering Temperature	Tslid	Reflow Soldering 回流焊接 : 245°C		for 10sec.
		Hand Soldering 手工焊接 : 350°C		for 3sec

1/10周期, 0.1 msec脉宽

IFP Conditions : 1/10 Duty Cycle, 0.1 msec Pulse Width

(2) 本样品光电参数 Initial Electrical/Optical Characteristics (TA=25°C)

符号 Symbol	项目 Item	单位 Units	发光颜色 Device	最小值 Min	规格值 Typ.	最大值 Max.	测试条件 Test Conditions
VF	正向电压 Forward Voltage	V	Orange	1.8	2.0	2.2	IF=5mA
IR	反向电流 Reverse Current	uA	-	-	-	2	VR=7V
$\Delta \lambda 1/2$	发光角度 Viewing Angle	°	-	-	120	-	IF=5mA
C	电容 Capacitance	PF	Orange	-	105	-	VF=0V f=1MHz
Iv	发光强度 Luminous Intensity	Mcd	Orange	30	50	70	IF=5mA
$\lambda D$	主波长 Dominate Wavelength	Nm	Orange	600	603	606	IF=5mA



### 3. 特性曲线 Characteristic curve

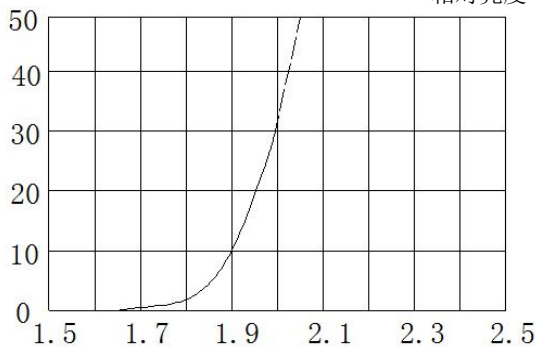
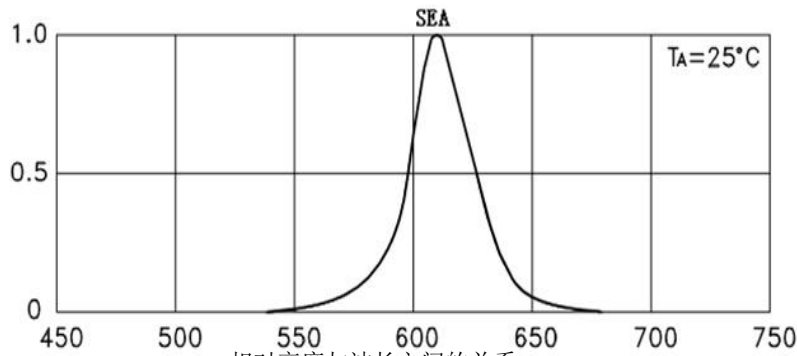

正向电流与正向电压关系曲线图

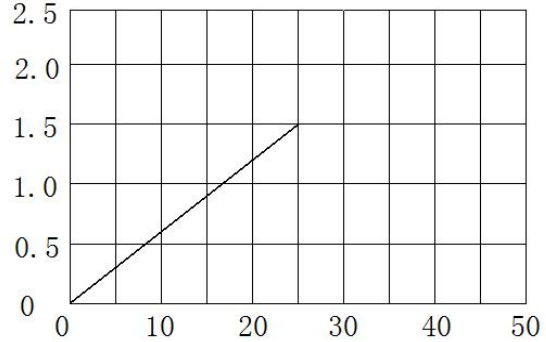

亮度与正向电流关系曲线图

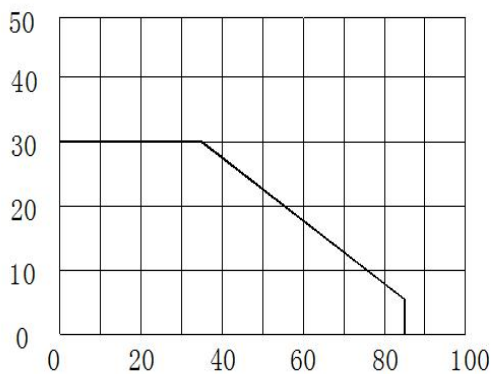

正向电流递减曲线图

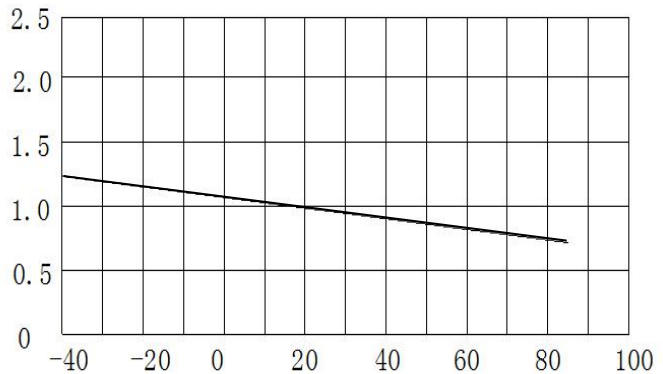

亮度与环境温度关系曲线图

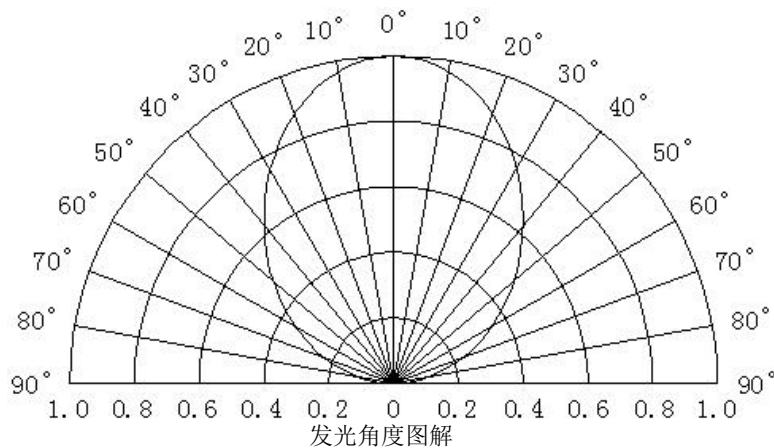



### 4. 可靠性 RELIABILITY

#### (1) 测试项目及结果 Test Items and Results

序号	试验项目	参考标准	试验条件	持续时间	取样数	不良数量/ 抽样
1	温度循环	JEITA ED-4701	-40℃~25℃~ 100℃~ 25℃ 30 分钟 5 分钟 30 分钟 5 分钟	循环 100 回合	50	0/50
2	冷热冲击	MIL-STD-202G	-40℃~100℃ 15 分钟 15 分钟	循环 500 回合	50	0/50
3	高温储存	JEITA ED-4701 200 201	Ta=100℃	1000 小 时	50	0/50
4	低温储存	JEITA ED-4701 200 201	Ta=-40℃	1000 小 时	50	0/50
5	常温寿命 试验		Ta=25±5℃ IF=20mA	1000 小 时	50	0/50
6	高温高湿 寿命试验		Ta=60℃ RH=85% IF=20mA	1000 小 时	50	0/50
7	可焊性 (回流焊)	JEITA ED-4701 300 303	Tsol=235℃±5℃, 5 秒 使用助焊剂	焊接一 次, 5 秒	10	0/10
8	耐焊性 (回流焊)	JEITA ED-4701 300 301	Tsol=250℃, 10 秒 预处理: 35℃ 95%RH 96 小时	焊接二 次, 每次 10 秒	10	0/10

以上试验项目如与客户试验要求存在差异的或者特殊客户特殊要求的可根据实际情况按照客户的要求进行试作, 客户未要求的按我司试验标准试作. 不同产品使用不同电流进行测试

The above test items such as differences or special customer specific requirements according to the actual situation in accordance with the requirements of customers to try the requirements with the customer, the customer is not required by our test standard test. Different products using different current test



### 5. 注意事项 Cautions

#### (1) 焊接条件 Soldering Conditions

本产品最多只可回焊两次, 且在首次回焊后须冷却至室温之后方可进行第二次回焊.

Number of reflow process shall be less than 2 times and cooling process to normal temperature is required between first and Second soldering process.

推荐焊接条件(Recommended soldering conditions)

回流焊接Reflow soldering			手工焊接Hand welding	
	有铅 Lead Solder	无铅 Lead-free Solder	温度Temperature	350° C Max.
预热温度Pre-heat	140 ~ 160° C	180 ~ 200° C	焊接时间	3 sec. Max.
预热时间Pre-heat time	120 sec. Max.	120 sec. Max.	Soldering time	(onetime only)
峰值温度Peak temperature	230° C Max.	260° C Max.		
焊接时间Soldering time	10 sec. Max.	10 sec. Max.		
条件Condition	参考下图	参考下图		

有铅回焊 (Lead Solder)

无铅回焊 (Lead-Free Solder)

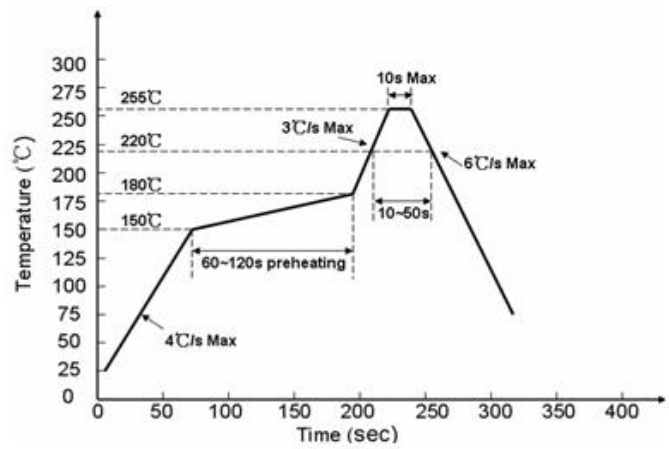
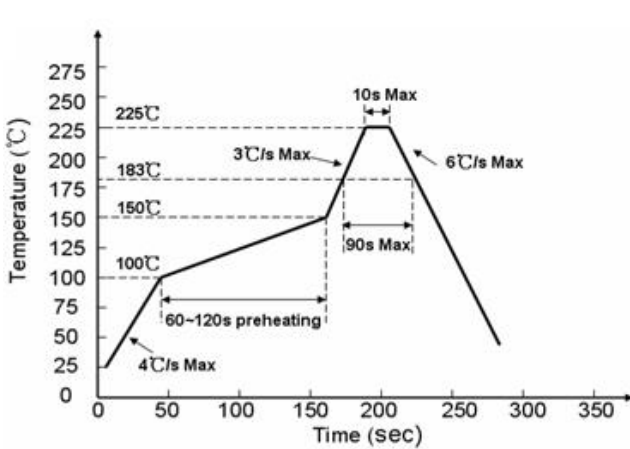

推荐焊盘式样(Recommended Soldering Pattern) 单位:毫米 (Units:mm)

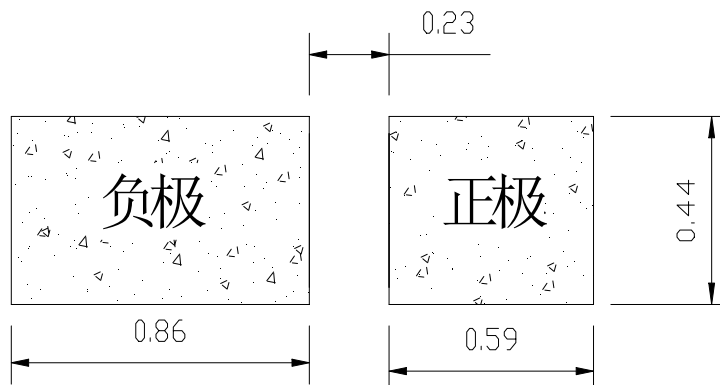



# 东莞市亿晶源光电科技有限公司

Dongguan Ekinglux Optoelectronics Technology Co.ltd

## (2) 静电 Static Electricity

触摸 LED 时, 推荐使用防静电手腕带或防静电手套.

It is recommended that a wrist band or an anti-electrostatic glove be used when handling the LEDs.

所有装置、设备、机器均应接地.

All devices, equipment and machinery must be properly grounded.

静电损坏的 LED 会显示出异常特征: 正向电压变低或在低电流时死灯. 标准:  $IF=0.5mA$  时,  $VF > 2.0V$

Damaged LEDs will show some unusual characteristics such as the forward voltage becomes lower, or the LEDs do not light at the low current. Criteria : ( $VF > 2.0V$  at  $IF=0.5mA$ )

## (3) 防潮包装 Moisture Proof Package

使用防潮包装

It is recommended that moisture proof package be used .

## (4) 储藏 Storage

打开包装袋之前, LED 在温度为  $30^{\circ}C$  或更低湿度 70%RH 以下, 可保存一年.

Before opening the package ,The LEDs should be kept at  $30^{\circ}C$  or less and 70%RH or less.

The LEDs should be used within a year.

## (5) 打开包装之后, 应在 24hrs 内焊接完毕.

After opening the package, The LEDs should be soldered within 24 hours (1days) after opening the package. If unused LEDs remain, they should be stored in moisture proof packages, such as sealed containers with packages of moisture absorbent material (silica gel).

下列情况发生时, 须要在焊接前重新烘烤  $60 \pm 5^{\circ}C$ , 12 小时以上.

A. 当包装袋破损漏气

B. 打开包装后在 24hrs 内未焊接完毕

C. LED 超过存储时间. .

If the moisture absorbent material (silica gel) has faded away or the LEDs have exceeded the storage time, baking treatment should be performed using the following conditions Baking treatment : more than 12 hours at  $60 \pm 5^{\circ}C$ .

## (6) 包装标签如下:

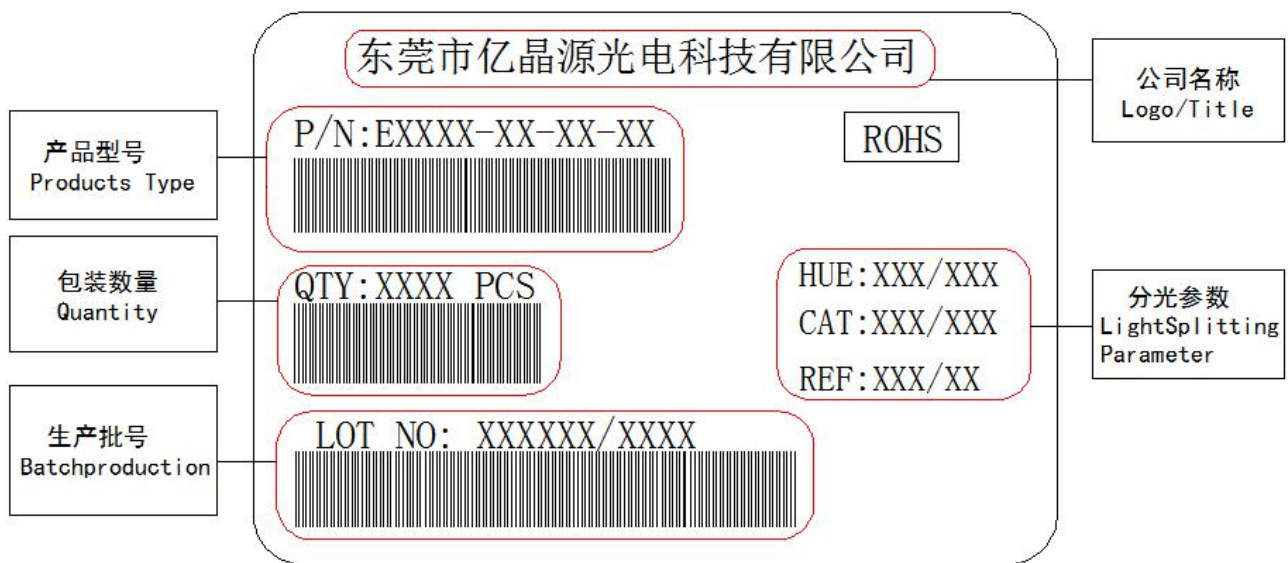

东莞市谢岗镇花园大道花园工业区 59 号

电话 0769-82856958

82856968

传真 0769-82856998

www.ekinglux.com



### 6. 包装 PACKAGING

- (1) LEDS 在装带之后纸箱包装. The LEDs are packed in cardboard boxes after taping.
- (2) 装带规格.Taping Specifications (单位:毫米 Units:mm)
- (3) 包装方式.Manner of packing

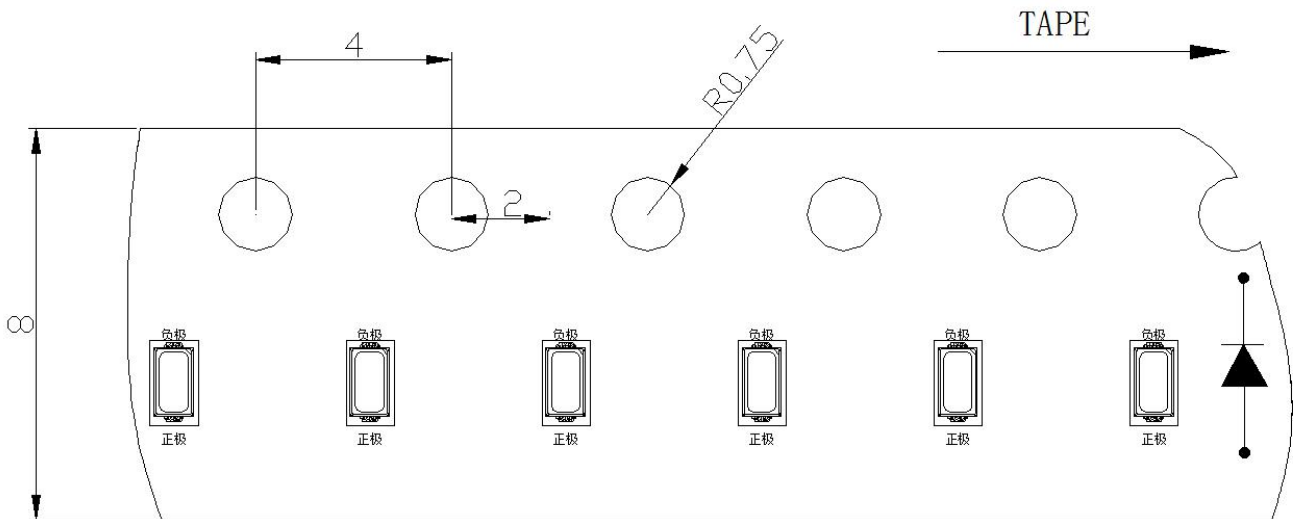

### (4) 卷轴尺寸

Reel Dimensions

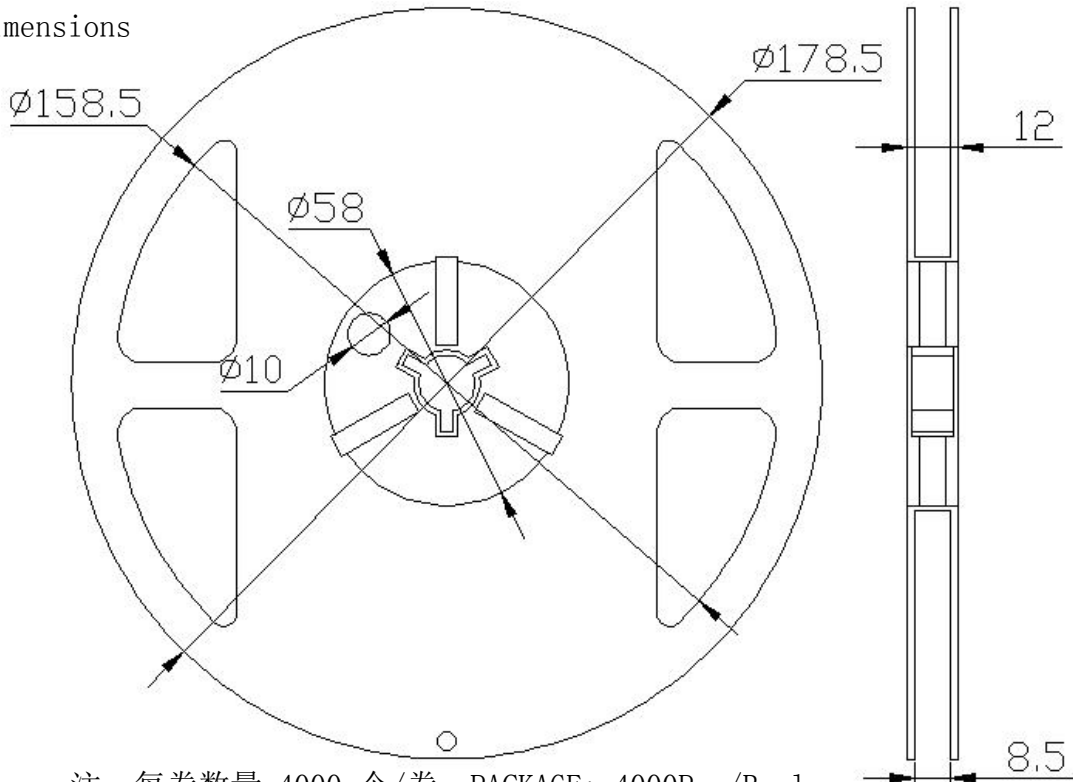

注: 每卷数量 4000 个/卷 PACKAGE: 4000Pcs/Reel





(5) 最小包装标签注明以下:产品名称.批号.光电范围.数量.

The label on the minimum packing unit shows ; Part Number, Lot Number, Ranking, Quantity.

(6) 请注意防水防潮

Keep away from water, moisture in order to protect the LEDs.

(7) 须采取适当防护措施,以防包装箱跌落或受到强力撞击造成对产品的损伤.

The LEDs may be damaged if the boxes are dropped or receive a strong impact against them. so precautions must be taken to prevent any damage.

### 7. 防潮包装袋

#### Moisture Resistant Packaging

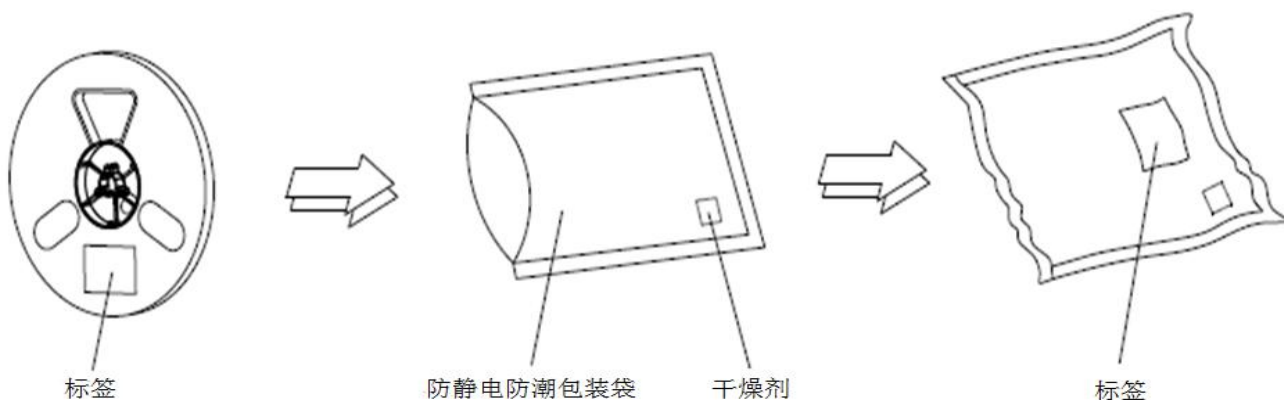

注:标注公差为 $\pm 0.1\text{MM}$ ,单位:MM

Note:The tolerances unless mentioned is  $\pm 0.1\text{mm}$ ,Unit:mm

表面贴装LED采用卷盘包装,LED在用普通或防静电袋包装后再装在纸箱中.纸箱用于保护运输途中LED不受机械冲击,纸箱不防水,因此请注意防潮防水

Surface mount LED is packed in reels, LED is packed in plain or antistatic bags and then packed in cartons. Cartons are used to protect the LED from mechanical shocks during shipping. Cartons are not waterproof, so please be waterproof