



The Innovative Switch Company

A The SRL1845 combines economical key lock switching with the versatility and dependability of Cole's 1800 Series spring return switch.

It has been engineered with the highest quality materials and meets or surpasses the most stringent requirements of MIL-DTL-3786.

The SRL 1845 key lock switch is excellent for the demanding usage of critical applications, such as medical and industrial control and instrumentation, as well as ground support electronic equipment.



SRL 1845 SERIES Spring-Return Key Lock Half-Inch Enclosed Rotary Switches

SRL 1845 SERIES

Spring-Return Key Lock Half-Inch Enclosed Rotary Switches

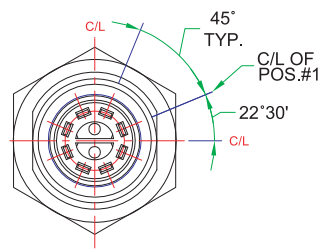
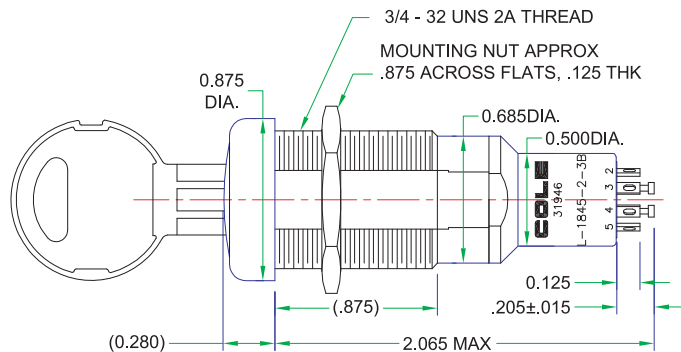

SUGGESTED MOUNTING HOLE FOR ALL SRL-1845 SWITCHES

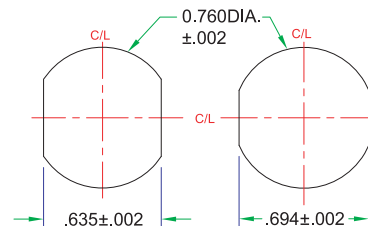

SWITCH ACTION AND KEY PULL POSITIONS

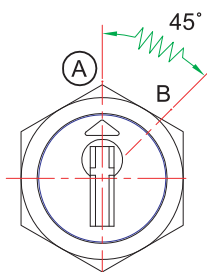

OPTION 1
Pos. "A" - Maintaining
Pos. "B" - Momentary

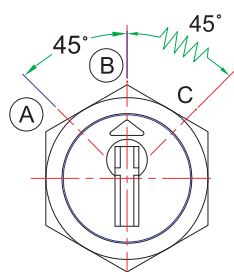

OPTION 2
Pos. "A" & "B" - Maintaining
Pos. "C" - Momentary

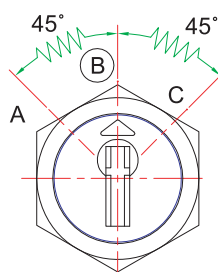

OPTION 3
Pos. "B" - Maintaining
Pos. "A" & "C" - Momentary

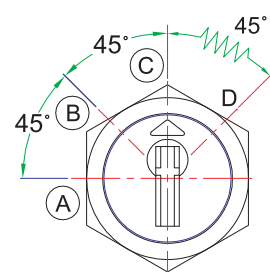

OPTION 4
Pos. "A", "B" & "C" - Maintaining
Pos. "D" - Momentary

(A) - Indicates Position With Key Pull Option

ORDERING INFORMATION

Sample code

SRL-1845 - 2 - 4 AB

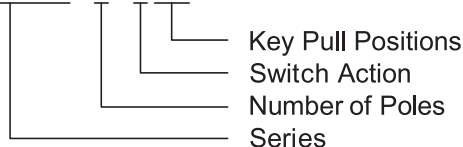

Switch shown in the sample code is 1800 Series Switch, Spring Return Industrial Key Lock, 45° Indexing, 2 pole, non-shorting switch, switch action Option 4, with key removals at A, B positions.

NOTES:

- 1) Switches are 45° indexing, 1 or 2 Poles, 2, 3, or 4 Positions Per Pole.
- 2) The switches are in position #1 when the key is in position "A"
- 3) When ordering specify SRL as a preface to the COLE basic switch number.
- 4) All keylock switches are keyed alike unless otherwise specified.
- 5) Keylock switches are supplied with full circle of terminals regardless of the number of active positions.