

**MODEL: 6N2-2A-5**

**NO.:301020003-00006**

Unit:mm Terminal type:

(+) 150mmCB104 (-)150mmLA106

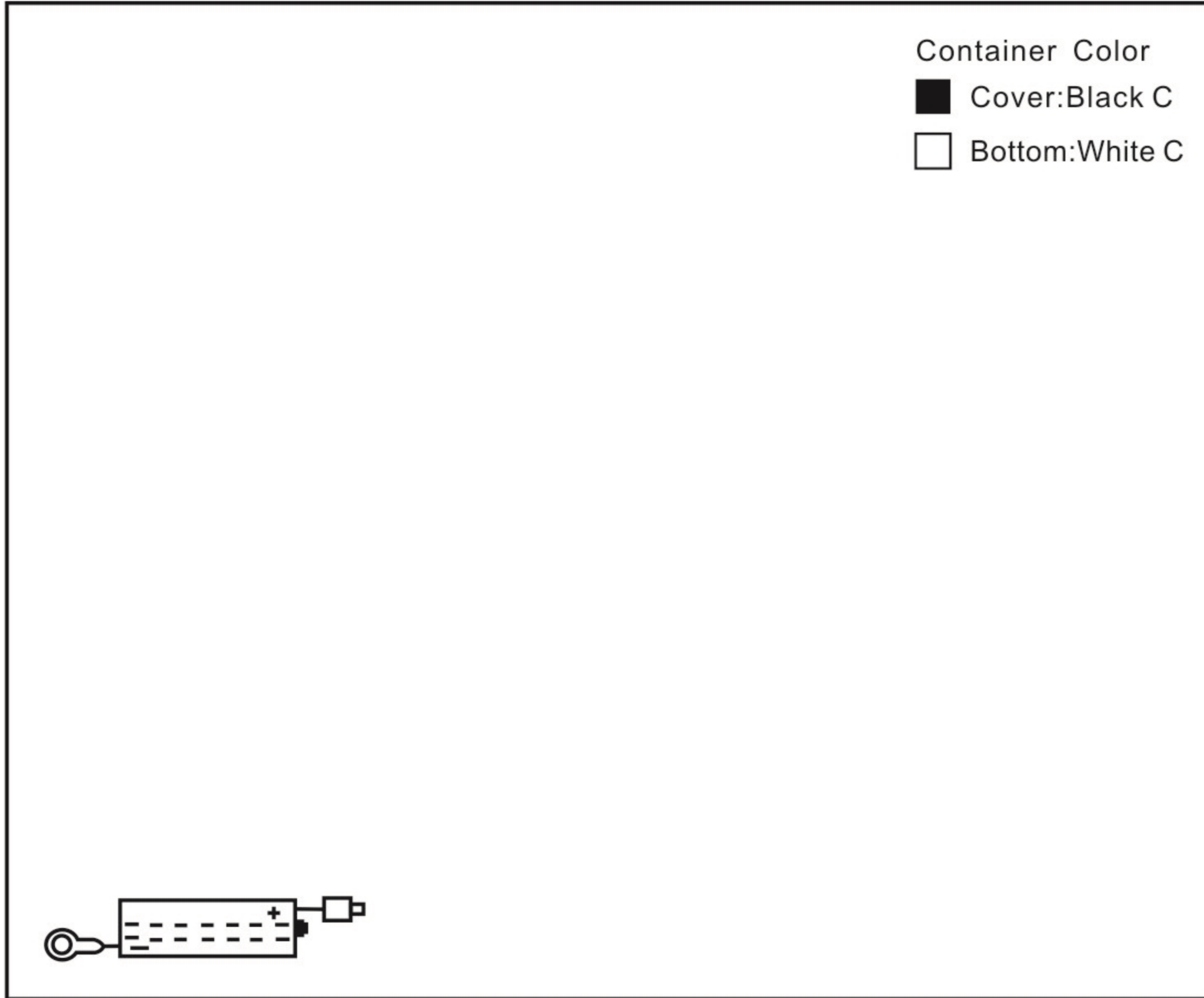

**Plane Chart:**

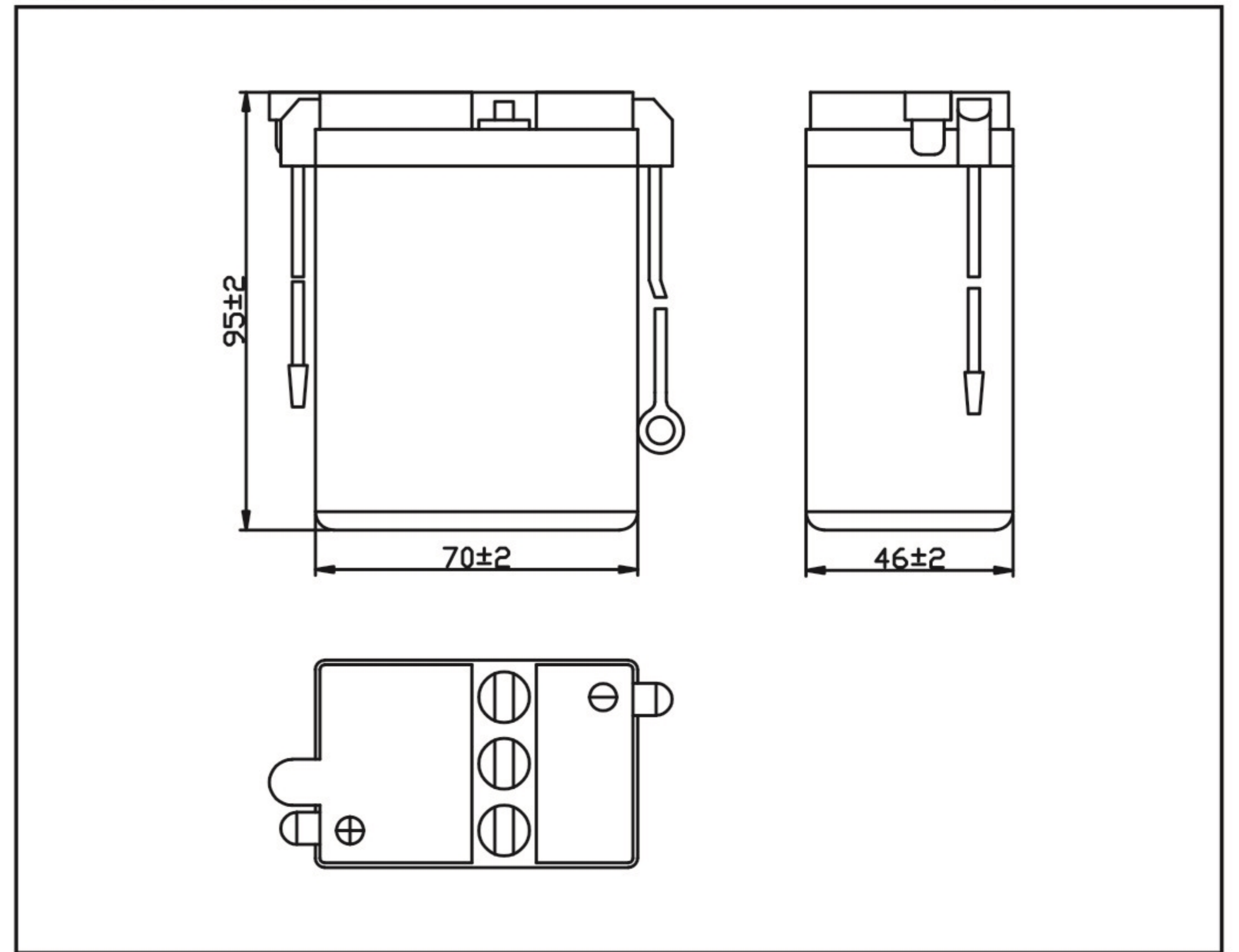

**Parts:**

Executed Standard:JISD 5302-2004

Cover	Container Bottom	Terminal	Positive Plate	Negative Plate	Separator	Electrolyte	Safety Valve	Explosion Plate	Way of Sealing
PP	PP	Pb	PbO <sub>2</sub>	Pb	PE/Compound Fibre	dilute sulphuric acid	Rubber	PP	Heat Sealing

**Parameter Chart:**

Volts	6V		
Capacity (25°C)	10 hours rate		2Ah
Appx.Dimension (mm)	L±2		70
	W±2		46
	H±2		95
Storage Status	Dry		
Weight (Approx)	0.37Kg	Weight w/ Acid	0.26Kg
	<b>Retention of Charge Storage @25°C</b>		
1 month	97%	Directly Mounted	
3 month	90%	Directly Mounted	
6 month	80%	Constant Volts:7.2V Limit Current:0.4A Charging Hours:2-3H	
12 month	40%	Constant Volts:7.2V Limit Current:0.4A Charging Hours:4-6H	
<b>CCA</b>	<b>Factory Standard (-10°C)</b>	<b>Factory Standard (-18°C)</b>	
Discharging Current	-	-	

**Discharge Current 25°C**

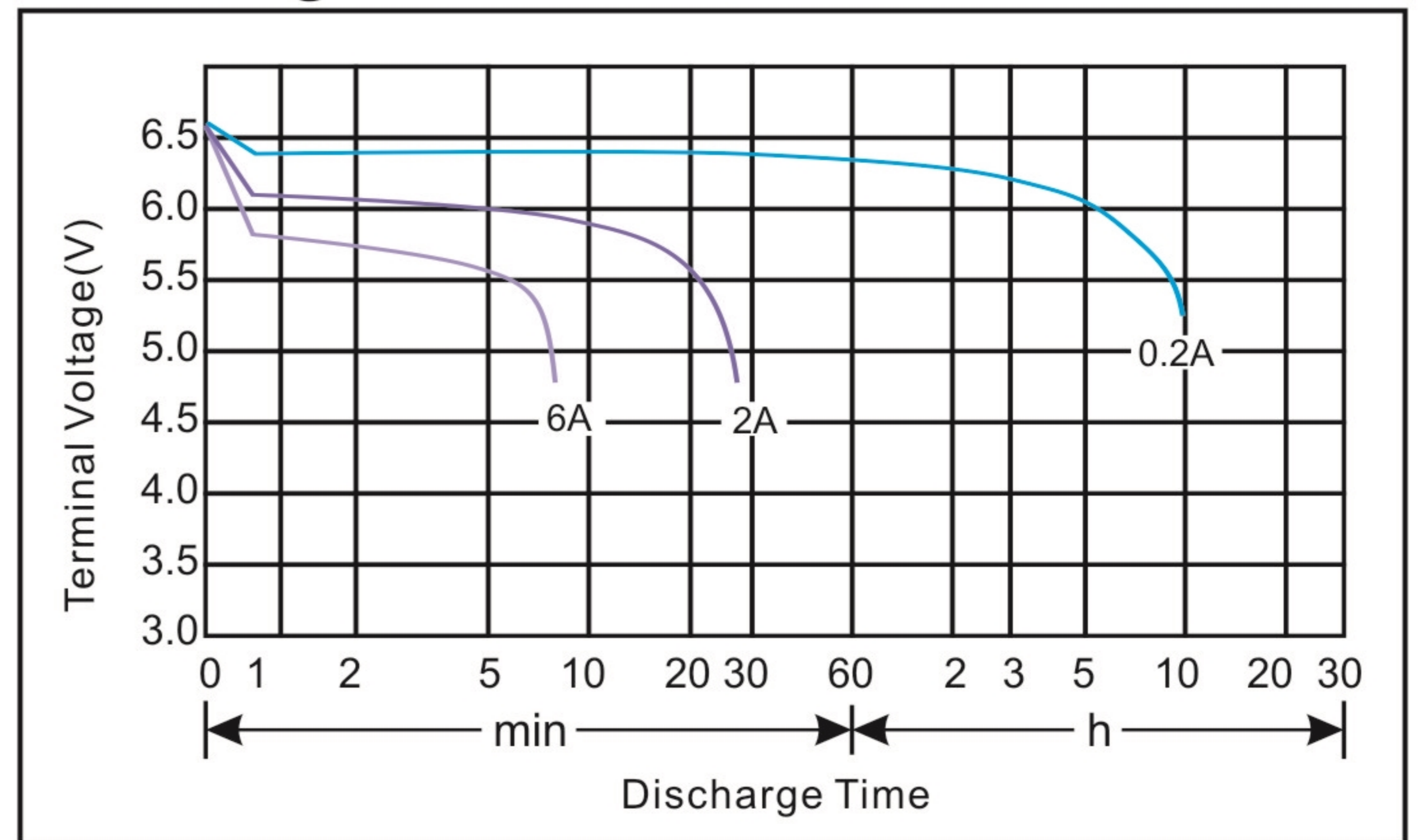

**Residual Capacity**

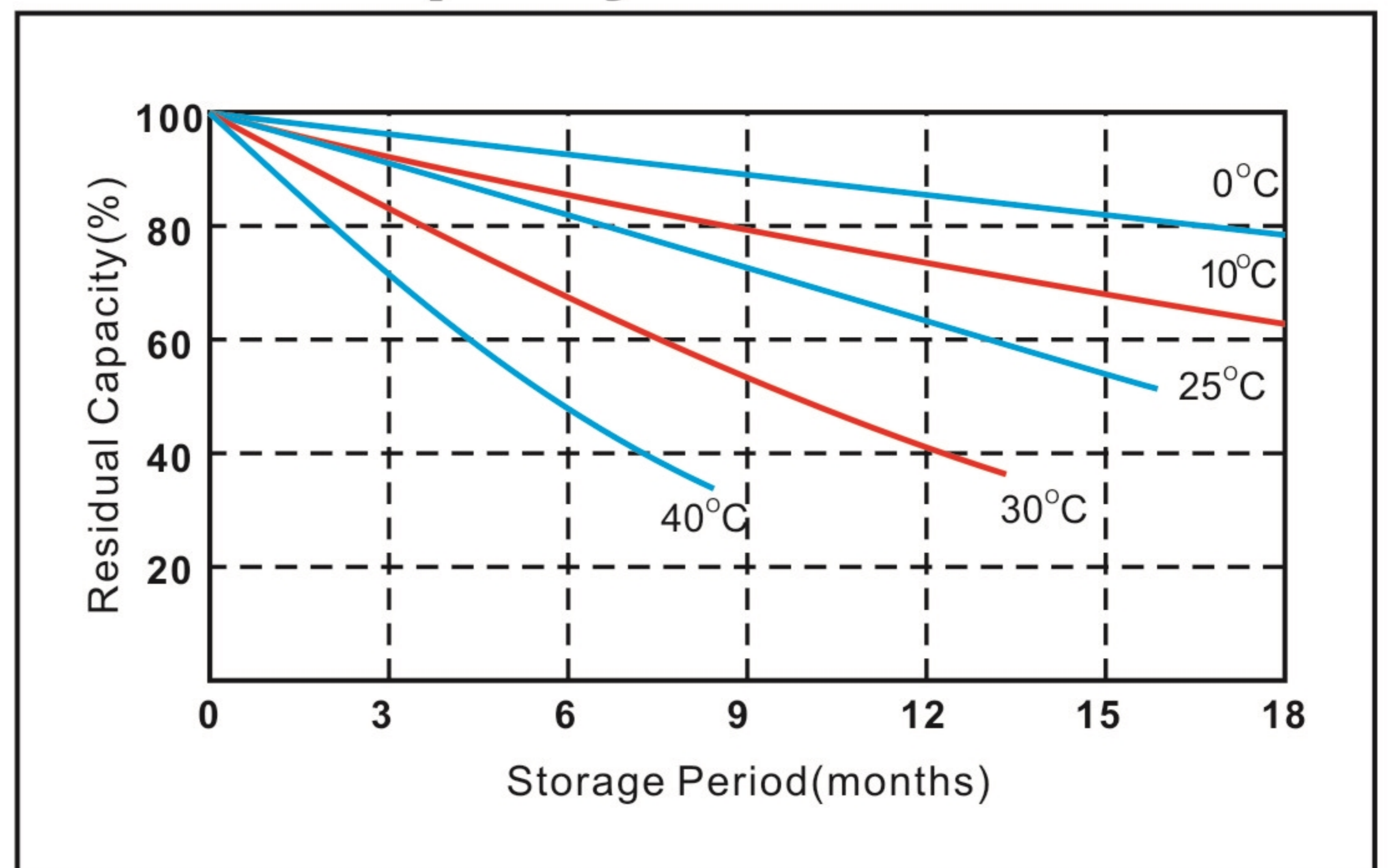

★The above are average and data obtained from the first 3 charge/discharge cycles. These are not minimum values.

★The different item No. of battery can be developed according to the customer's demand.