

Description

The CMN6009F5 is the N-Channel enhancement mode power field effect transistors with high cell density, trench technology. This high density process and design have been optimized switching performance and especially tailored to minimize on-state resistance.

Features

- V_{DS} : 60V
- I_D : 41.5A
- $R_{DS(on)}$ (@ $V_{GS}=10V$): < 11m Ω
- $R_{DS(on)}$ (@ $V_{GS}=4.5V$): < 15m Ω
- High density cell design for extremely low $R_{DS(on)}$
- Excellent on-resistance and DC current capability

Equivalent Circuit and Pin Configuration

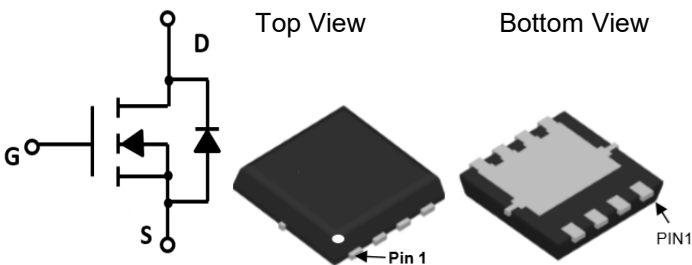

Applications

- Battery management
- Power management
- Load switch

Marking Information

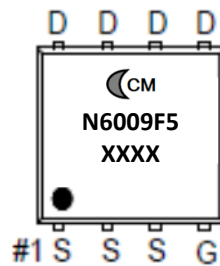

Marking Code = CMN6009F5

Date Code = XXXX

Ordering Information

Part Number	Packaging	Reel Size
CMN6009F5	5000/Tape & Reel	13 inch

Absolute Maximum Ratings (TA=25 °C unless otherwise noted)

Parameter	Symbol	Maximum	Unit	
Drain-source Voltage	V_{DS}	60	V	
Gate-source Voltage	V_{GS}	± 20	V	
Drain Current ⁽¹⁾⁽⁶⁾	I_D	TC=25°C	41.5	A
		TC=100°C	26.2	A
	I_D	TA=25°C	9.4	A
		TA=100°C	6	A
Pulsed Drain Current ⁽³⁾	I_{DM}	166	A	
Total Power Dissipation ⁽⁴⁾	PD	TC=25°C	41.6	W
		TA=25°C	2.1	W
Thermal Resistance Junction-to-Ambient ⁽²⁾⁽⁵⁾	$R_{\theta JA}$	58	°C/W	
Thermal Resistance Junction-to-Case	$R_{\theta Jc}$	3	°C/W	
Junction and Storage Temperature Range	T_J, T_{STG}	-55 to +150	°C	

Electrical Characteristics (T_J=25 °C unless otherwise noted)

Parameter	Symbol	Conditions	Min	Typ	Max	Units
Static Parameter						
Drain-Source Breakdown Voltage	BVDSS	V _{GS} =0V, I _D =250μA	60			V
Zero Gate Voltage Drain Current	I _{DSS}	V _{DS} =60V, V _{GS} =0V, T _C =25°C			1	μA
Gate-Body Leakage Current	I _{GSS}	V _{GS} =±20V, V _{DS} =0V			±100	nA
Gate Threshold Voltage	V _{GS(th)}	V _{DS} =V _{GS} , I _D =250μA	1.0		3.0	V
Static Drain-Source on-Resistance	R _{DS(on)}	V _{GS} =10V, I _D =8A		9	11	mΩ
		V _{GS} =4.5V, I _D =4A		12	15	
Diode Forward Voltage	V _{SD}	I _S =20A, V _{GS} =0V			1.2	V
Maximum Body-Diode Continuous Current	I _S				41.5	A
Dynamic Parameters						
Input Capacitance	C _{iss}	V _{DS} =30V, V _{GS} =0V, f=1MHz		1020		pF
Output Capacitance	C _{oss}			330		
Reverse Transfer Capacitance	C _{rss}			4		
Switching Parameters						
Total Gate Charge	Q _g	V _{GS} =10V, V _{DS} =30V, I _D =8A		16		nC
Gate Source Charge	Q _{gs}			2.8		
Gate Drain Charge	Q _{gd}			2.9		
Turn-on Delay Time	t _{D(on)}	V _{GS} =10V, V _{DD} =30V, I _D =8A, R _{GEN} =3Ω		13.2		ns
Turn-on Rise Time	t _r			18		
Turn-off Delay Time	t _{D(off)}			40		
Turn-off Fall Time	t _f			9		

Noted: (1) Pulse Test: Pulse Width ≤ 300us, Duty cycle ≤ 2%.

- (2) The value of R_{θJA} is measured with the device mounted on lin2 FR-4 board with 2oz. Copper, in a still air environment with T_A = 25°C. The Power dissipation P_{DSM} is based on R_{θJA}, t ≤ 10s and the maximum allowed junction temperature of 150°C. The value in any given application depends on the user's specific board design.
- (3) Single pulse width limited by junction temperature T_{J(MAX)} = 150°C.
- (4) The power dissipation P_D is based on T_{J(MAX)} = 150°C, using junction-to-case thermal resistance, and is more useful in setting the upper Dissipation limit for cases where additional heatsinking is used.
- (5) The R_{θJA} is the sum of the thermal impedance from junction to case R_{θJA} and case to ambient.
- (6) The maximum current rating is package limited.

Typical Performance Characteristics

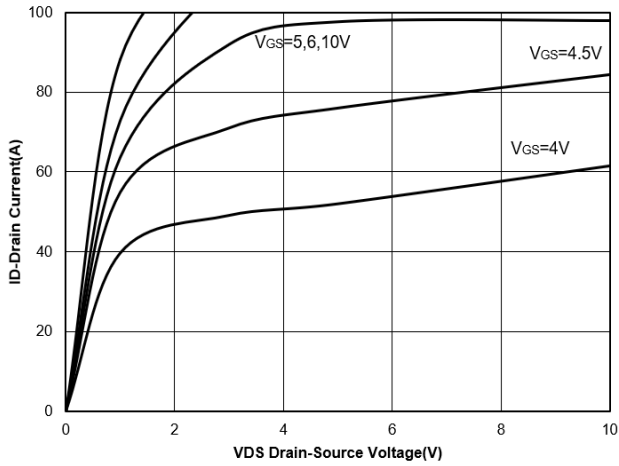

Figure 1. Output Characteristics

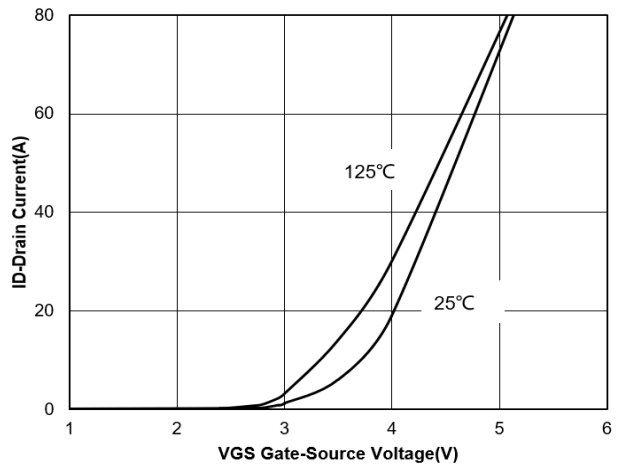

Figure 2. Transfer Characteristics

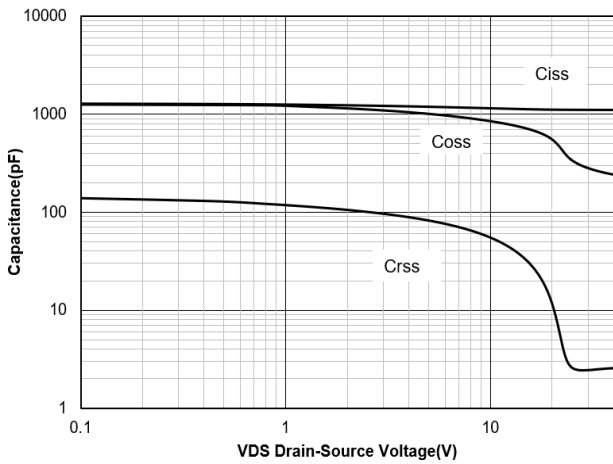

Figure 3. Capacitance Characteristics

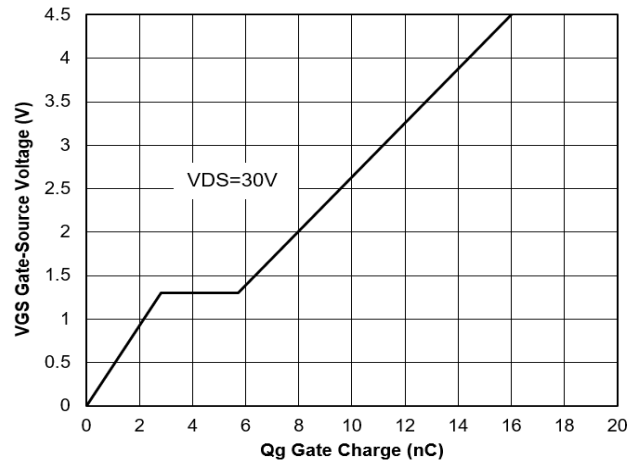

Figure 4. Gate Charge

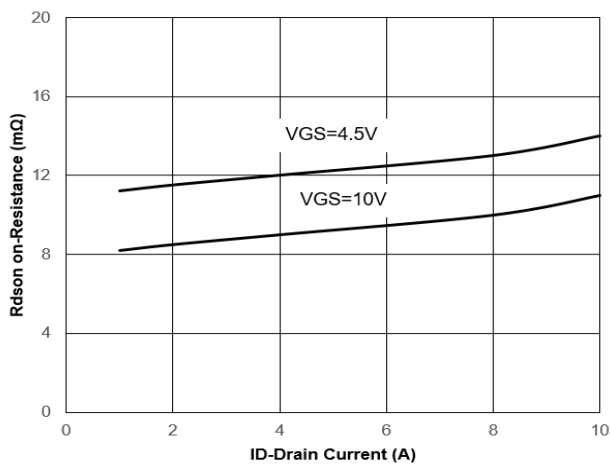

Figure 5. Drain-Source on Resistance

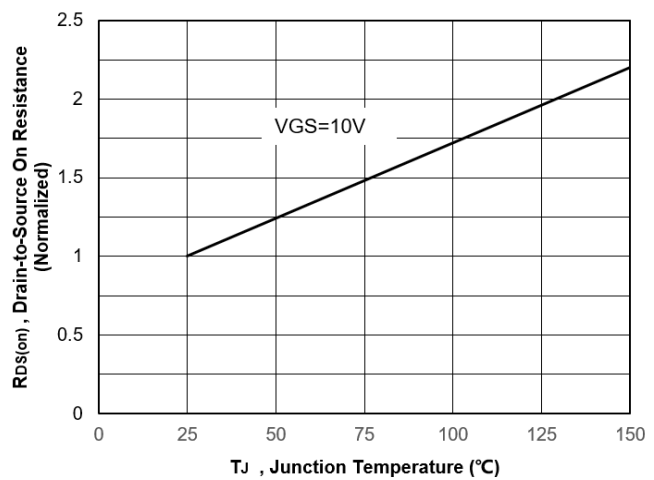

Figure 6. Normalized On-Resistance

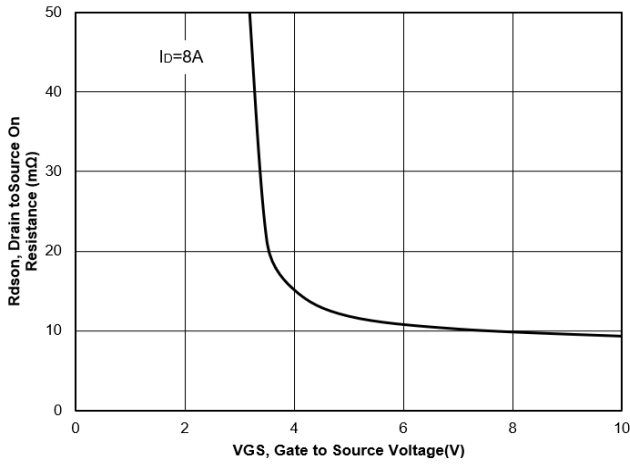

Figure 7. Typical Drain to Source ON Resistance VS Gate Voltage and Drain Current

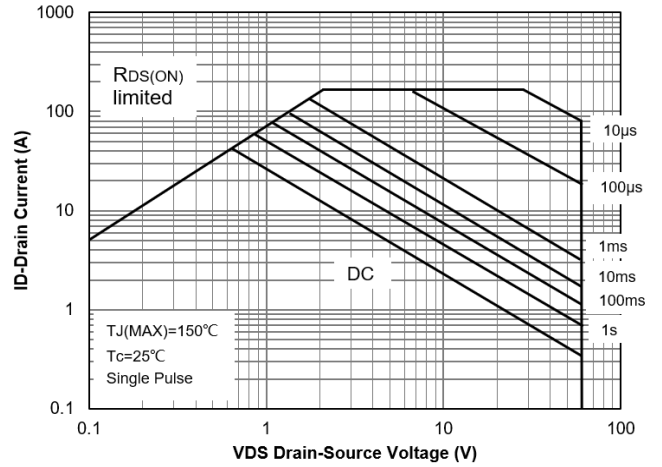

Figure 8. Safe Operation Area

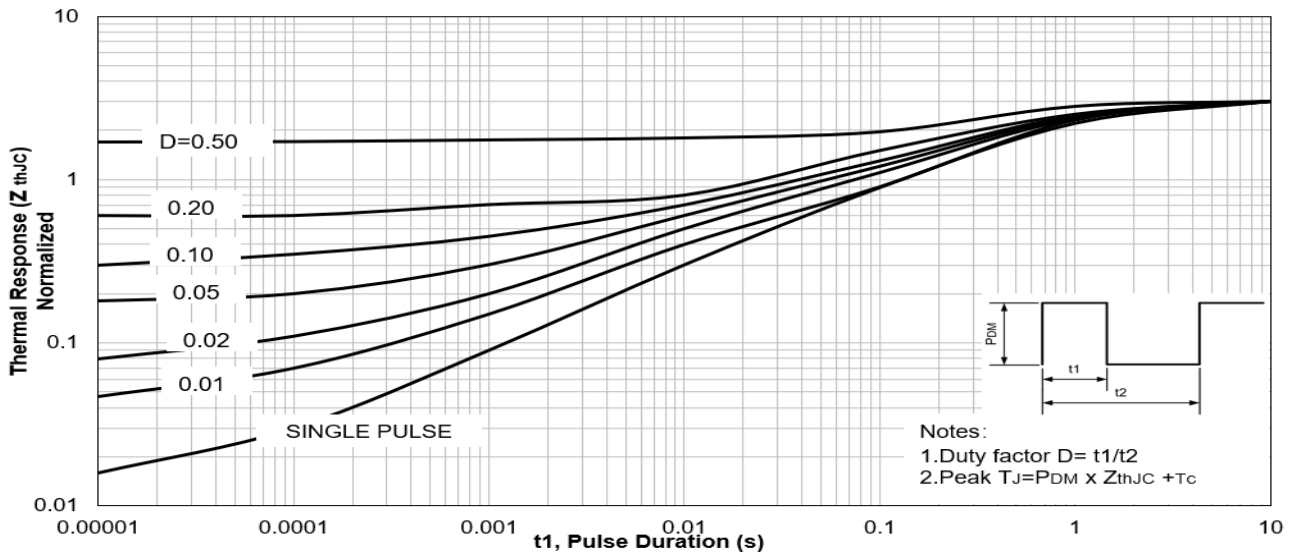

Figure 9. Maximum Effective Transient Thermal Impedance, Junction-to-Case

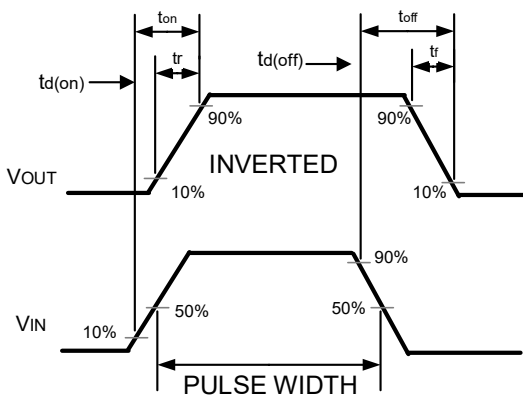
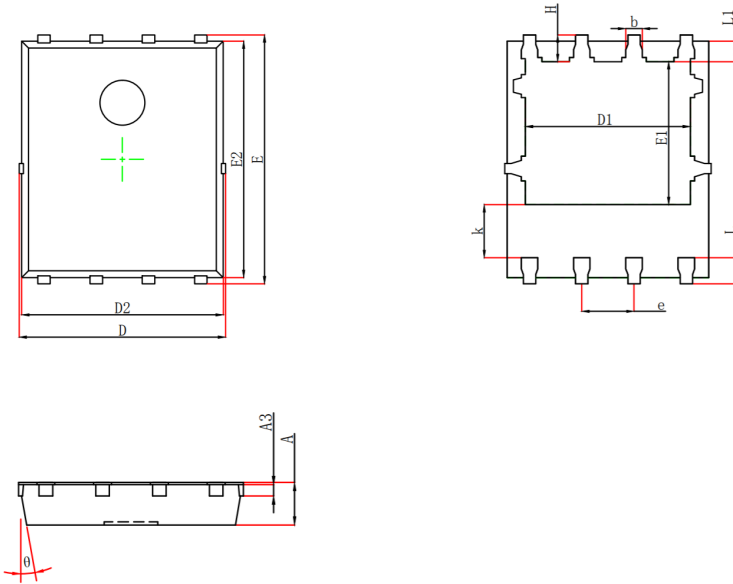

Figure 10. Switching wave

DFN 5X6 Package Outline Drawing



Symbol	Millimeters		Inches	
	Min.	Max.	Min.	Max.
A	0.900	1.000	0.035	0.039
A3	0.254 REF.		0.010 REF.	
D	4.944	5.096	0.195	0.201
E	5.974	6.126	0.235	0.241
D1	3.910	4.110	0.154	0.162
E1	3.375	3.575	0.133	0.141
D2	4.824	4.976	0.190	0.196
E2	5.674	5.826	0.223	0.229
k	1.190	1.390	0.047	0.055
b	0.350	0.450	0.014	0.018
e	1.270 TYP.		0.050 TYP.	
L	0.559	0.711	0.022	0.028
L1	0.424	0.576	0.017	0.023
H	0.574	0.726	0.023	0.029
θ	10°	12°	10°	12°

Contact Information

Applied Power Microelectronics Inc.

Website: <http://www.appliedpowermicro.com>

Email: sales@appliedpowermicro.com

Phone: +86 (0519) 8399 3606