

Description

The CMN1003GXP is the N-Channel enhancement mode power field effect transistors with high cell density, high voltage planar technology. This high density process and design have been optimized switching performance and especially tailored to minimize on-state resistance, .

Features

- VDS: 100V
- ID (@VGS=10V): 172A
- RDS_{ON} (@VGS=10V) : < 5mΩ
- High density cell design for extremely low RDS_{ON}
- Excellent on-resistance and DC current capability

Equivalent Circuit and Pin Configuration

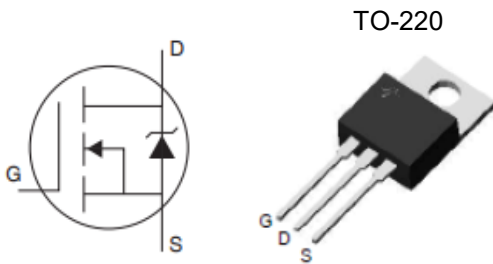

Applications

- AC/DC load switch
- SMPS
- LED power

Marking Information



CMN1003GXP=Marking Code
 XXXX = Date Code

Ordering Information

P/N	Package Type	Packaging	Remark
CMN1003XGP	TO-220	Tube	ROHS

Absolute Maximum Ratings (T_c=25 °C unless otherwise noted)

Parameter	Symbol	Maximum	Unit
Drain-source Voltage	V _{DS}	100	V
Gate-source Voltage	V _{GS}	±20	V
Continuous Drain Current ⁽¹⁾	T _c =25°C (Silicon Limit)	172	A
	T _c =25°C (Package Limit)	120	
	T _c =100°C (Silicon Limit)	120	
Pulsed Drain Current ⁽²⁾	I _{DM}	480	A
Total Power Dissipation ⁽³⁾	PD @ T _c =25°C	311	W
	Derating Factor above 25°C	2.5	W/°C
Thermal Resistance Junction-to-Case ⁽³⁾	R _{θJC}	0.402	°C/W
Junction and Storage Temperature Range	T _J ,T _{STG}	-55 to +150	°C

Electrical Characteristics (T_c=25 °C unless otherwise noted)

Parameter	Symbol	Conditions	Min	Typ	Max	Units
Static Parameter						
Drain-Source Breakdown Voltage	B _V D _{SS}	V _{GS} =0V, I _D =250μA	100			V
Zero Gate Voltage Drain Current	I _{DSS}	V _{DS} =100V, V _{GS} =0V, T _C =25°C			1	μA
Gate-Body Leakage Current	I _{GSS}	V _{GS} =±20V, V _{DS} =0V			±100	nA
Gate Threshold Voltage	V _{GS(th)}	V _{DS} =V _{GS} , I _D =250μA	2.0		4.0	V
Static Drain-Source on-Resistance	R _{DS(on)}	V _{GS} =10V, I _D =30A		3.8	5	mΩ
Diode Forward Voltage	V _{SD}	I _S =30A, V _{GS} =0V		0.8	1.2	V
Maximum Body-Diode Continuous Current	I _S				172	A
Dynamic Parameters						
Input Capacitance	C _{iss}	V _{DS} =50V, V _{GS} =0V, f=1MHz		9200		pF
Output Capacitance	C _{oss}			1180		
Reverse Transfer Capacitance	C _{rss}			28		
Switching Parameters						
Total Gate Charge	Q _g	V _{DS} =50V, I _D =20A, V _{GS} =10V		152		nC
Gate Source Charge	Q _{gs}			41		
Gate Drain Charge	Q _{gd}			42		
Turn-on Delay Time	t _{D(on)}	V _{GS} =10V, V _{DD} =50V, I _D =20A, R _{GEN} =2.2Ω		88		ns
Turn-on Rise Time	t _r			60.5		
Turn-off Delay Time	t _{D(off)}			136		
Turn-off Fall Time	t _f			56.2		

Noted: (1) Pulse Test: Pulse Width ≤ 300us, Duty cycle ≤ 2%

(2) Pulse width limited by maximum junction temperature

(3) Device mounted on FR-4 PCB, 1 inch x 0.85 inch x 0.062 inch. With 2oz Copper, t ≤ 10s

Typical Performance Characteristics

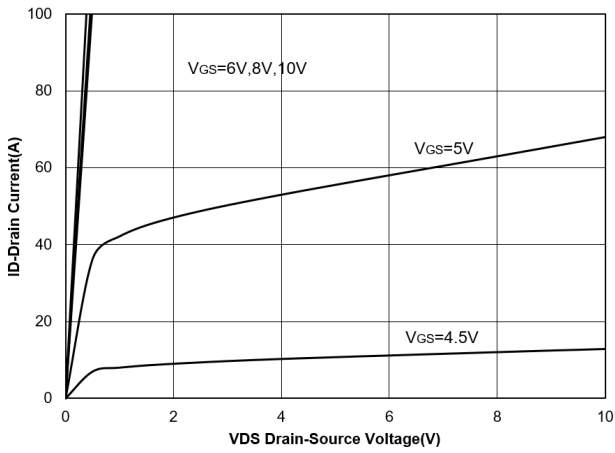

Figure 1. Output Characteristics

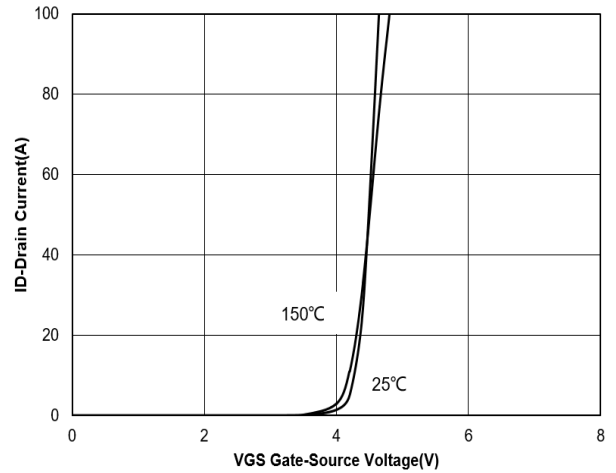

Figure 2. Transfer Characteristics

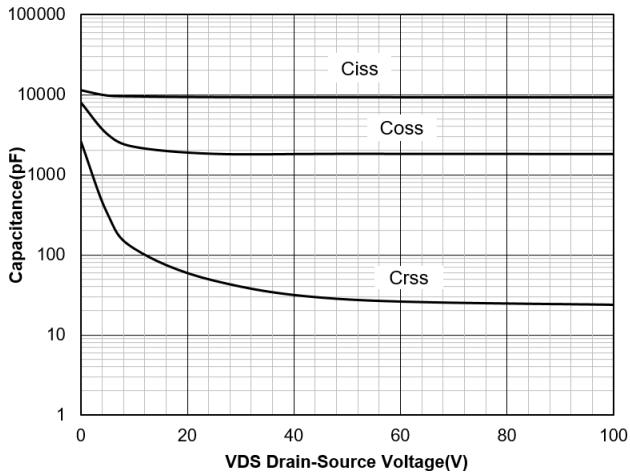

Figure 3. Capacitance Characteristics

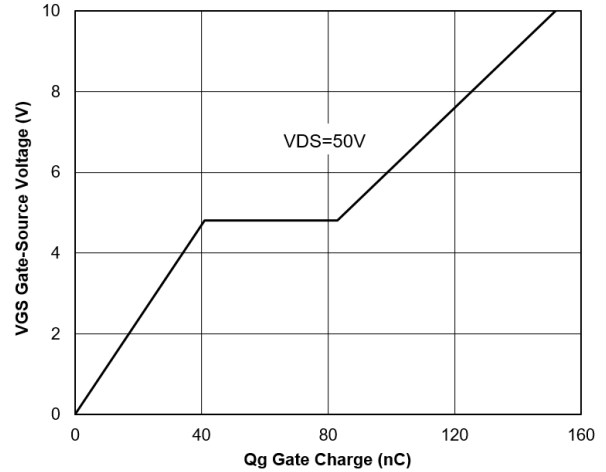

Figure 4. Gate Charge

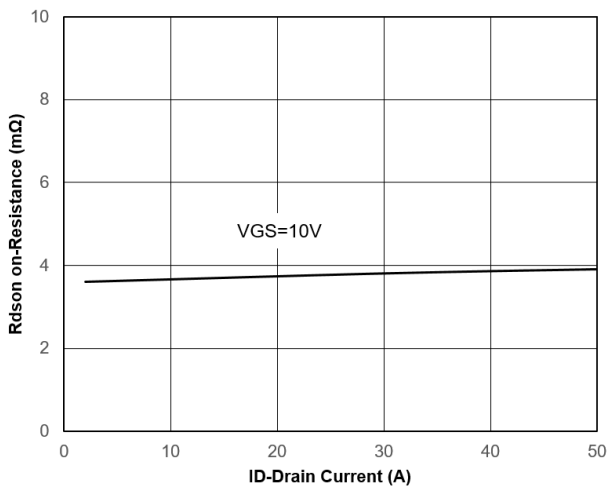

Figure 5. Drain-Source on Resistance

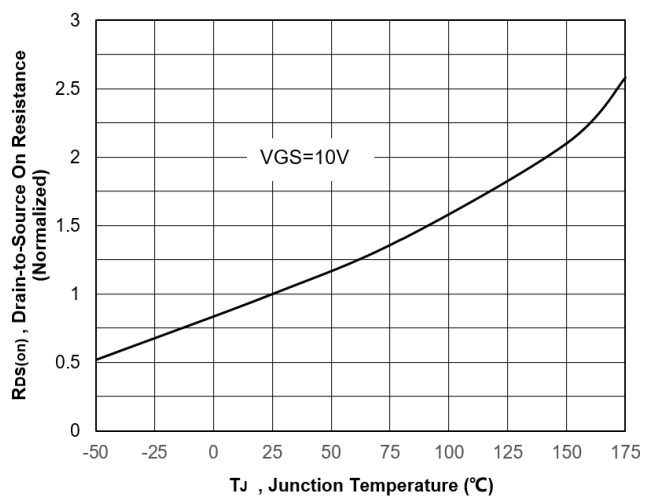

Figure 6. Normalized On-Resistance Vs. Temperature

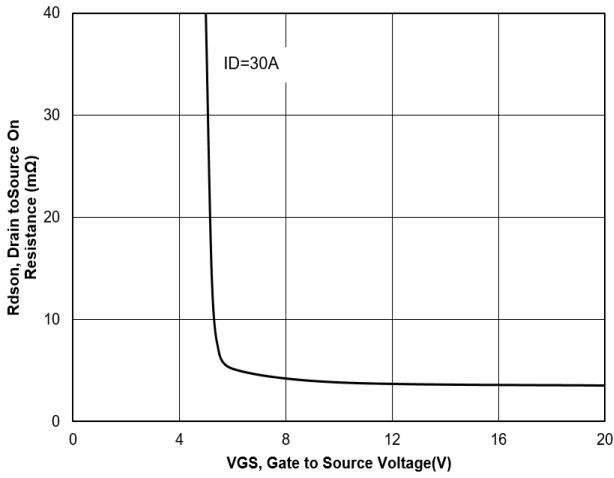

Figure 7. Typical Drain to Source ON Resistance VS Gate Voltage and Drain Current

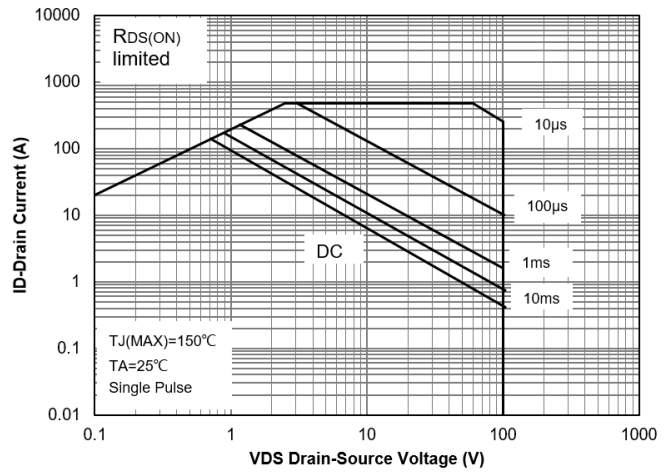

Figure 8. Safe Operation Area

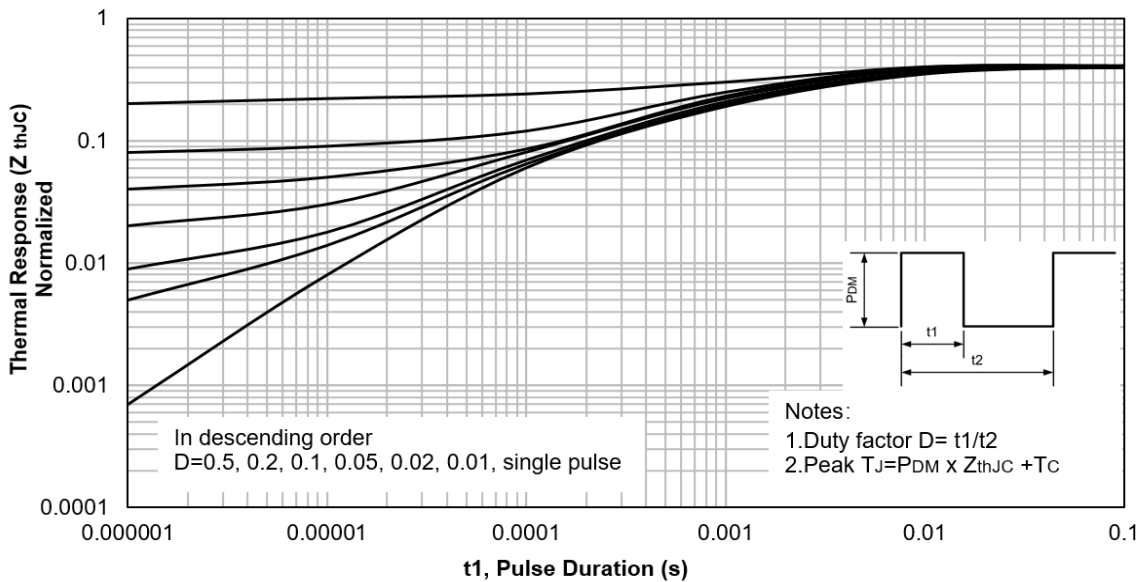

Figure 9. Maximum Effective Transient Thermal Impedance, Junction-to-Case

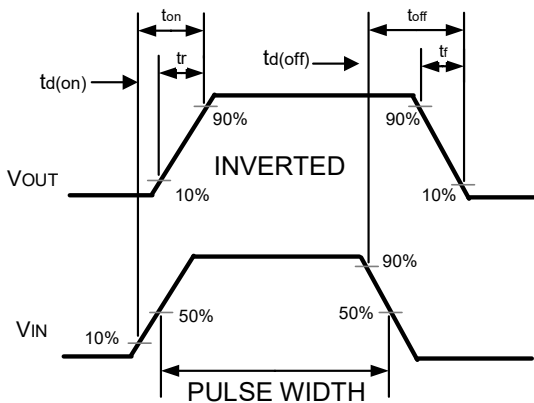
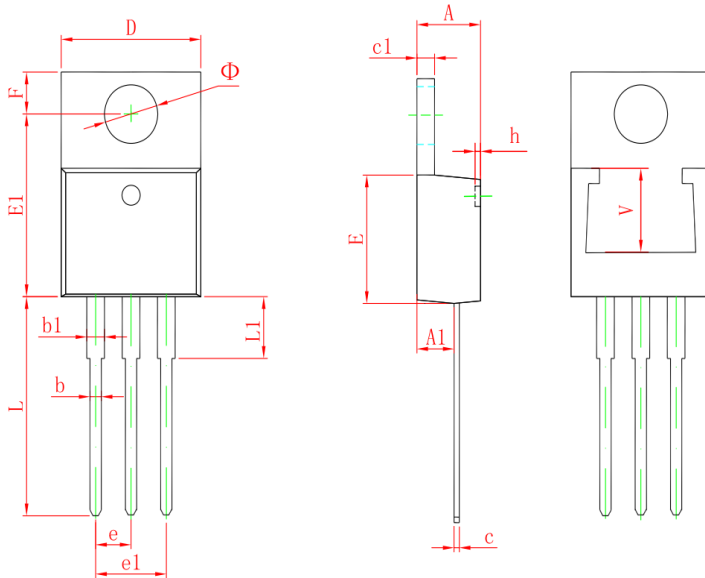

Figure 10. Switching wave

TO-220 Package Outline Drawing



Symbol	Millimeters		Inches	
	Min.	Max.	Min.	Max.
A	4.470	4.670	0.176	0.184
A1	2.520	2.820	0.099	0.111
b	0.710	0.910	0.028	0.036
b1	1.170	1.370	0.046	0.054
c	0.310	0.530	0.012	0.021
c1	1.170	1.370	0.046	0.054
D	10.010	10.310	0.394	0.406
E	8.500	8.900	0.335	0.350
E1	12.060	12.460	0.475	0.491
e	2.540 TYP.		0.100 TYP.	
e1	4.980	5.180	0.196	0.204
F	2.590	2.890	0.102	0.114
h	0.000	0.300	0.000	0.012
L	13.400	13.800	0.528	0.543
L1	3.560	3.960	0.140	0.156
Φ	3.735	3.935	0.147	0.155
V	5.600 REF.		0.220 REF.	

Contact Information

Applied Power Microelectronics Inc.

Website: <http://www.appliedpowermicro.com>

Email: sales@appliedpowermicro.com

Phone: +86 (0519) 8399 3606