

Description

The CM65R550P/F is the N-Channel enhancement mode power field effect transistors with high cell density, high voltage Super Junction technology. This high density process and design have been optimized switching performance and especially tailored to minimize on-state resistance, .

Features

- VDS: 650V
- ID (@VGS=10V): 8A
- RDS_{ON} (@VGS=10V) : < 555mΩ
- High density cell design for extremely low RDS_{ON}
- Excellent on-resistance and DC current capability

Equivalent Circuit and Pin Configuration

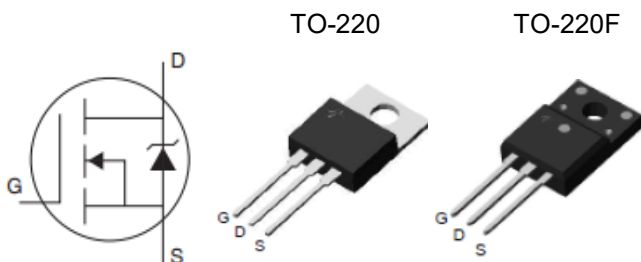

Applications

- AC/DC load switch
- SMPS
- LED power

Marking Information

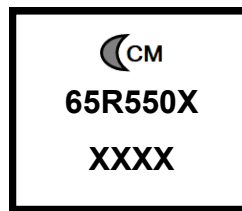

X=Package type
 XXXX = Marking Code

Ordering Information

P/N	Package Type	Packaging
CM65R550P	TO-220	Tube
CM65R550F	TO-220F	Tube

Absolute Maximum Ratings (Tc=25 °C unless otherwise noted)

Parameter	Symbol	Maximum		Unit	
		CM65R550P	CM65R550F		
Drain-source Voltage	VDS	650		V	
Gate-source Voltage	VGS	±30		V	
Continuous Drain Current ⁽¹⁾	ID	Tc=25°C	8	8 ⁽⁴⁾	A
		Tc=100°C	5	5 ⁽⁴⁾	A
Pulsed Drain Current ⁽²⁾	IDM	32	32 ⁽⁴⁾	A	
Total Power Dissipation ⁽³⁾	PD @ Tc=25°C	104	35	W	
	Derating Factor above 25°C	0.8	0.3	W/°C	
Thermal Resistance Junction-to-Case ⁽³⁾	RθJC	1.2	3.6	°C/W	
Junction and Storage Temperature Range	TJ,TSTG	-55 to +150		°C	

Electrical Characteristics (T_c=25 °C unless otherwise noted)

Parameter	Symbol	Conditions	Min	Typ	Max	Units
Static Parameter						
Drain-Source Breakdown Voltage	BVDSS	V _{GS} =0V, I _D =250μA	650			V
Zero Gate Voltage Drain Current	I _{DSS}	V _{DS} =650V, V _{GS} =0V, T _C =25°C			1	μA
Gate-Body Leakage Current	I _{GSS}	V _{GS} =±30V, V _{DS} =0V			±100	nA
Gate Threshold Voltage	V _{GS(th)}	V _{DS} =V _{GS} , I _D =250μA	2.0		4.0	V
Static Drain-Source on-Resistance	R _{DS(on)}	V _{GS} =10V, I _D =4A		460	555	mΩ
Diode Forward Voltage	V _{SD}	I _S =8A, V _{GS} =0V			1.4	V
Maximum Body-Diode Continuous Current	I _S				8	A
Dynamic Parameters						
Input Capacitance	C _{iss}	V _{DS} =100V, V _{GS} =0V, f=1MHz		510		pF
Output Capacitance	C _{oss}			26		
Reverse Transfer Capacitance	C _{rss}			2		
Switching Parameters						
Total Gate Charge	Q _g	V _{DS} =480V, I _D =4.0A, V _{GS} =10V		12		nC
Gate Source Charge	Q _{gs}			2.4		
Gate Drain Charge	Q _{gd}			4.3		
Turn-on Delay Time	t _{D(on)}	V _{GS} =10V, V _{DD} =60V, R _L =15Ω, I _D =4A, R _{GEN} =25Ω		36		ns
Turn-on Rise Time	t _r			18		
Turn-off Delay Time	t _{D(off)}			39		
Turn-off Fall Time	t _f			23		

Noted: (1) Pulse Test: Pulse Width ≤ 300us, Duty cycle ≤ 2%

(2) Pulse width limited by maximum junction temperature

(3) Device mounted on FR-4 PCB, 1 inch x 0.85 inch x 0.062 inch. With 2oz Copper, t ≤ 10s

(4) Drain current limited by maximum junction temperature

Typical Performance Characteristics

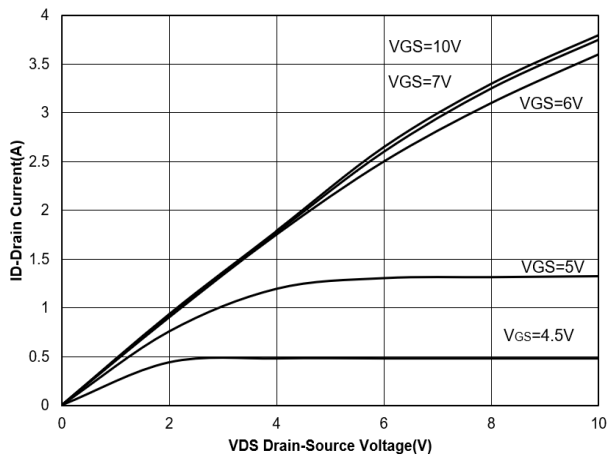

Figure 1. Output Characteristics

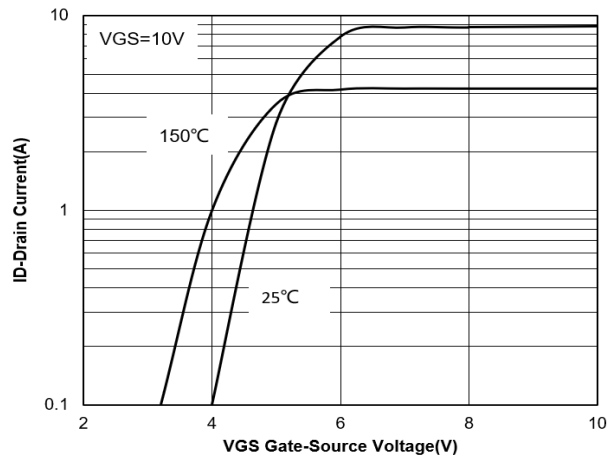

Figure 2. Transfer Characteristics

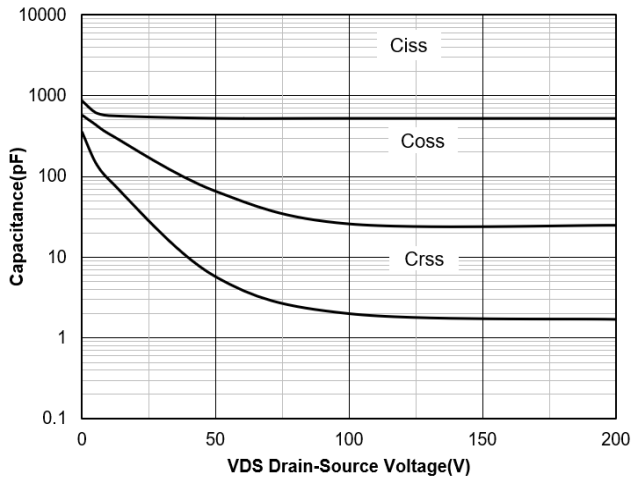

Figure 3. Capacitance Characteristics

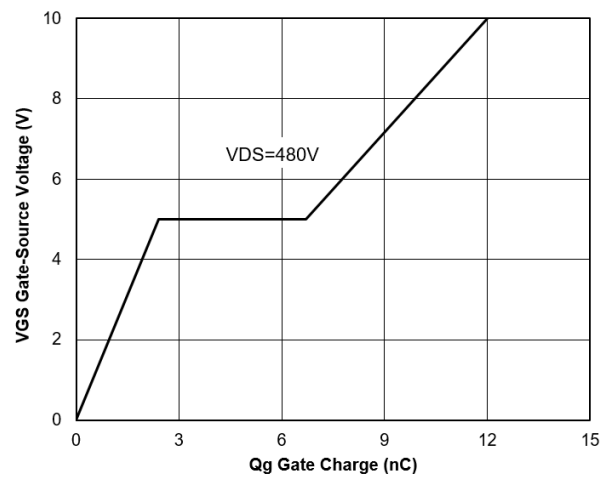

Figure 4. Gate Charge

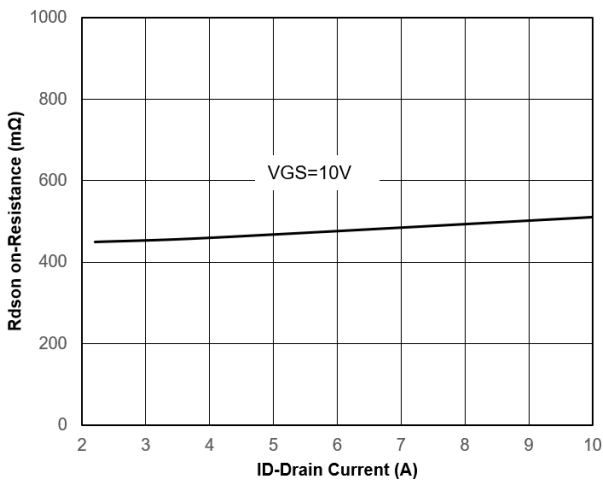

Figure 5. Drain-Source on Resistance

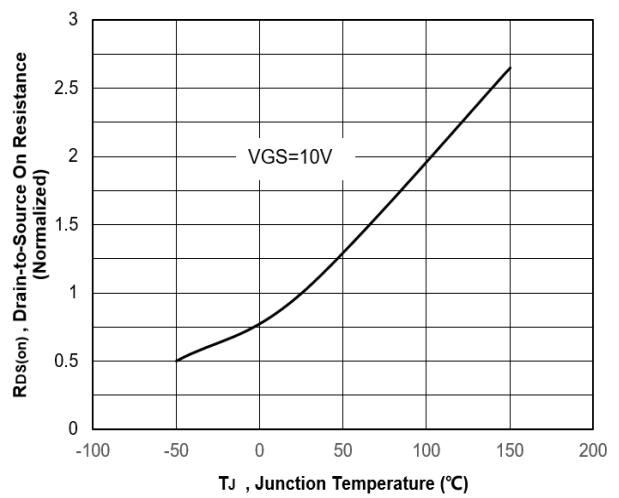

Figure 6. Normalized On-Resistance Vs. Temperature

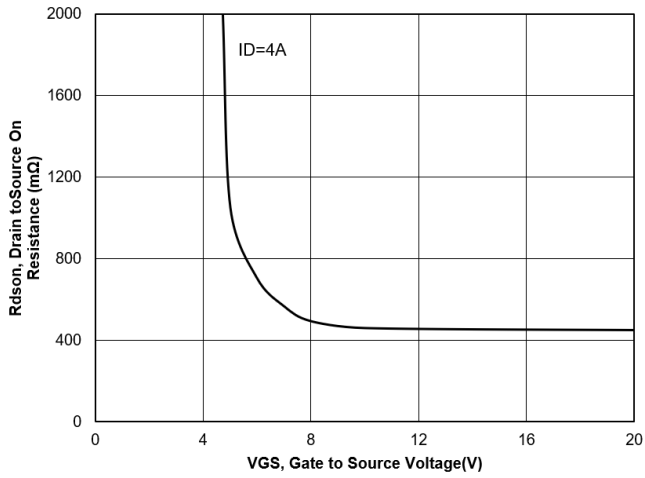

Figure 7. Typical Drain to Source ON Resistance VS Gate Voltage and Drain Current

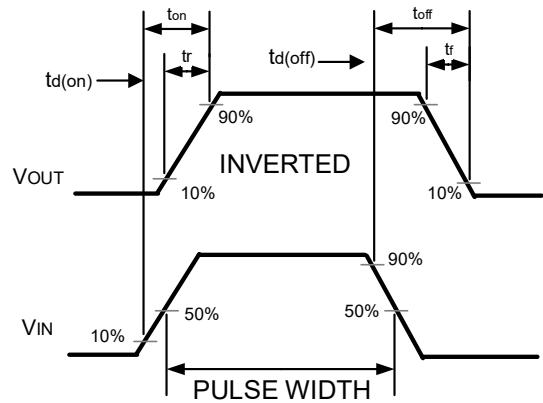

Figure 8. Switching wave

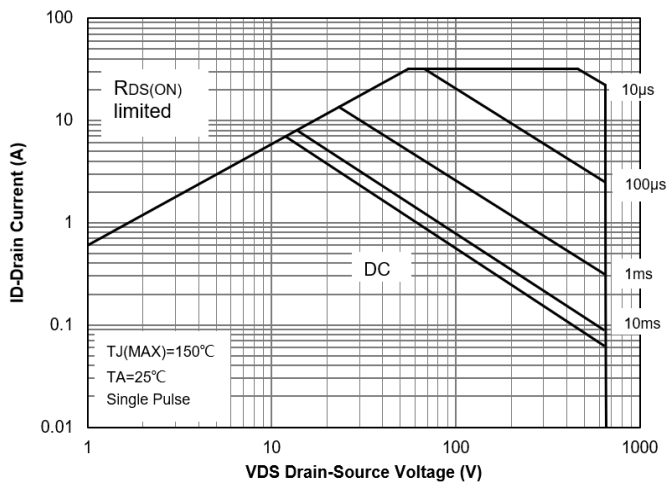

Figure 9. Safe Operation Area (TO-220)

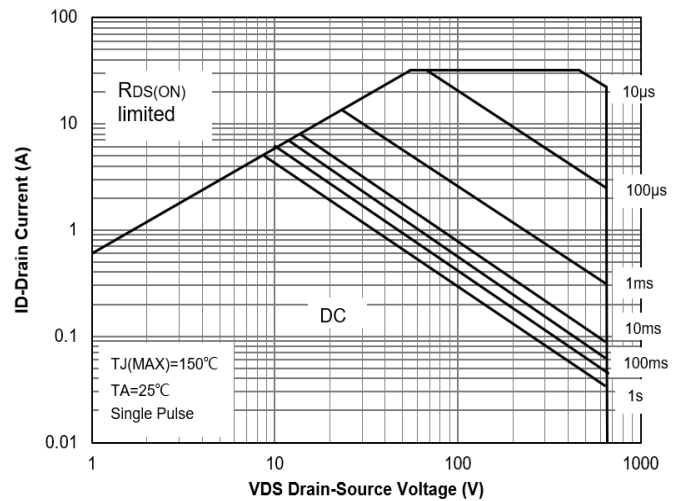

Figure 10. Safe Operation Area (TO-220F)

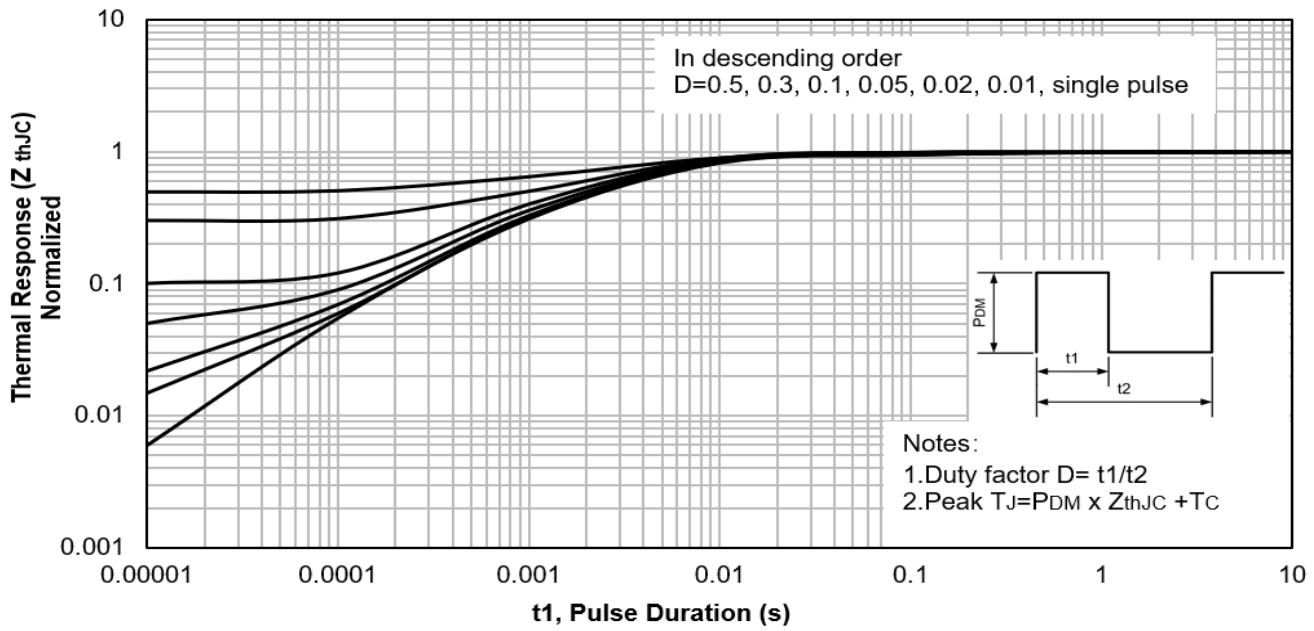

Figure 11. Maximum Effective Transient Thermal Impedance ,Junction-to-Case (TO-220)

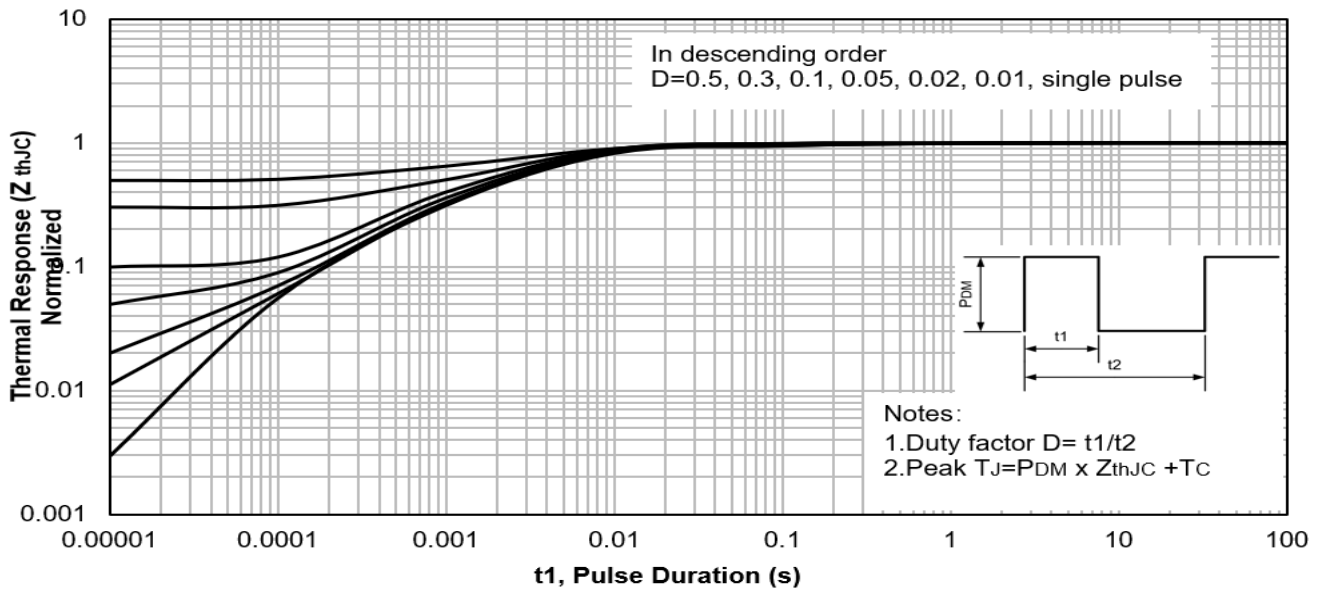
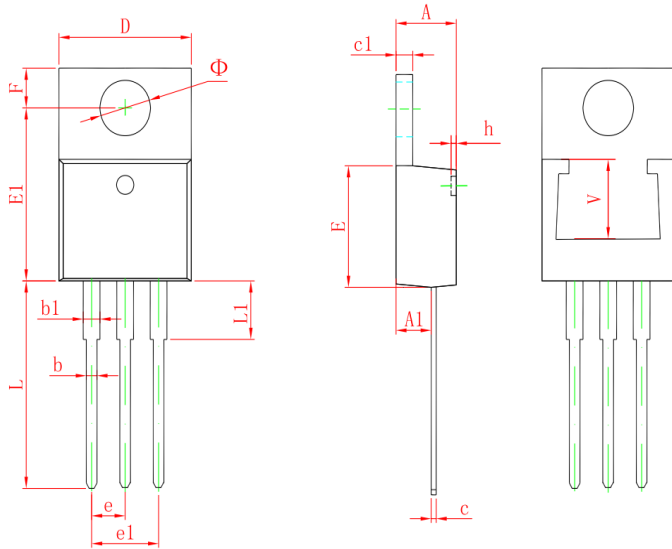

Figure 12. Maximum Effective Transient Thermal Impedance ,Junction-to-Case (TO-220F)

TO-220 Package Outline Drawing



Symbol	Millimeters		Inches	
	Min.	Max.	Min.	Max.
A	4.470	4.670	0.176	0.184
A1	2.520	2.820	0.099	0.111
b	0.710	0.910	0.028	0.036
b1	1.170	1.370	0.046	0.054
c	0.310	0.530	0.012	0.021
c1	1.170	1.370	0.046	0.054
D	10.010	10.310	0.394	0.406
E	8.500	8.900	0.335	0.350
E1	12.060	12.460	0.475	0.491
e	2.540 TYP.		0.100 TYP.	
e1	4.980	5.180	0.196	0.204
F	2.590	2.890	0.102	0.114
h	0.000	0.300	0.000	0.012
L	13.400	13.800	0.528	0.543
L1	3.560	3.960	0.140	0.156
Φ	3.735	3.935	0.147	0.155
V	5.600 REF.		0.220 REF.	

TO-220F Package Outline Drawing

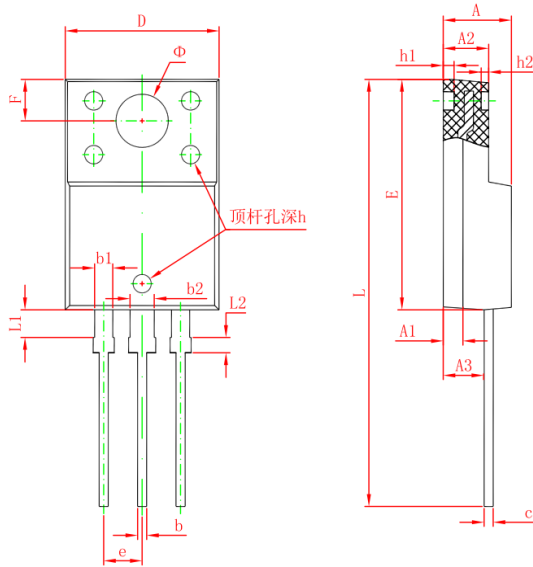

Symbol	Millimeters		Inches	
	Min.	Max.	Min.	Max.
A	4.300	4.700	0.169	0.185
A1	1.300 REF.		0.051 REF.	
A2	2.800	3.200	0.110	0.126
A3	2.500	2.900	0.098	0.114
b	0.500	0.750	0.020	0.030
b1	1.100	1.350	0.043	0.053
b2	1.500	1.750	0.059	0.069
c	0.500	0.750	0.020	0.030
D	9.960	10.360	0.392	0.408
E	14.800	15.200	0.583	0.598
e	2.540 TYP.		0.100 TYP.	
F	2.700 REF.		0.106 REF.	
Φ	3.500 REF.		0.138 REF.	
h	0.000	0.300	0.000	0.012
h1	0.800 REF.		0.031 REF.	
h2	0.500 REF.		0.020 REF.	
L	28.000	28.400	1.102	1.118
L1	1.700	1.900	0.067	0.075
L2	0.900	1.100	0.035	0.043

Contact Information

Applied Power Microelectronics Inc.

Website: <http://www.appliedpowermicro.com>

Email: sales@appliedpowermicro.com

Phone: +86 (0519) 8399 3606