

### Description

CM2324 is the N-Channel enhancement mode power field effect transistors with high cell density, trench technology. This high density process and design have been optimized switching performance and especially tailored to minimize on-state resistance.

### Features

- $V_{DS}$ : 100V
- $I_D$ : 1.8A
- $R_{DS(on)}$  (@ $V_{GS}=10V$ ) : < 280m $\Omega$
- $R_{DS(on)}$  (@ $V_{GS}=4.5V$ ) : < 310m $\Omega$
- High density cell design for extremely low  $R_{DS(on)}$
- Excellent on-resistance and DC current capability

### Equivalent Circuit and Pin Configuration

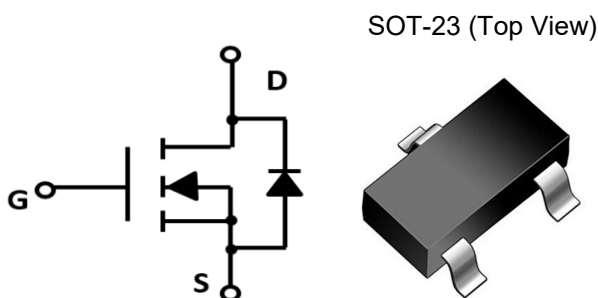

### Applications

- Cellular Handsets and Accessories
- Personal Digital Assistants
- Portable Instrumentation
- Load switch

### Marking Information

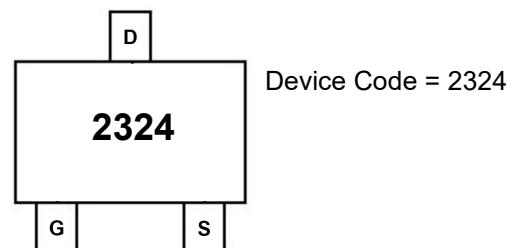

### Ordering Information

Part Number	Packaging	Reel Size
CM2324	3000/Tape & Reel	7 inch

### Absolute Maximum Ratings (TA=25 °C unless otherwise noted)

Parameter	Symbol	Maximum	Unit	
Drain-source Voltage	$V_{DS}$	100	V	
Gate-source Voltage	$V_{GS}$	$\pm 20$	V	
Continuous Drain Current	$I_D$	$T_A=25^\circ C$	1.8	A
		$T_A=70^\circ C$	1.5	A
Pulsed Drain Current <sup>(1)</sup>	$I_{DM}$	7.2	A	
Total Power Dissipation @ $T_A=25^\circ C$ <sup>(2)</sup>	$P_D$	1.4	W	
Thermal Resistance Junction-to-Ambient <sup>(2)</sup>	$R_{\theta JA}$	90	$^\circ C/W$	
Junction and Storage Temperature Range	$T_J, T_{STG}$	-55 to +150	$^\circ C$	

**Electrical Characteristics (T<sub>J</sub>=25 °C unless otherwise noted)**

Parameter	Symbol	Conditions	Min	Typ	Max	Units
<b>Static Parameter</b>						
Drain-Source Breakdown Voltage	BV <sub>DSS</sub>	V <sub>GS</sub> =0V, I <sub>D</sub> =250μA	100			V
Zero Gate Voltage Drain Current	I <sub>DSS</sub>	V <sub>DS</sub> =100V, V <sub>GS</sub> =0V, T <sub>C</sub> =25°C			1	μA
Gate-Body Leakage Current	I <sub>GSS</sub>	V <sub>GS</sub> =±20V, V <sub>DS</sub> =0V			±100	nA
Gate Threshold Voltage	V <sub>GS(th)</sub>	V <sub>DS</sub> =V <sub>GS</sub> , I <sub>D</sub> =250μA	1.0		3.0	V
Static Drain-Source on-Resistance	R <sub>DS(on)</sub>	V <sub>GS</sub> =10V, I <sub>D</sub> =1.8A		250	280	mΩ
		V <sub>GS</sub> =4.5V, I <sub>D</sub> =1.8A		260	310	
Diode Forward Voltage	V <sub>SD</sub>	I <sub>S</sub> =1.8A, V <sub>GS</sub> =0V		0.8	1.2	V
Maximum Body-Diode Continuous Current	I <sub>S</sub>				1.8	A
<b>Dynamic Parameters</b>						
Input Capacitance	C <sub>iss</sub>	V <sub>DS</sub> =50V, V <sub>GS</sub> =0V, f=1MHz		380		pF
Output Capacitance	C <sub>oss</sub>			16		
Reverse Transfer Capacitance	C <sub>rss</sub>			11		
<b>Switching Parameters</b>						
Total Gate Charge	Q <sub>g</sub>	V <sub>GS</sub> =10V, V <sub>DS</sub> =50V, I <sub>D</sub> =1.8A		8.9		nC
Gate Source Charge	Q <sub>gs</sub>			1.1		
Gate Drain Charge	Q <sub>gd</sub>			2.5		
Turn-on Delay Time	t <sub>D(on)</sub>	V <sub>GS</sub> =10V, V <sub>DD</sub> =50V, I <sub>D</sub> =1.3A, R <sub>L</sub> =39Ω, R <sub>GEN</sub> =1Ω		14		ns
Turn-on Rise Time	t <sub>r</sub>			54		
Turn-off Delay Time	t <sub>D(off)</sub>			18		
Turn-off Fall Time	t <sub>f</sub>			11		

Noted: (1) Pulse Test: Pulse Width ≤ 300us, Duty cycle ≤ 2%.

(2) Device mounted on FR-4 PCB, 1 inch x 0.85 inch x 0.062 inch. With 2oz Copper, t ≤ 10s

**Typical Performance Characteristics**

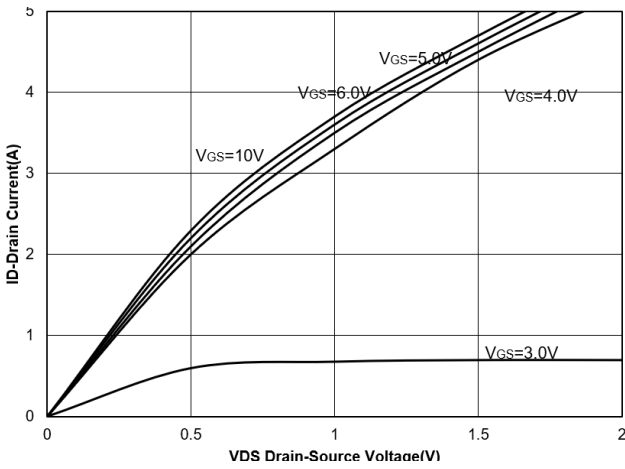

Figure 1. Output Characteristics

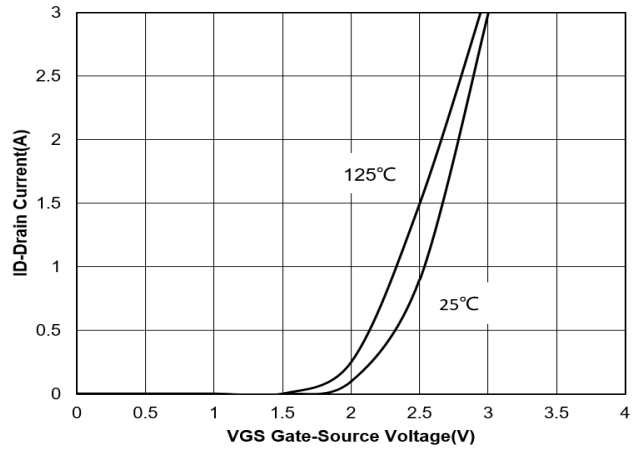

Figure 2. Transfer Characteristics

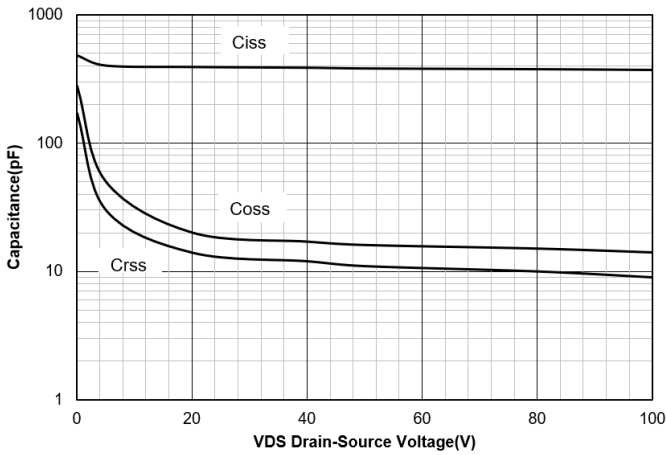

Figure 3. Capacitance Characteristics

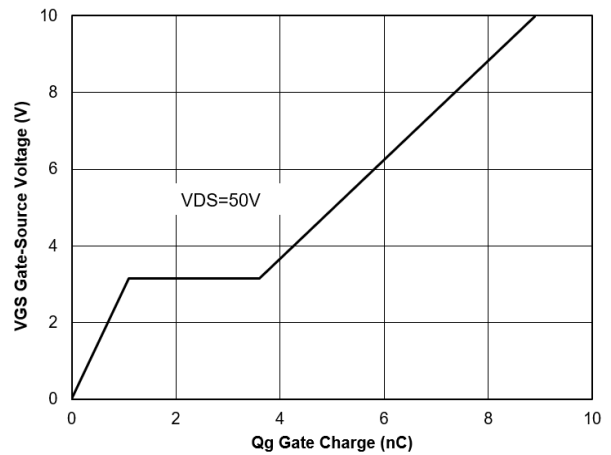

Figure 4. Gate Charge

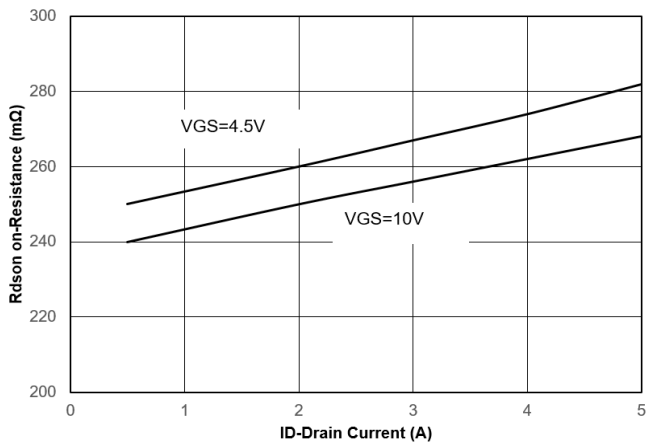

Figure 5. Drain-Source on Resistance

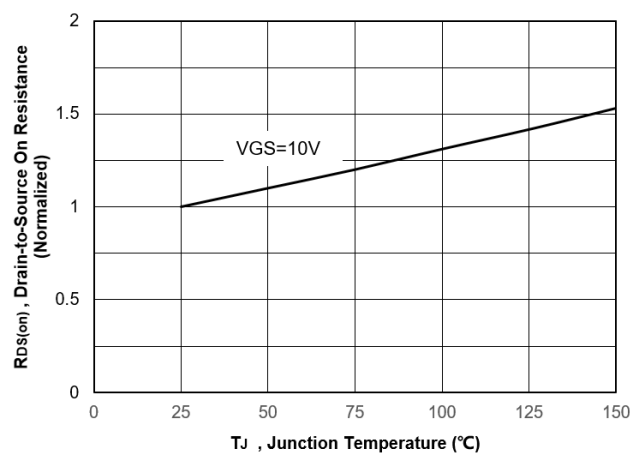

Figure 6. Normalized On-Resistance Vs. Temperature

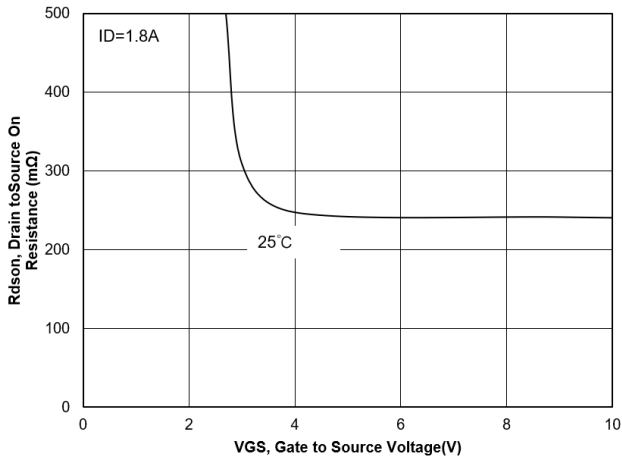

Figure 7. On-Resistance VS Gate-Source Voltage

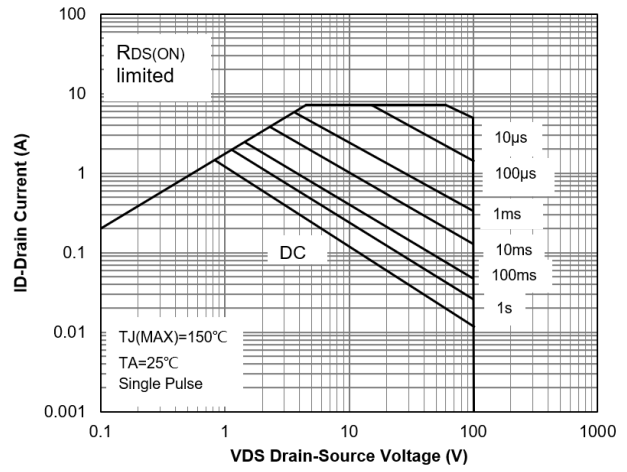

Figure 8. Safe Operation Area

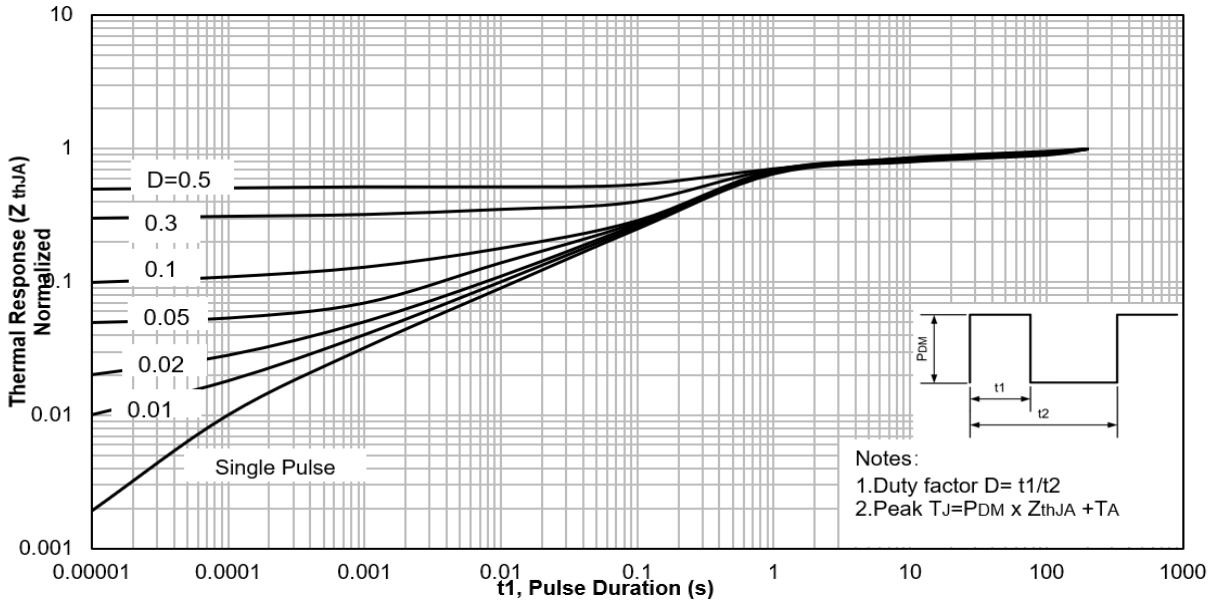

Figure 9. Maximum Effective Transient Thermal Impedance ,Junction-to-Ambient

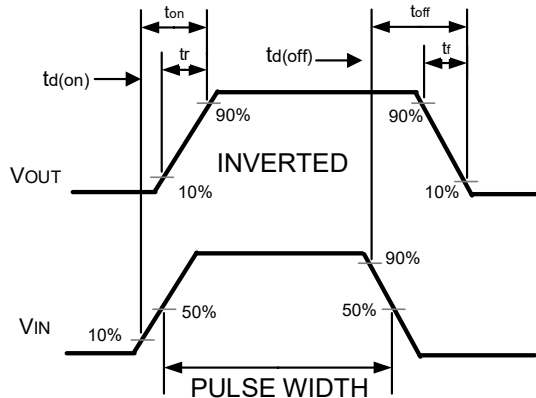
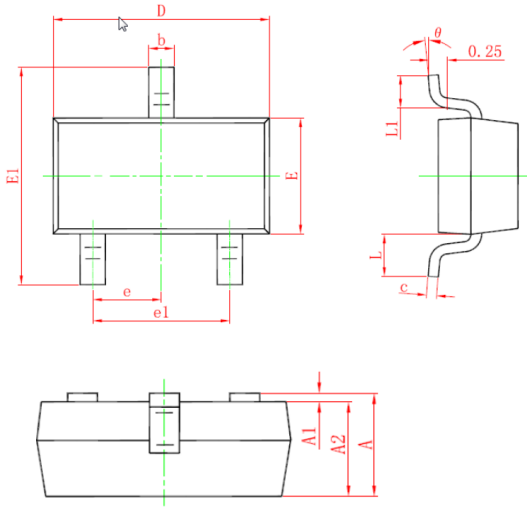

Figure 10. Switching wave

**SOT-23 Package Outline Drawing**

(Unit : mm)

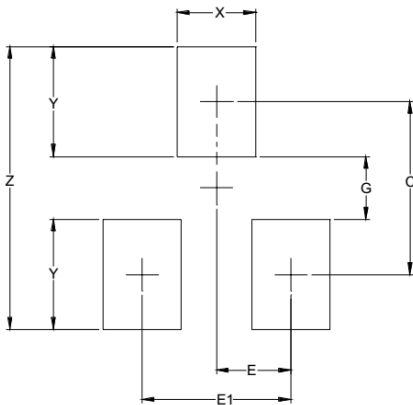

SYM	DIMENSIONS					
	MILLIMETERS			INCHES		
	MIN	NOM	MAX	MIN	NOM	MAX
A	0.90	--	1.15	0.035	--	0.045
A1	0.00	--	0.10	0.000	--	0.004
A2	0.90	--	1.05	0.035	--	0.041
b	0.30	--	0.50	0.012	--	0.020
c	0.08	--	0.15	0.003	--	0.006
D	2.80	--	3.00	0.110	--	0.118
E	1.20	--	1.40	0.047	--	0.055
E1	2.25	--	2.55	0.089		0.100
e	0.95TYP			0.037TYP		
e1	1.80	--	2.00	0.071	--	0.079
L	0.55REF			0.022REF		
L1	0.30	--	0.50	0.012	--	0.020
Theta	0°	--	8°	0°	--	8°

**Suggested Land Pattern**

SYM	DIMENSIONS	
	INCHES	MILLIMETERS
C	0.087	2.20
E	0.037	0.95
E1	0.075	1.90
G	0.031	0.80
X	0.039	1.00
Y	0.055	1.40
Z	0.141	3.60