

### Description

The AU3321P0 is a bi-directional TVS diode, utilizing leading monolithic silicon technology to provide fast response time and low ESD clamping voltage, making this device an ideal solution for protecting voltage sensitive data and power line. The AU3321P0 complies with the IEC 61000-4-2 (ESD) with  $\pm 30\text{kV}$  air and  $\pm 30\text{kV}$  contact discharge. It is assembled into an ultra-small 0.6x0.3x0.3mm lead-free DFN package. The ultra small size and high ESD surge protection make AU3321P0 an ideal choice to replace 0201 size multilayer varistors (MLVs) and protect cell phone, digital cameras, audio players and many other portable applications.

### Features

- Ultra small package: 0.6x0.3x0.3mm
- Very low capacitance
- Protects one data or power line
- Ultra low leakage: nA level
- Operating voltage: 3.3V
- Low clamping voltage
- 2-pin leadless package
- Complies with following standards:
  - IEC 61000-4-2 (ESD) immunity test
    - Air discharge:  $\pm 30\text{kV}$
    - Contact discharge:  $\pm 30\text{kV}$
  - IEC61000-4-5 (Lightning) 8A (8/20 $\mu\text{s}$ )
- RoHS Compliant

### Equivalent Circuit and Pin Configuration

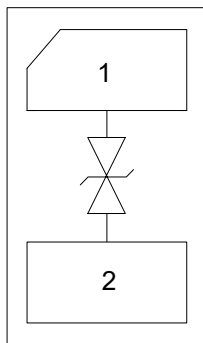

Circuit and Pin Schematic

### Mechanical Characteristics

- Package: DFN0603-2 (0.6x0.3x0.3mm)
- Case Material: “Green” Molding Compound.
- Terminal Connections: See Diagram Below
- Marking Information: See Below

### Applications

- Cellular Handsets and Accessories
- Personal Digital Assistants
- Notebooks and Handhelds
- Portable Instrumentation
- Digital Cameras
- Peripherals
- Audio Players
- Keypads, Side Keys, USB 2.0, LCD Displays

### Marking Information

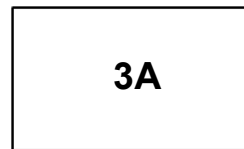

3A = Device Marking Code

### Ordering Information

Part Number	Packaging	Reel Size
AU3321P0	10000/Tape & Reel	7 inch

**Absolute Maximum Ratings (T<sub>A</sub>=25°C unless otherwise specified)**

Parameter	Symbol	Value	Unit
Peak Pulse Power (8/20μs)	Ppk	76	W
Peak Pulse Current (8/20μs)	Ipp	8	A
ESD per IEC 61000-4-2 (Air) ESD per IEC 61000-4-2 (Contact)	VESD	±30 ±30	kV
Operating Temperature Range	TJ	-55 to +125	°C
Storage Temperature Range	Tstg	-55 to +150	°C

**Electrical Characteristics (T<sub>A</sub>=25°C unless otherwise specified)**

Parameter	Symbol	Min	Typ	Max	Unit	Test Condition
Reverse Working Voltage	VRWM			3.3	V	
Breakdown Voltage	VBR	3.8			V	IT = 1mA
Reverse Leakage Current	IR		0.01	0.2	μA	VRWM = 3.3V
Clamping Voltage	VC			6	V	I <sub>PP</sub> = 1A (8 x 20μs pulse)
				8	V	I <sub>PP</sub> = 5A (8 x 20μs pulse)
				9.5	V	I <sub>PP</sub> = 8A (8 x 20μs pulse)
Junction Capacitance	CJ		10	13	pF	VR = 0V, f = 1MHz

**Typical Performance Characteristics ( $T_A=25^\circ\text{C}$  unless otherwise Specified)**

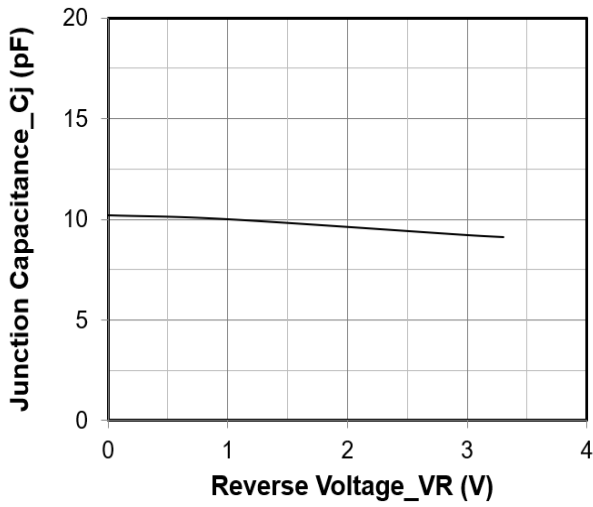

**Junction Capacitance vs. Reverse Voltage**

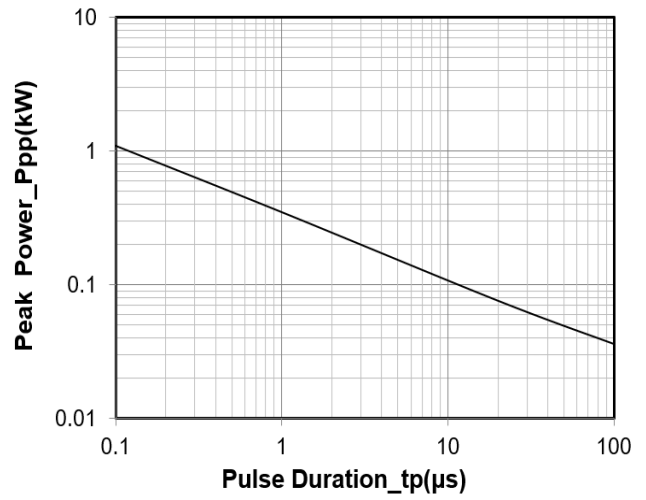

**Peak Pulse Power vs. Pulse Time**

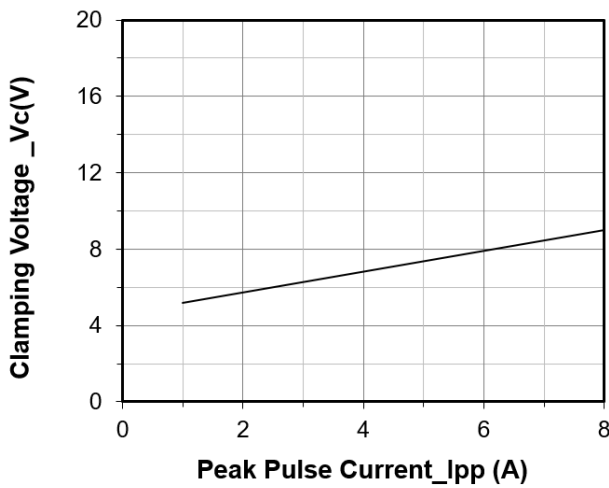

**Clamping Voltage vs. Peak Pulse Current**

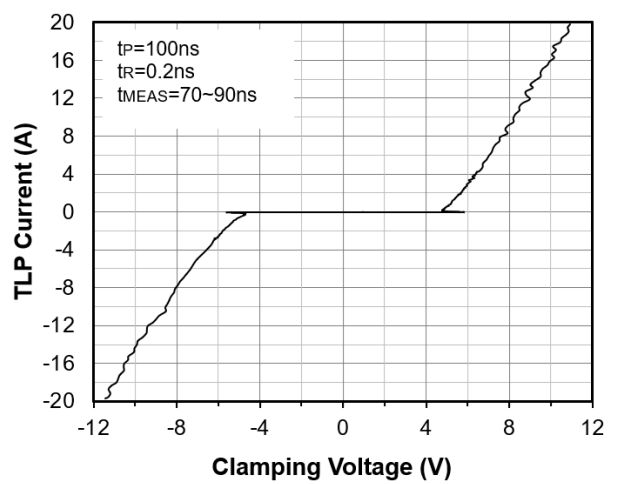

**TLP Measurement**

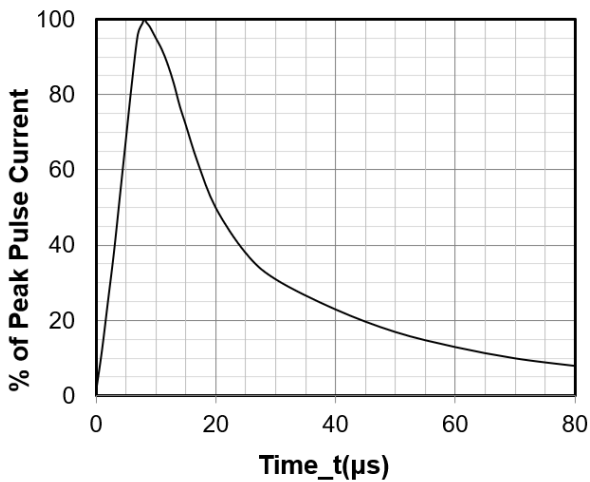

**8 X 20μs Pulse Waveform**

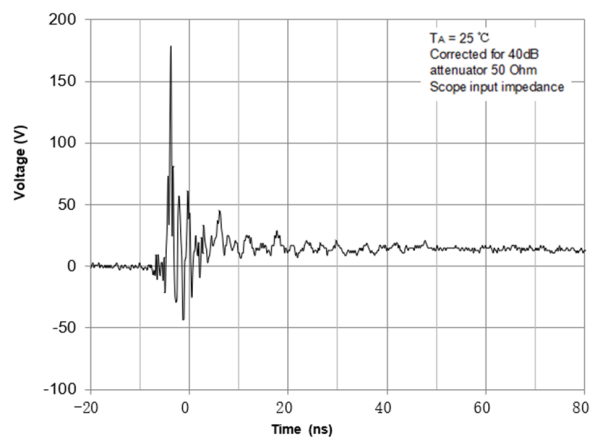

**ESD Clamping Voltage**  
**8 kV Contact per IEC61000-4-2**

### DFN0603-2 Package Outline Drawing

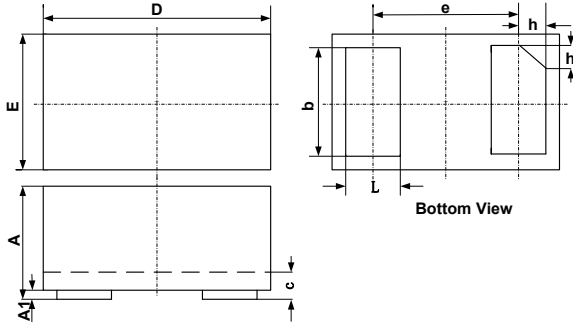

SYM	DIMENSIONS		
	MILLIMETERS		
	MIN	NOM	MAX
A	0.230		0.330
A1	0.000	0.020	0.050
b	0.215	0.245	0.275
c	0.120	0.150	0.180
D	0.550	0.600	0.650
e	0.355 BSC		
E	0.250	0.300	0.350
L	0.160	0.190	0.220
h	0.079 BSC		

### Suggested Land Pattern

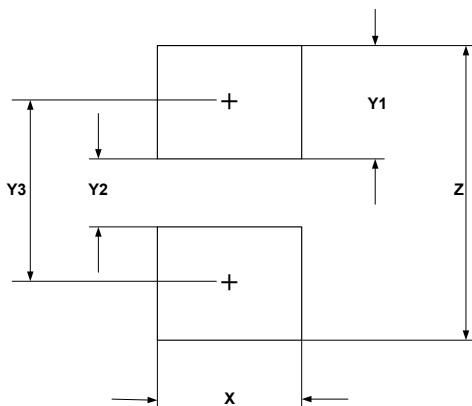

SYM	DIMENSIONS	
	MILLIMETERS	INCHES
X	0.30	0.012
Y1	0.25	0.010
Y2	0.15	0.006
Y3	0.40	0.016
Z	0.65	0.026

### Contact Information

Applied Power Microelectronics Inc.  
 Website: <http://www.appliedpowermicro.com>  
 Email: [sales@appliedpowermicro.com](mailto:sales@appliedpowermicro.com)  
 Phone: +86 (0519) 8399 3606