

### Description

The AU2881D1F-T is a bi-directional TVS diode, utilizing leading monolithic silicon technology to provide fast response time and low ESD clamping voltage, making this device an ideal solution for protecting voltage sensitive data and power lines. The AU2881D1F-T complies with the IEC 61000-4-2 (ESD) with  $\pm 30\text{kV}$  air and  $\pm 30\text{kV}$  contact discharge. It is assembled into a SOD-123FL lead-free package. The small size and high ESD/surge protection make AU2881D1F-T an ideal choice to protect cell phone, digital cameras, audio players and many other portable applications.

### Features

- Protects one data or power line
- Ultra low leakage: nA level
- Operating voltage: 28V
- Ultra low clamping voltage
- Complies with following standards:
  - IEC 61000-4-2 (ESD) immunity test
    - Air discharge:  $\pm 30\text{kV}$
    - Contact discharge:  $\pm 30\text{kV}$
  - IEC61000-4-5 (Lightning) 250A (8/20 $\mu\text{s}$ )
- RoHS Compliant

### Pin Configuration

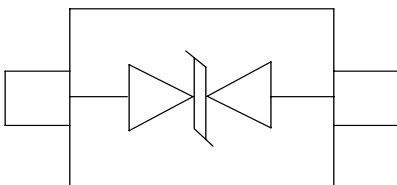

### Mechanical Characteristics

- Package: SOD-123FL
- Lead Finish: Matte Tin
- Case Material: "Green" Molding Compound.
- Terminal Connections: See Diagram Below
- Marking Information: See Below

### Applications

- Fast-charge battery chargers
- Power management system
- Cellular Handsets and Accessories
- Personal Digital Assistants
- Notebooks and Handhelds
- Portable Instrumentation
- Digital Cameras
- Peripherals

### Marking Information



28CA = Device Marking Code

### Ordering Information

Part Number	Packaging	Reel Size
AU2881D1F-T	3000/Tape & Reel	7 inch

**Absolute Maximum Ratings ( $T_A=25^\circ\text{C}$  unless otherwise specified)**

Parameter	Symbol	Value	Unit
Peak Pulse Power (8/20 $\mu\text{s}$ )	Ppk	10000	W
Peak Pulse Current (8/20 $\mu\text{s}$ )	Ipp	250	A
ESD per IEC 61000-4-2 (Air)	VESD	$\pm 30$	kV
ESD per IEC 61000-4-2 (Contact)		$\pm 30$	
Operating Temperature Range	TJ	-40 to +125	$^\circ\text{C}$
Storage Temperature Range	Tstg	-40 to +125	$^\circ\text{C}$

**Electrical Characteristics ( $T_A=25^\circ\text{C}$  unless otherwise specified)**

Parameter	Symbol	Min	Typ	Max	Unit	Test Condition
Reverse Working Voltage	VRWM			28	V	
Breakdown Voltage	VBR	30			V	IT = 1mA
Reverse Leakage Current	IR			1.0	$\mu\text{A}$	VRWM = 28V
Clamping Voltage	VC		34	37	V	I <sub>PP</sub> = 160A (8 x 20 $\mu\text{s}$ pulse)
			39	42	V	I <sub>PP</sub> = 250A (8 x 20 $\mu\text{s}$ pulse)
Junction Capacitance	CJ		200		pF	VR = 0V, f = 1MHz

**Typical Performance Characteristics (T<sub>A</sub>=25°C unless otherwise Specified)**

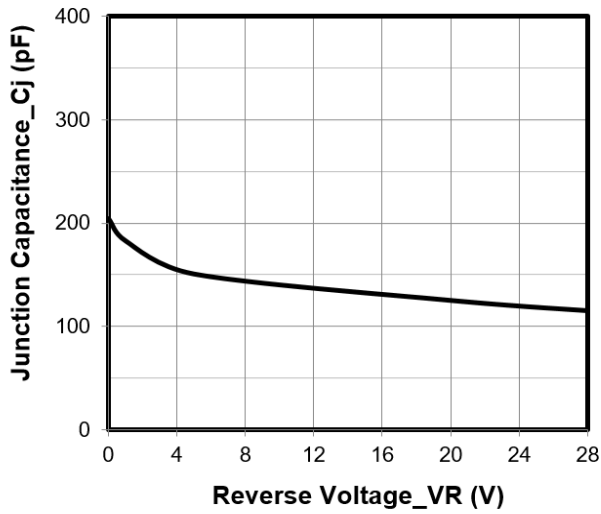

**Junction Capacitance vs. Reverse Voltage**

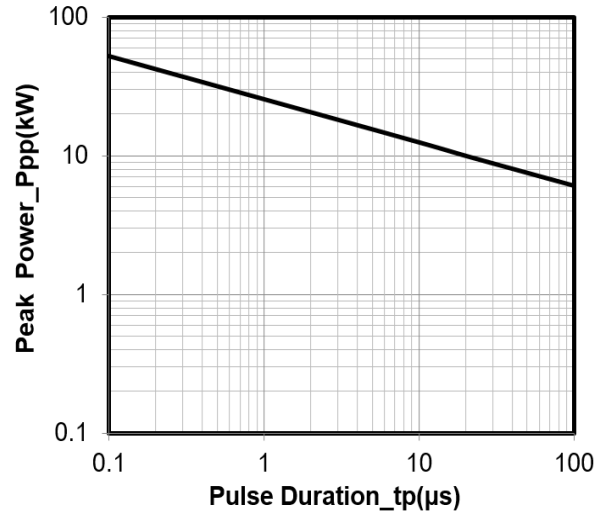

**Peak Pulse Power vs. Pulse Time**

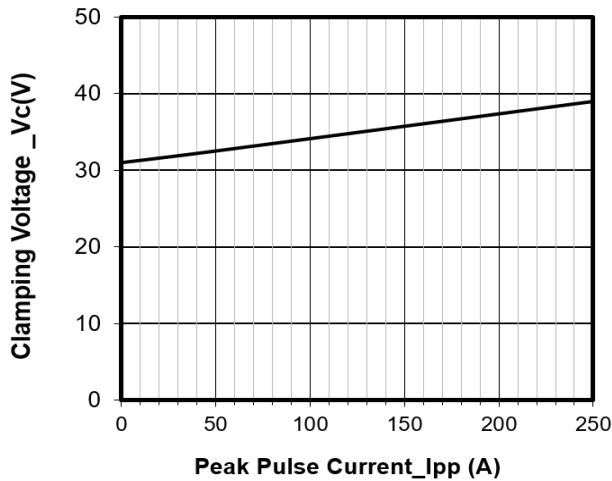

**Clamping Voltage vs. Peak Pulse Current**

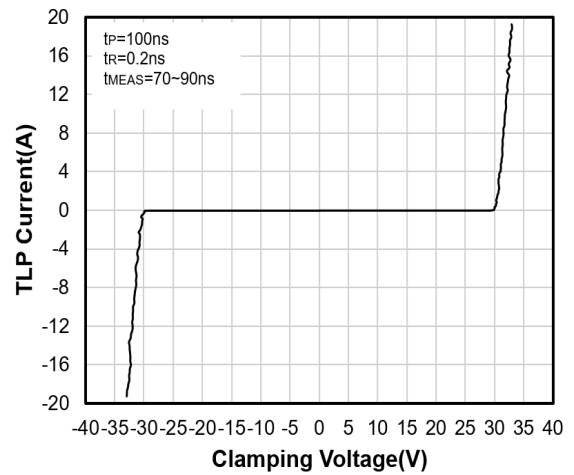

**TLP Curve**

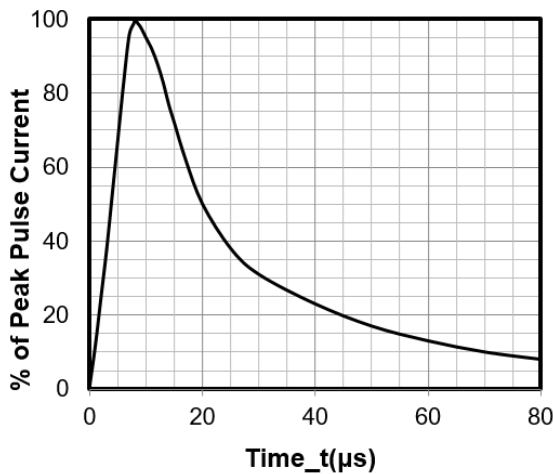

**8 X 20μs Pulse Waveform**

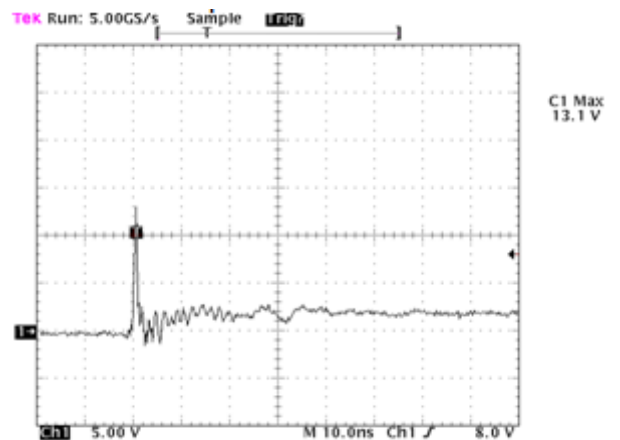

**Note: Data is taken with a 10x attenuator  
ESD Clamping Voltage**

**8 kV Contact per IEC61000-4-2**

### SOD-123FL Package Outline Drawing

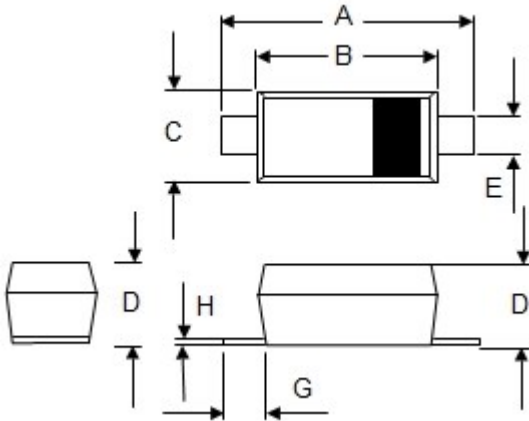

SYM	DIMENSIONS			
	MILLIMETERS		INCHES	
	MIN	MAX	MIN	MAX
A	3.40	3.95	0.142	0.155
B	2.50	2.90	0.098	0.114
C	1.40	1.95	0.055	0.077
D	0.80	1.00	0.031	0.040
E	0.50	1.10	0.020	0.043
G	0.25	--	0.010	--
H	--	0.20	--	0.008

### Suggested Land Pattern

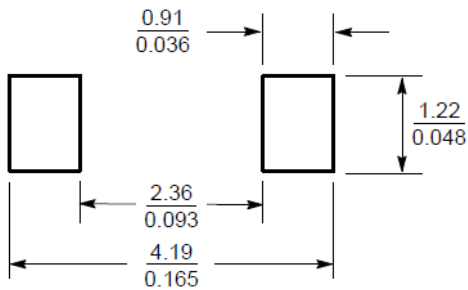

SCALE 10:1 ( $\frac{\text{mm}}{\text{inches}}$ )

### Contact Information

Applied Power Microelectronics Inc.

Website: <http://www.appliedpowermicro.com>

Email: [sales@appliedpowermicro.com](mailto:sales@appliedpowermicro.com)

Phone: +86 (0519) 8399 3606