

Description

The AU2471D3 is an uni-directional TVS diode, utilizing leading monolithic silicon technology to provide fast response time and ultra low ESD clamping voltage, making this device an ideal solution for protecting voltage sensitive data and power line. The AU2471D3 complies with the IEC 61000-4-2 (ESD) with $\pm 30\text{kV}$ air and $\pm 30\text{kV}$ contact discharge. It is assembled into an ultra-small SOD-323 lead-free package. The small size and high ESD surge protection make AU2471D3 an ideal choice to protect cell phone, digital cameras, audio players and many other portable applications.

Features

- Protects one data line
- Ultra low leakage: nA level
- Operating voltage: 24V
- Ultra low clamping voltage
- Complies with following standards:
 - IEC 61000-4-2 (ESD) immunity test
 - Air discharge: $\pm 30\text{kV}$
 - Contact discharge: $\pm 30\text{kV}$
 - IEC61000-4-5 (Lightning) 35A (8/20 μs)
- RoHS Compliant

Mechanical Characteristics

- Package: SOD-323
- Lead Finish: Matte Tin
- Case Material: “Green” Molding Compound.
- Terminal Connections: See Diagram Below
- Marking Information: See Below

Applications

- Cellular Handsets and Accessories
- Personal Digital Assistants
- Notebooks, Desktops, Servers
- Portable Instrumentation
- Digital Cameras
- Analog Inputs
- Audio Players
- Keypads, Side Keys, LCD Displays
- Laser Diode Protection

Marking Information

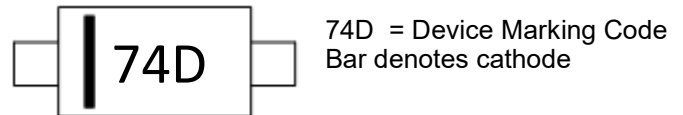

Ordering Information

Part Number	Packaging	Reel Size
AU2471D3	3000/Tape & Reel	7 inch

Dimensions and Pin Configuration

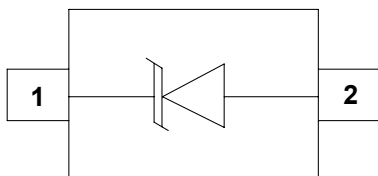

SOD-323 (Top View)

Circuit and Pin Schematic

Absolute Maximum Ratings (T_A=25°C unless otherwise specified)

Parameter	Symbol	Value	Unit
Peak Pulse Power (8/20μs)	P _{pk}	1875	W
Peak Pulse Current (8/20μs)	I _{pp}	35	A
ESD per IEC 61000-4-2 (Air)	V _{ESD}	±30	kV
ESD per IEC 61000-4-2 (Contact)		±30	
Operating Temperature Range	T _J	-55 to +125	°C
Storage Temperature Range	T _{stg}	-55 to +150	°C

Electrical Characteristics (T_A=25°C unless otherwise specified)

Parameter	Symbol	Min	Typ	Max	Unit	Test Condition
Reverse Working Voltage	V _{RWM}			24	V	
Breakdown Voltage	V _{BR}	26.7			V	I _T = 1mA
Reverse Leakage Current	I _R			0.2	μA	V _{RWM} = 24V
Forward Voltage	V _F			1.2	V	I _F = 10mA
Clamping Voltage	V _C			42	V	I _{PP} = 10A (8 x 20μs pulse)
Clamping Voltage	V _C			54	V	I _{PP} = 35A (8 x 20μs pulse)
Junction Capacitance	C _J			200	pF	V _R = 0V, f = 1MHz

Typical Performance Characteristics (T_A=25°C unless otherwise Specified)

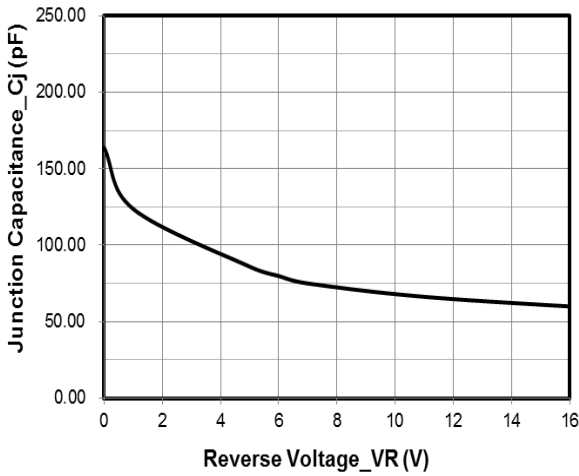

Junction Capacitance vs. Reverse Voltage

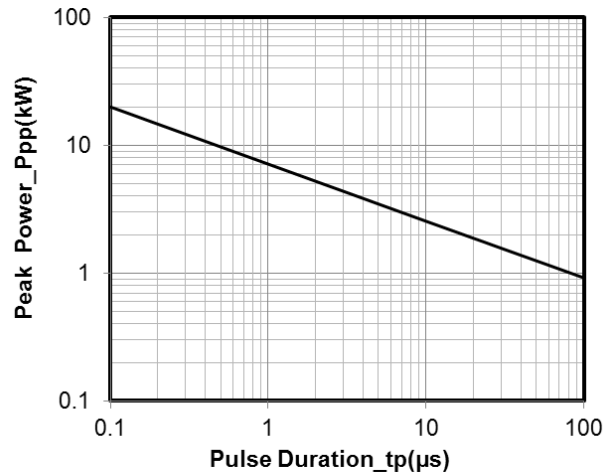

Peak Pulse Power vs. Pulse Time

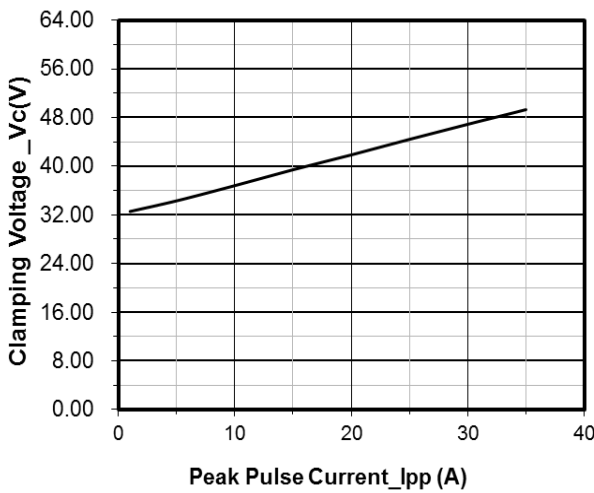

Clamping Voltage vs. Peak Pulse Current

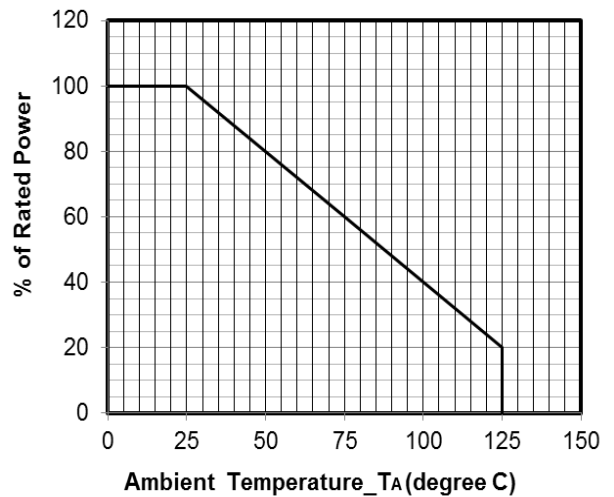

Power Derating Curve

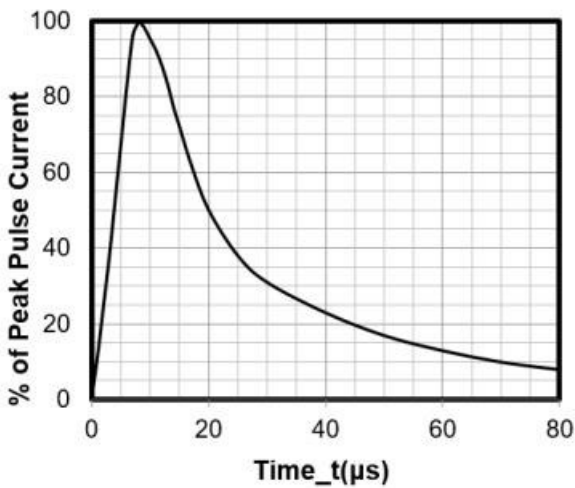

8 X 20μs Pulse Waveform

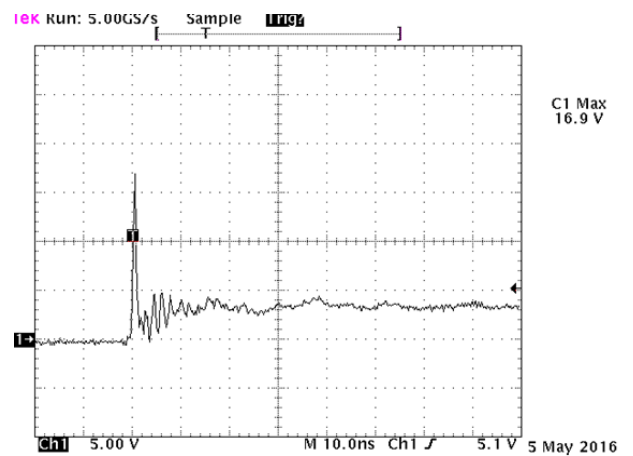

**Note: Data is taken with a 10x attenuator
ESD Clamping Voltage
8 kV Contact per IEC61000-4-2**

SOD-323 Package Outline Drawing

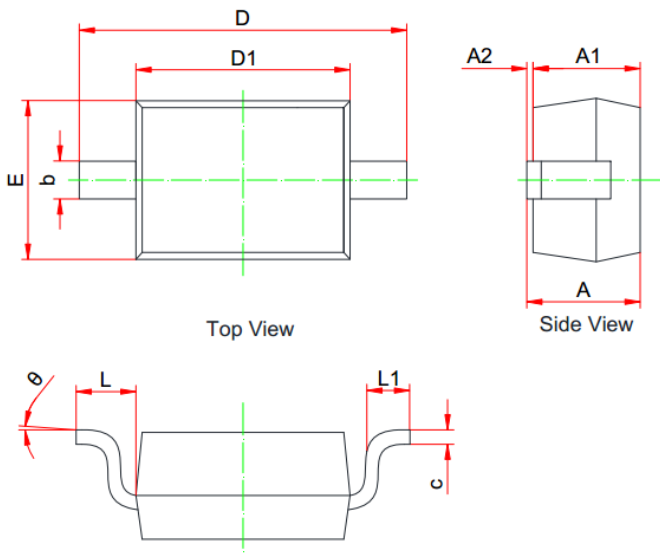

SYM	MILLIMETERS		
	MIN	NOM	MAX
A	0.800	--	1.100
A1	0.800	--	0.900
A2	0.000	--	0.100
b	0.250	--	0.400
c	0.080	--	0.177
D1	1.600	1.700	1.800
D	2.300	--	2.800
E	1.150	--	1.400
L	0.475REF		
L1	0.100	--	0.500
Θ	0°	--	8°

Suggested Land Pattern



Unit: mm

Contact Information

Applied Power Microelectronics Inc.

Website: <http://www.appliedpowermicro.com>

Email: sales@appliedpowermicro.com

Phone: +86 (0519) 8399 3606