

Description

The AU0781P1 is a 7V bi-directional TVS diode, utilizing leading monolithic silicon technology to provide fast response time and low ESD clamping voltage, making this device an ideal solution for protecting voltage sensitive data and power line. The AU0781P1 complies with the IEC 61000-4-2 (ESD) with ± 30 kV air and ± 30 kV contact discharge. It is assembled into an ultra-small 1.0x0.6x0.5mm lead-free DFN package. The small size and high ESD surge protection make AU0781P1 an ideal choice to protect cell phone, digital cameras, audio players and many other portable applications.

Features

- Ultra small package: 1.0x0.6x0.5mm
- Protects one data or power line
- Ultra low leakage: nA level
- Operating voltage: 7V
- Low clamping voltage
- 2-pin leadless package
- Complies with following standards:
 - IEC 61000-4-2 (ESD) immunity test
 - Air discharge: ± 30 kV
 - Contact discharge: ± 30 kV
 - IEC61000-4-5 (Lightning) 20A (8/20 μ s)
- RoHS Compliant

Mechanical Characteristics

- Package: DFN1006-2 (1.0x0.6x0.5mm)
- Case Material: “Green” Molding Compound.
- Terminal Connections: See Diagram Below
- Marking Information: See Below

Applications

- Cellular Handsets and Accessories
- Personal Digital Assistants
- Notebooks and Handhelds
- Portable Instrumentation
- Digital Cameras
- Peripherals
- Audio Players

Marking Information

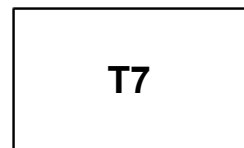

T7 = Device Marking Code

Ordering Information

Part Number	Packaging	Reel Size
AU0781P1	10,000/Tape & Reel	7 inch

Dimensions and Pin Configuration

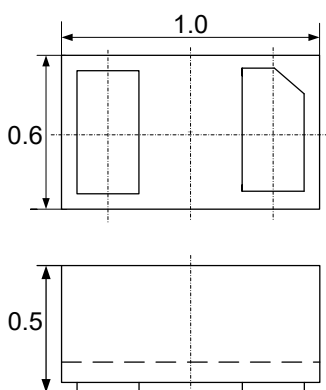

Package Dimensions

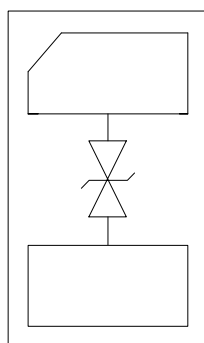

Circuit and Pin Schematic

Absolute Maximum Ratings (T_A=25°C unless otherwise specified)

Parameter	Symbol	Value	Unit
Peak Pulse Power (8/20μs)	Ppk	300	W
Peak Pulse Current (8/20μs)	Ipp	20	A
ESD per IEC 61000-4-2 (Air) ESD per IEC 61000-4-2 (Contact)	VESD	±30 ±30	kV
Operating Temperature Range	TJ	-55 to +125	°C
Storage Temperature Range	Tstg	-55 to +150	°C

Electrical Characteristics (T_A=25°C unless otherwise specified)

Parameter	Symbol	Min	Typ	Max	Unit	Test Condition
Reverse Working Voltage	VRWM			7	V	
Breakdown Voltage	VBR	7.5			V	IT = 1mA
Reverse Leakage Current	IR			0.5	μA	VRWM = 7V
Clamping Voltage	VC			10	V	I _{PP} = 1A (8 x 20μs pulse)
Clamping Voltage	VC			15	V	I _{PP} = 20A (8 x 20μs pulse)
Junction Capacitance	CJ			60	pF	VR = 0V, f = 1MHz

Typical Performance Characteristics (TA=25°C unless otherwise Specified)

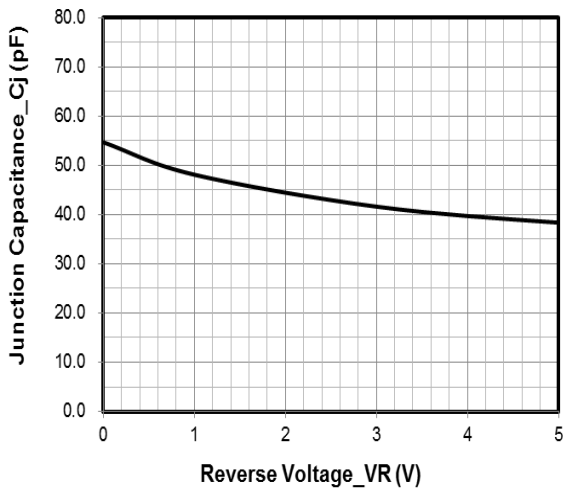

Junction Capacitance vs. Reverse Voltage

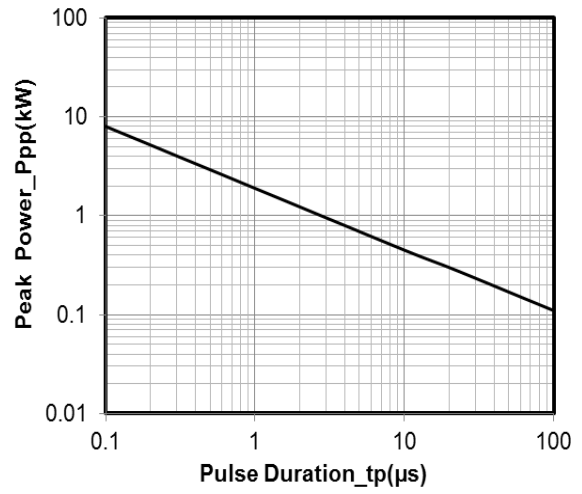

Peak Pulse Power vs. Pulse Time

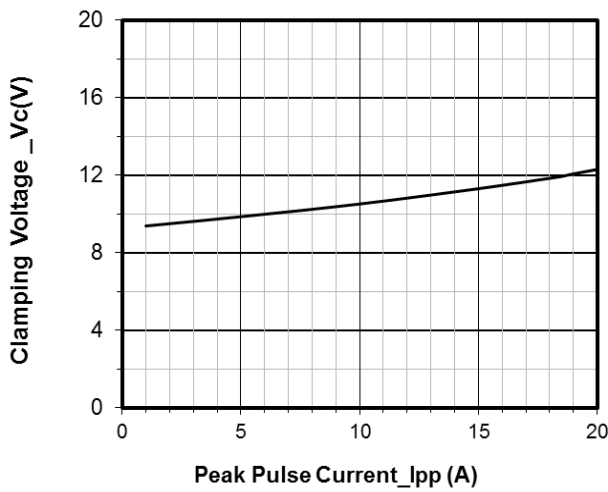

Clamping Voltage vs. Peak Pulse Current

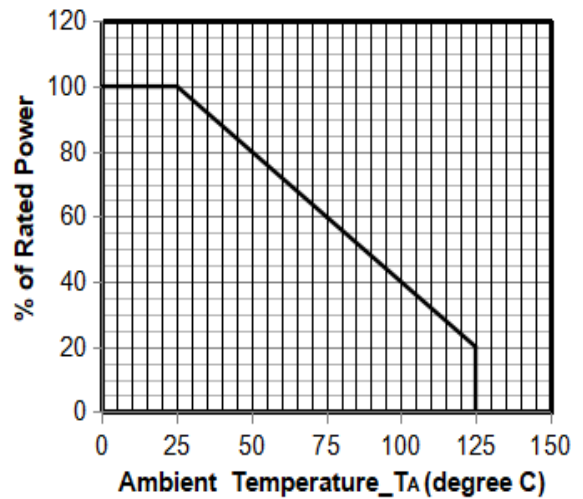

Power Derating Curve

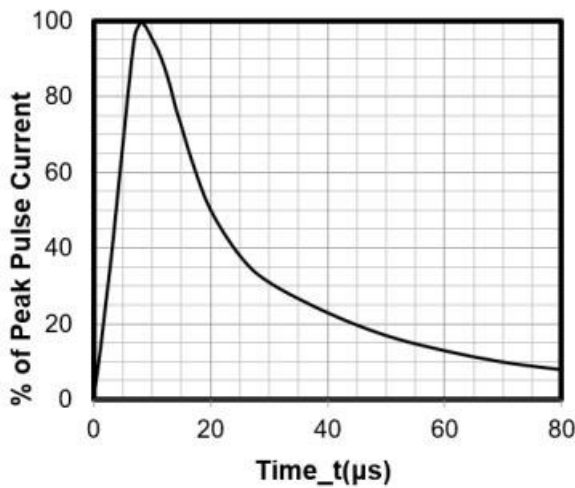

8 X 20μs Pulse Waveform

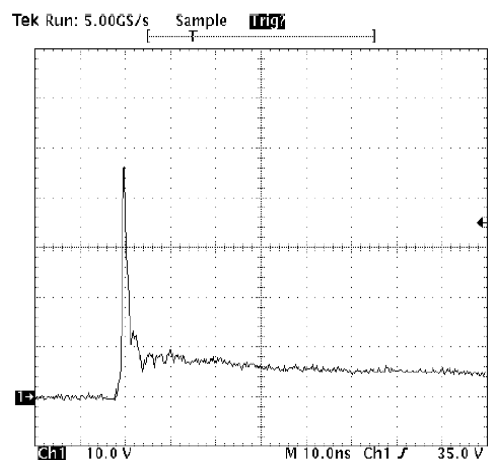

Note: Data is taken with a 10x attenuator

ESD Clamping Voltage

8 kV Contact per IEC61000-4-2

DFN1006-2 Package Outline Drawing

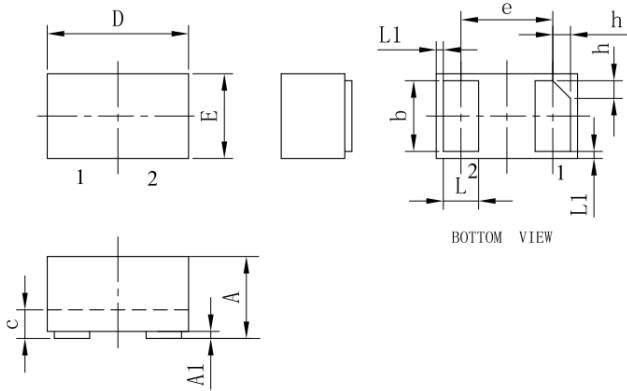

SYM	DIMENSIONS					
	MILLIMETERS			INCHES		
	MIN	NOM	MAX	MIN	NOM	MAX
A	0.45	0.50	0.55	0.018	0.020	0.022
A1	0.00	0.02	0.05	0.000	0.001	0.002
b	0.45	0.50	0.55	0.018	0.020	0.022
c	0.12	0.15	0.18	0.005	0.006	0.007
D	0.95	1.00	1.05	0.037	0.039	0.041
e	0.65 BSC			0.026 BSC		
E	0.55	0.60	0.65	0.022	0.024	0.026
L	0.20	0.25	0.30	0.008	0.010	0.012
L1	0.05REF			0.002REF		
h	0.07	0.12	0.17	0.003	0.005	0.007

Suggested Land Pattern

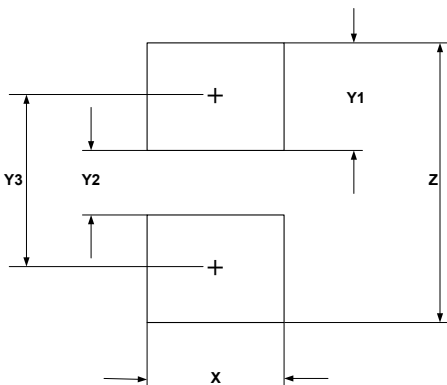

SYM	DIMENSIONS	
	MILLIMETERS	INCHES
X	0.60	0.024
Y1	0.50	0.020
Y2	0.30	0.012
Y3	0.80	0.032
Z	1.30	0.052

Contact Information

Applied Power Microelectronics Inc.

Website: <http://www.appliedpowermicro.com>

Email: sales@appliedpowermicro.com

Phone: +86 (0519) 8399 3606