

Description

The AU0581D5 is a bi-directional TVS diode, utilizing leading monolithic silicon technology to provide fast response time and low ESD clamping voltage, making this device an ideal solution for protecting voltage sensitive data and power line. The AU0581D5 complies with the IEC 61000-4-2 (ESD) with ± 30 kV air and ± 30 kV contact discharge. It is assembled into an ultra-small SOD-523 lead-free package. The small size and high ESD surge protection make AU0581D5 an ideal choice to protect cell phone, digital cameras, audio players and many other portable applications.

Features

- Protects one data or power line
- Ultra low leakage: nA level
- Operating voltage: 5V
- Low clamping voltage
- Complies with following standards:
 - IEC 61000-4-2 (ESD) immunity test
 - Air discharge: ± 30 kV
 - Contact discharge: ± 30 kV
 - IEC61000-4-5 (Lightning) 25A (8/20 μ s)
- RoHS Compliant

Dimensions and Pin Configuration

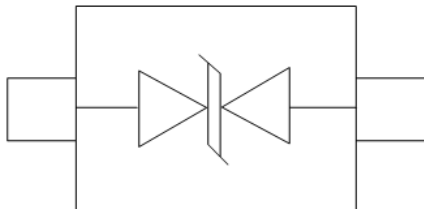

Circuit and Pin Schematic

Mechanical Characteristics

- Package: SOD-523
- Lead Finish: Matte Tin
- Case Material: “Green” Molding Compound.
- Terminal Connections: See Diagram Below
- Marking Information: See Below

Applications

- Cellular Handsets and Accessories
- Personal Digital Assistants
- Notebooks and Handhelds
- Portable Instrumentation
- Digital Cameras
- Peripherals
- Audio Players
- Keypads, Side Keys, LCD Displays, USB2.0

Marking Information



Ordering Information

Part Number	Packaging	Reel Size
AU0581D5	3000/Tape & Reel	7 inch

Absolute Maximum Ratings ($T_A=25^\circ\text{C}$ unless otherwise specified)

Parameter	Symbol	Value	Unit
ESD per IEC 61000-4-2 (Air)	VESD	± 30	kV
ESD per IEC 61000-4-2 (Contact)		± 30	
Peak Pulse Power (8/20 μs)	PPK	350	W
Peak Pulse Current	IPP	25	A
Operating Temperature Range	TJ	-55 to +125	$^\circ\text{C}$
Storage Temperature Range	Tstg	-55 to +150	$^\circ\text{C}$

Electrical Characteristics ($T_A=25^\circ\text{C}$ unless otherwise specified)

Parameter	Symbol	Min	Typ	Max	Unit	Test Condition
Reverse Working Voltage	VRWM			5	V	
Breakdown Voltage	VBR	6			V	$I_T = 1\text{mA}$
Reverse Leakage Current	I_R			0.2	μA	$VRWM = 5\text{V}$
Clamping Voltage	VC			10	V	$IPP = 1\text{A}$ (8 x 20 μs pulse)
Clamping Voltage	VC			14	V	$IPP = 25\text{A}$ (8 x 20 μs pulse)
Junction Capacitance	CJ		55		pF	$V_R = 0\text{V}$, $f = 1\text{MHz}$

Typical Performance Characteristics (T_A=25°C unless otherwise Specified)

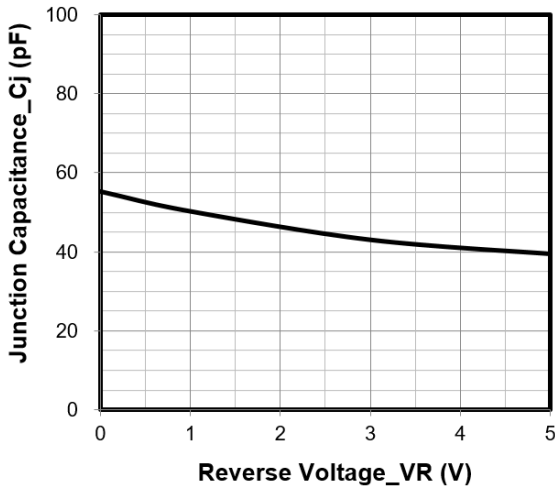

Junction Capacitance vs. Reverse Voltage

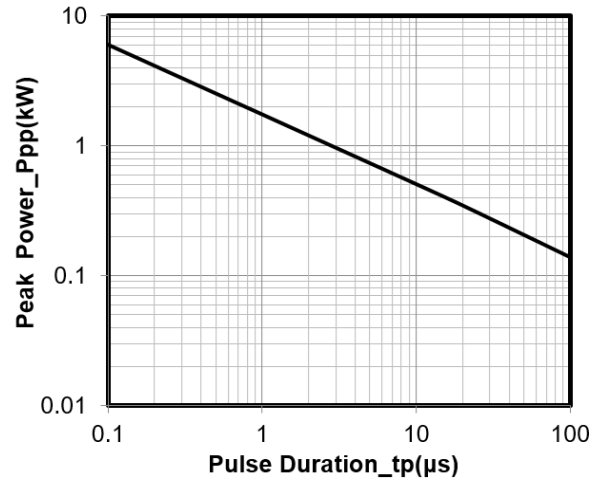

Peak Pulse Power vs. Pulse Time

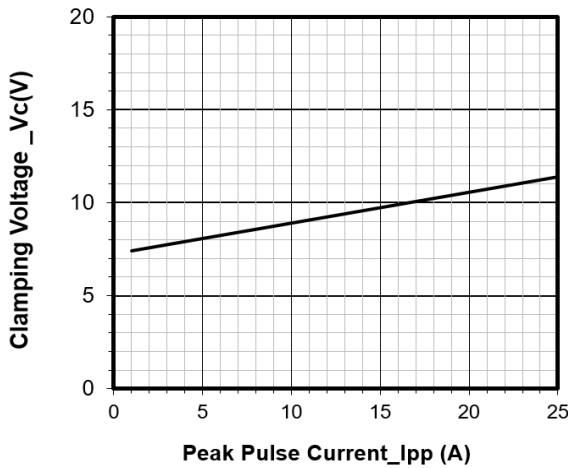

Clamping Voltage vs. Peak Pulse Current

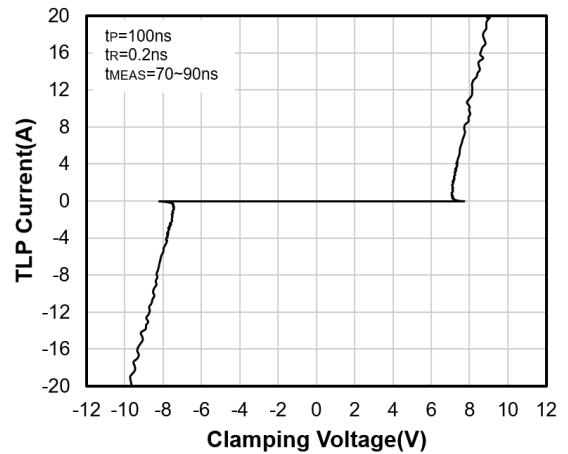

TLP Curve

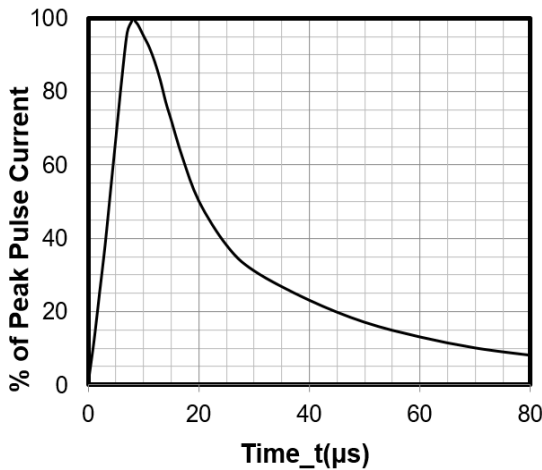

8 X 20μs Pulse Waveform

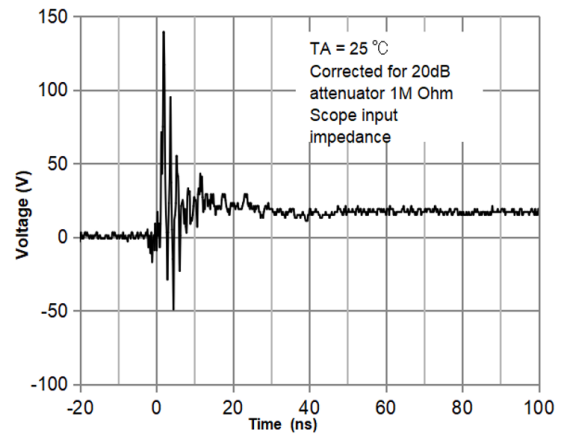

ESD Clamping Voltage

+8 kV Contact per IEC61000-4-2

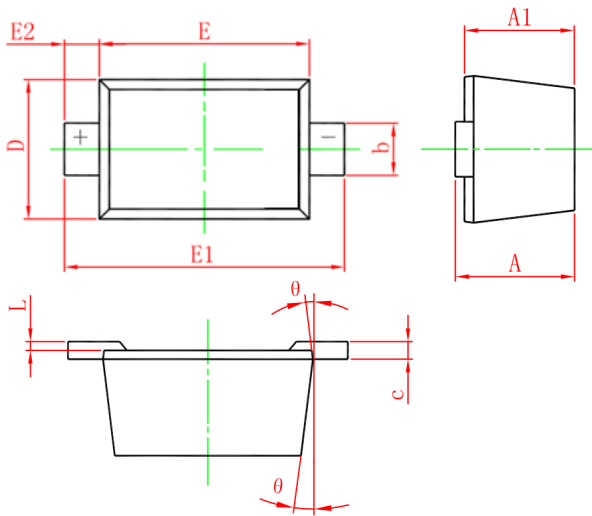
SOD-523 Package Outline Drawing

SYM	DIMENSIONS					
	MILLIMETERS			INCHES		
	MIN	NOM	MAX	MIN	NOM	MAX
A	0.51	--	0.77	0.020	--	0.031
A1	0.50	--	0.70	0.020	--	0.028
b	0.25	--	0.35	0.010	--	0.014
c	0.08	--	0.15	0.003	--	0.006
D	0.75	--	0.85	0.030	--	0.033
E	1.10	--	1.30	0.043	--	0.051
E1	1.50	--	1.70	0.059		0.067
E2	0.20REF			0.008REF		
L	0.01	--	0.07	0.001	--	0.003
Θ	7° REF			7° REF		

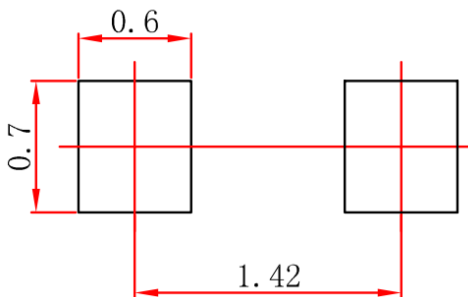
Suggested Land Pattern

Unit: mm

Contact Information

Applied Power Microelectronics Inc.

 Website: <http://www.appliedpowermicro.com>

 Email: sales@appliedpowermicro.com

Phone: +86 (0519) 8399 3606