

Description

The ASM24CXQ is a Bi-directional TVS diode array, utilizing leading monolithic silicon technology to provide fast response time and low ESD clamping voltage, making this device an ideal solution for protecting sensitive semiconductor components from damage. The ASM24CXQ complies with the IEC 61000-4-2 (ESD) with $\pm 30\text{kV}$ air and $\pm 30\text{kV}$ contact discharge. It is assembled into a lead-free SOT-23 package. It is designed to protect components which are connected to data and transmission lines from voltage surges.

Features

- Ultra low leakage: nA level
- Operating voltage: 24V
- Low clamping voltage
- Complies with following standards:
 - IEC 61000-4-2 (ESD) immunity test
 - Air discharge: $\pm 30\text{kV}$
 - Contact discharge: $\pm 30\text{kV}$
 - IEC61000-4-5 (Lightning) 8A (8/20 μs)
- RoHS Compliant
- AEC-Q101 qualified

Mechanical Characteristics

- Package: SOT-23
- Lead Finish: Matte Tin
- Case Material: “Green” Molding Compound.
- Terminal Connections: See Diagram Below
- Marking Information: See Below

Applications

- Cellular Handsets and Accessories
- Notebooks and Handhelds
- Portable Instrumentation
- Set Top Box
- Industrial Controls
- Server and Desktop PC

Marking Information

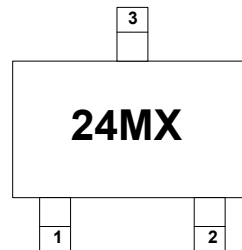

24MX = Device Marking Code

Equivalent Circuit and Pin Configuration

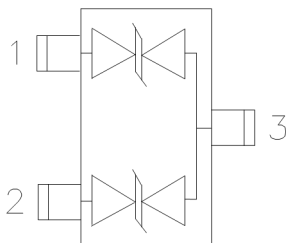

Circuit and Pin Schematic

Ordering Information

Part Number	Packaging	Reel Size
ASM24CXQ	3000/Tape & Reel	7 inch

Absolute Maximum Ratings ($T_A=25^\circ\text{C}$ unless otherwise specified)

Parameter	Symbol	Value	Unit
Peak Pulse Power (8/20 μs)	Ppk	240	W
Peak Pulse Current (8/20 μs)	I _{PP}	8	A
ESD per IEC 61000-4-2 (Air)	VESD	± 30	kV
ESD per IEC 61000-4-2 (Contact)		± 30	
Operating Temperature Range	T _J	-55 to +125	$^\circ\text{C}$
Storage Temperature Range	T _{stg}	-55 to +150	$^\circ\text{C}$

Electrical Characteristics ($T_A=25^\circ\text{C}$ unless otherwise specified)

Parameter	Symbol	Min	Typ	Max	Unit	Test Condition
Reverse Working Voltage	V _{RWM}			24	V	
Breakdown Voltage	V _{BR}	25			V	I _T = 1mA
Reverse Leakage Current	I _R			0.2	μA	V _{RWM} = 24V
Clamping Voltage	V _C			25	V	I _{PP} = 1A (8 x 20 μs pulse)
Clamping Voltage	V _C			30	V	I _{PP} = 8A (8 x 20 μs pulse)
Junction Capacitance	C _J		9		pF	V _R = 0V, f = 1MHz, Pin 1 to Pin 3 or Pin 2 to Pin 3
Junction Capacitance	C _J		5		pF	V _R = 0V, f = 1MHz, Pin 1 to Pin 2

Typical Performance Characteristics (TA=25°C unless otherwise Specified)

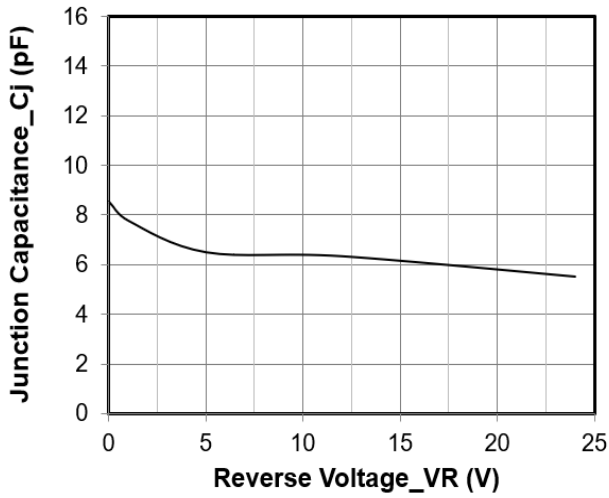

Junction Capacitance vs. Reverse Voltage

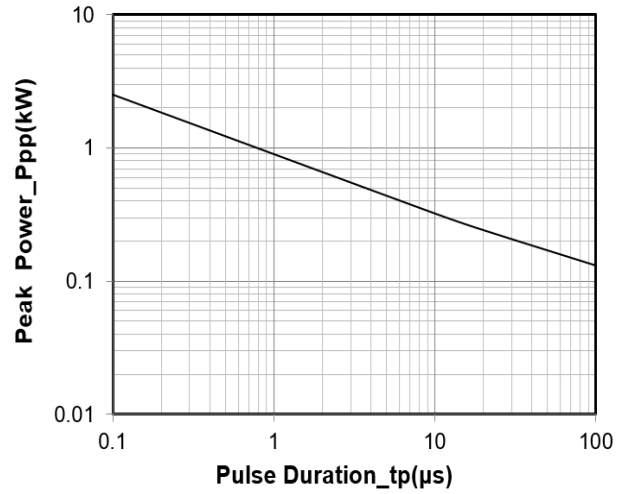

Peak Pulse Power vs. Pulse Time

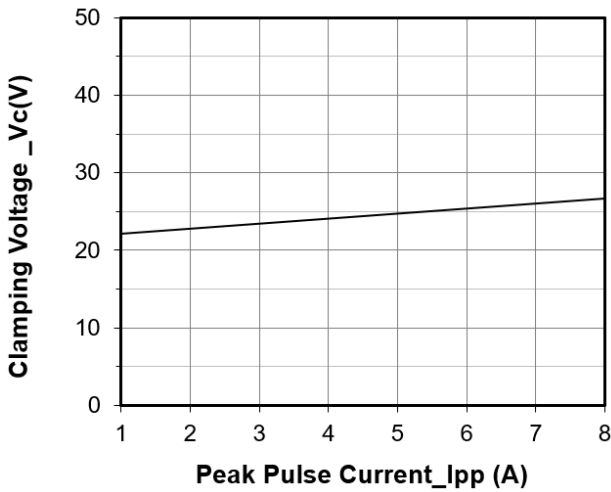

Clamping Voltage vs. Peak Pulse Current (tp = 8/20μs)

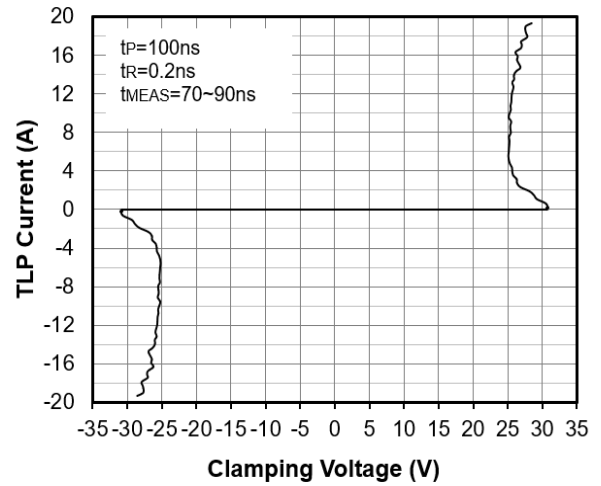

TLP Measurement

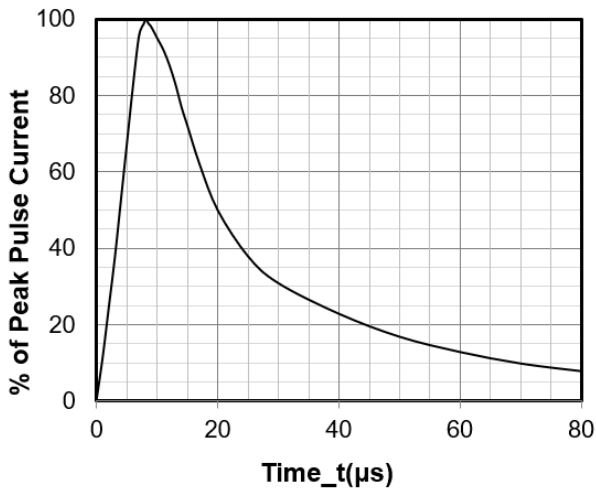

8 X 20μs Pulse Waveform

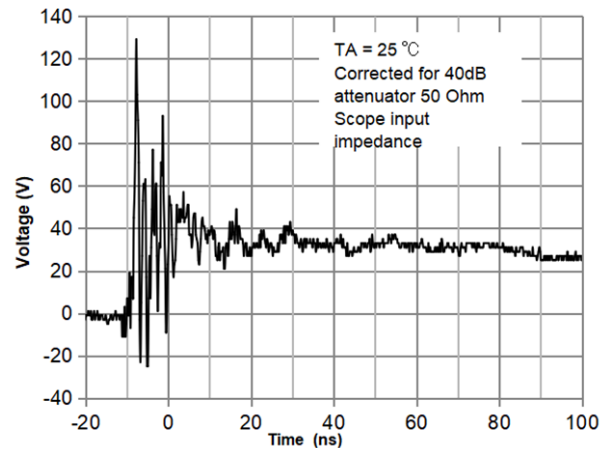

ESD Clamping Voltage
8 kV Contact per IEC61000-4-2

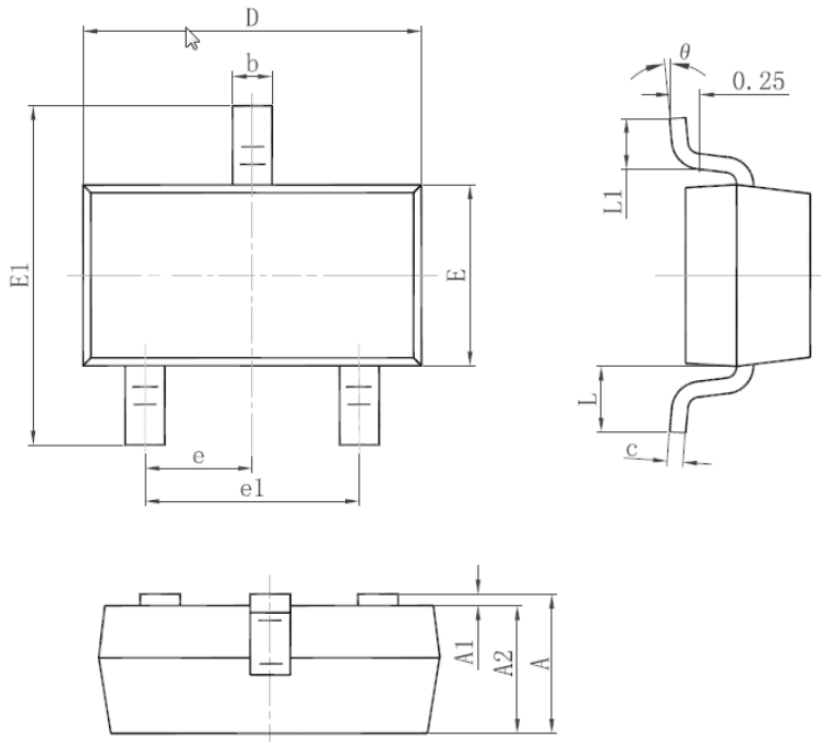
SOT-23 Package Outline Drawing

SYM	DIMENSIONS					
	MILLIMETERS			INCHES		
	MIN	NOM	MAX	MIN	NOM	MAX
A	0.90	--	1.15	0.035	--	0.045
A1	0.00	--	0.14	0.000	--	0.006
A2	0.90	--	1.05	0.035	--	0.041
b	0.30	--	0.50	0.012	--	0.020
c	0.07	--	0.15	0.003	--	0.006
D	2.80	--	3.00	0.110	--	0.118
E	1.20	--	1.40	0.047	--	0.055
E1	2.25	--	2.55	0.089	--	0.100
e	0.95TYP			0.037TYP		
e1	1.80	--	2.00	0.071	--	0.079
L	0.55REF			0.022REF		
L1	0.30	--	0.50	0.012	--	0.020
Θ	0°	--	8°	0°	--	8°

Suggested Land Pattern

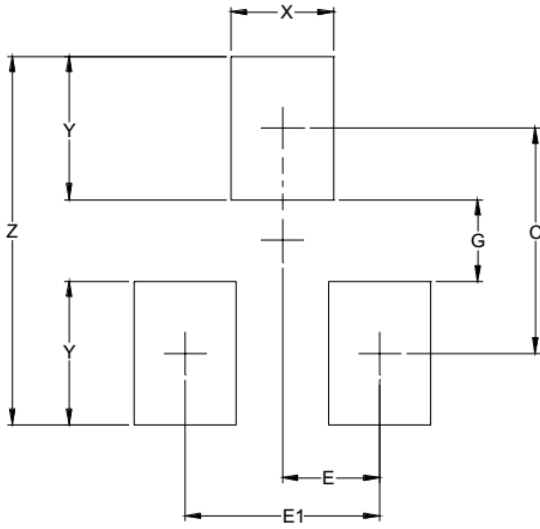

SYM	DIMENSIONS	
	INCHES	MILLIMETERS
C	0.087	2.20
E	0.037	0.95
E1	0.075	1.90
G	0.031	0.80
X	0.039	1.00
Y	0.055	1.40
Z	0.141	3.60

Contact Information

Applied Power Microelectronics Inc.

Website: <http://www.appliedpowermicro.com>

Email: sales@appliedpowermicro.com

Phone: +86 (0519) 8399 3606