

### Description

The AR3341P1S is a bi-directional TVS diode, utilizing leading monolithic silicon technology to provide fast response time and low ESD clamping voltage, making this device an ideal solution for protecting voltage sensitive high-speed data lines. The AR3341P1S has a low capacitance with a typical value at 1.5pF, and complies with the IEC 61000-4-2 (ESD) with  $\pm 30\text{kV}$  air and  $\pm 30\text{kV}$  contact discharge. It is assembled into an ultra-small 1.0x0.6x0.5mm lead-free DFN package. The small size, low capacitance and high ESD surge protection make AR3341P1S an ideal choice to protect cell phone, digital video interfaces and other high speed ports.

### Features

- low capacitance: 1.5pF typical
- low leakage: nA level
- Operating voltage: 3.3V
- Low clamping voltage
- Complies with following standards:
  - IEC 61000-4-2 (ESD) immunity test
    - Air discharge:  $\pm 30\text{kV}$
    - Contact discharge:  $\pm 30\text{kV}$
  - IEC61000-4-5 (Lightning) 26A (8/20 $\mu\text{s}$ )
- RoHS Compliant

### Mechanical Characteristics

- Package: DFN1006-2
- Case Material: “Green” Molding Compound.
- Terminal Connections: See Diagram Below
- Marking Information: See Below

### Applications

- Cellular Handsets and Accessories
- Display Ports
- MDDI Ports
- USB Ports
- Digital Visual Interface (DVI)
- PCI Express and Serial SATA Ports



Caution:

This Device is designed for signal line protection only.

Not intended to be used under bias, not for application with a power line.

### Marking Information

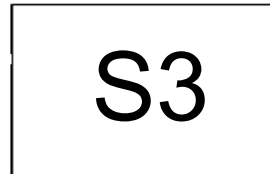

Device Marking Code = S3

### Dimensions and Pin Configuration

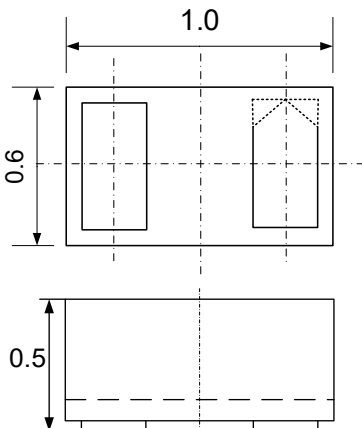

Package Dimensions

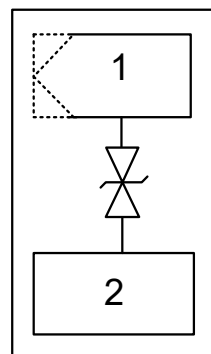

Circuit and Pin Schematic

### Ordering Information

Part Number	Packaging	Reel Size
AR3341P1S	10000/Tape & Reel	7 inch

**Absolute Maximum Ratings (T<sub>A</sub>=25°C unless otherwise specified)**

Parameter	Symbol	Value	Unit
Peak Pulse Power (8/20μs)	Ppk	260	W
Peak Pulse Current (8/20μs)	I <sub>PP</sub>	26	A
ESD per IEC 61000-4-2 (Air) ESD per IEC 61000-4-2 (Contact)	V <sub>ESD</sub>	±30 ±30	kV
Operating Temperature Range	T <sub>J</sub>	-55 to +125	°C
Storage Temperature Range	T <sub>stg</sub>	-55 to +150	°C

**Electrical Characteristics (T<sub>A</sub>=25°C unless otherwise specified)**

Parameter	Symbol	Min	Typ	Max	Unit	Test Condition
Reverse Working Voltage	V <sub>RWM</sub>			3.3	V	
Punch-Through Voltage	V <sub>PT</sub>	3.8			V	I <sub>T</sub> = 2μA
Reverse Leakage Current	I <sub>R</sub>			0.5	μA	V <sub>RWM</sub> = 3.3V
Clamping Voltage	V <sub>C</sub>			5	V	I <sub>PP</sub> = 10A (8 x 20μs pulse)
Clamping Voltage	V <sub>C</sub>			10	V	I <sub>PP</sub> = 26A (8 x 20μs pulse)
Junction Capacitance	C <sub>J</sub>		1.5		pF	V <sub>R</sub> = 0V, f = 1MHz

**Typical Performance Characteristics (TA=25°C unless otherwise Specified)**

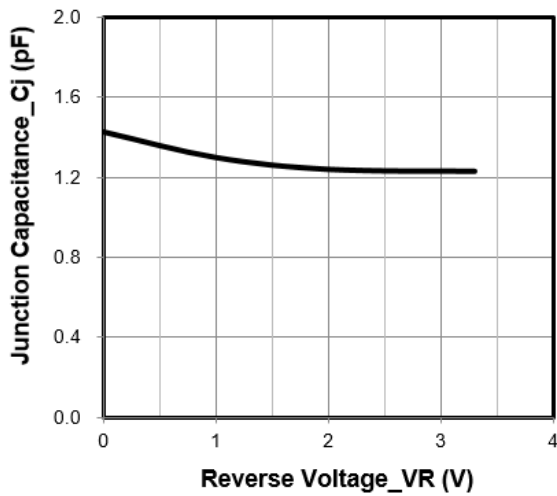

**Junction Capacitance vs. Reverse Voltage**

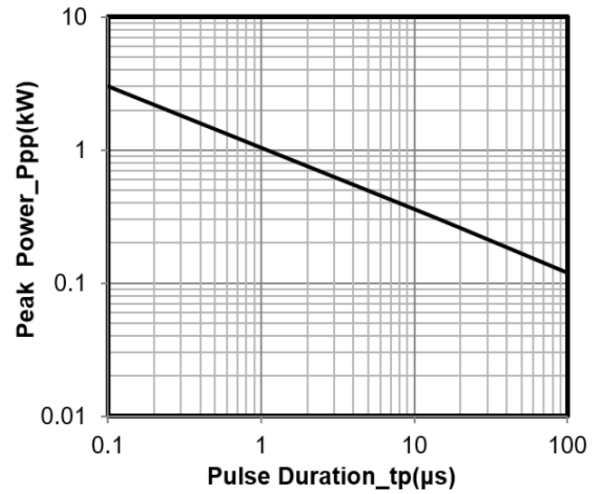

**Peak Pulse Power vs. Pulse Time**

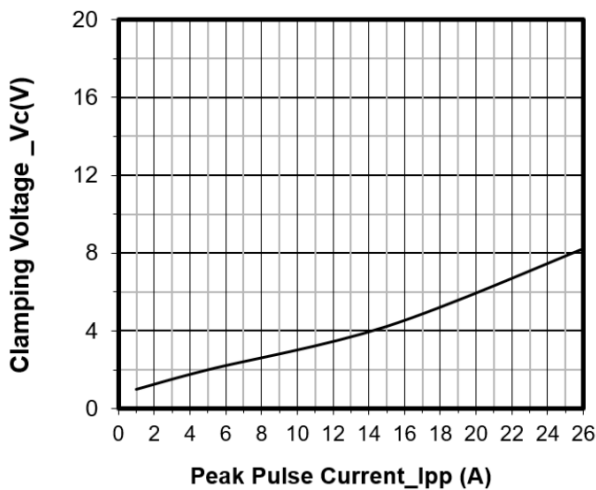

**Clamping Voltage vs. Peak Pulse Current**

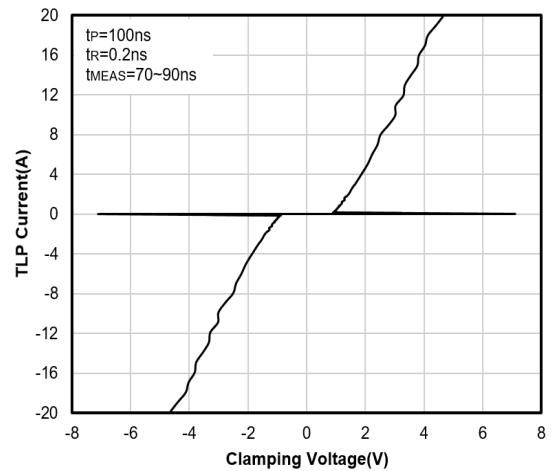

**TLP Curve**

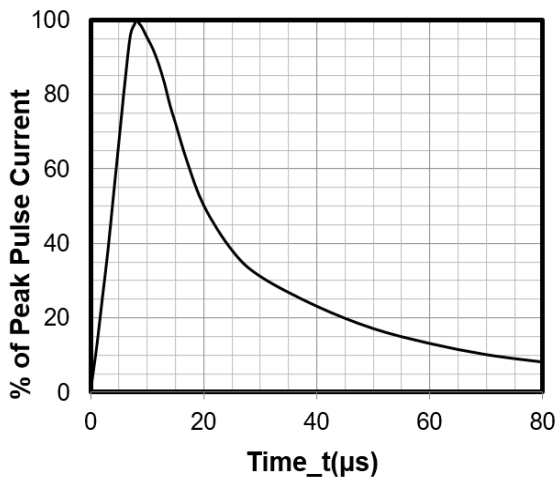

**8 X 20μs Pulse Waveform**

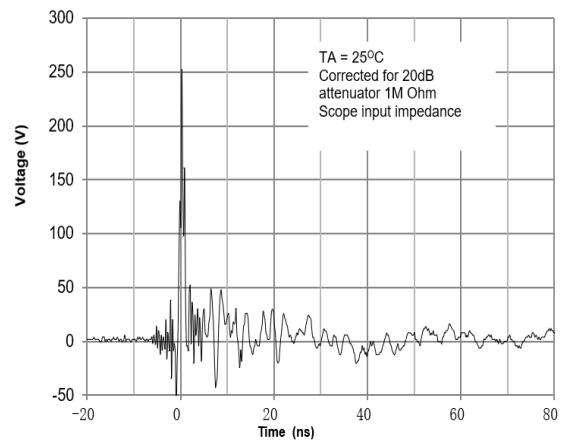

**ESD Clamping Voltage  
8 kV Contact per IEC61000-4-2**

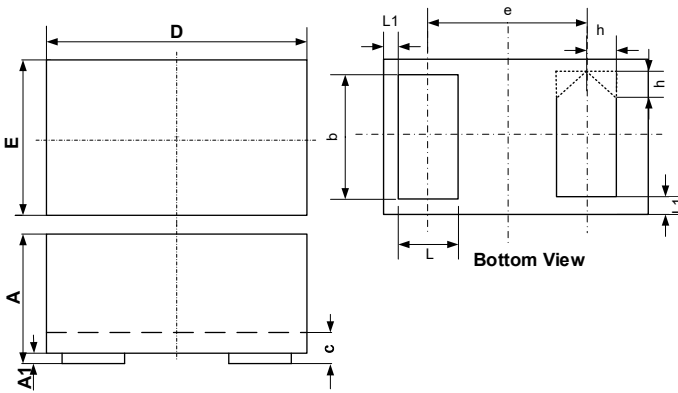
**DFN1006-2 Package Outline Drawing**

SYM	DIMENSIONS					
	MILLIMETERS			INCHES		
	MIN	NOM	MAX	MIN	NOM	MAX
A	0.40	0.50	0.55	0.016	0.020	0.022
A1	0.00	0.02	0.05	0.000	0.001	0.002
b	0.45	0.50	0.55	0.018	0.020	0.022
c	0.12	0.15	0.18	0.005	0.006	0.007
D	0.95	1.00	1.05	0.037	0.039	0.041
e	0.65 BSC			0.026 BSC		
E	0.55	0.60	0.65	0.022	0.024	0.026
L	0.20	0.25	0.30	0.008	0.010	0.012
L1	0.05REF			0.002REF		
h	0.07	0.12	0.17	0.003	0.005	0.007

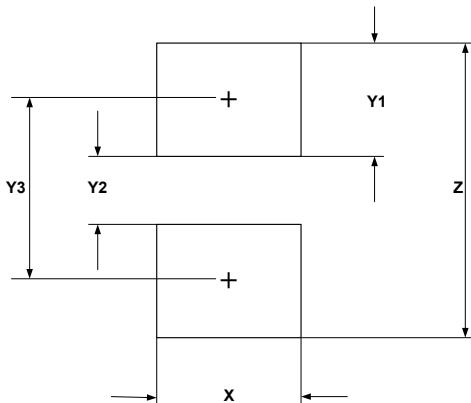
**Suggested Land Pattern**

SYM	DIMENSIONS	
	MILLIMETERS	INCHES
X	0.60	0.024
Y1	0.50	0.020
Y2	0.30	0.012
Y3	0.80	0.032
Z	1.30	0.052

**Contact Information**

Applied Power Microelectronics Inc.

 Website: <http://www.appliedpowermicro.com>

 Email: [sales@appliedpowermicro.com](mailto:sales@appliedpowermicro.com)

Phone: +86 (0519) 8399 3606