

Description

The AR3321D3 is a bi-directional TVS diode, utilizing leading monolithic silicon technology to provide fast response time and low ESD clamping voltage, making this device an ideal solution for protecting voltage sensitive high-speed data lines. The AR3321D3 has an ultra-low capacitance with a typical value at 1.5pF, and complies with the IEC 61000-4-2 (ESD) with $\pm 30\text{kV}$ air and $\pm 30\text{kV}$ contact discharge. It is assembled into a SOD-323 lead-free package. The small size, ultra-low capacitance and high ESD surge protection make AR3321D3 an ideal choice to protect cell phone, digital video interfaces and other high speed ports.

Features

- Ultra low capacitance: 1.5pF typical
- Ultra low leakage: nA level
- Operating voltage: 3.3V
- Low clamping voltage
- Complies with following standards:
 - IEC 61000-4-2 (ESD) immunity test
 - Air discharge: $\pm 30\text{kV}$
 - Contact discharge: $\pm 30\text{kV}$
 - IEC61000-4-5 (Lightning) 26A (8/20 μs)
- RoHS Compliant

Mechanical Characteristics

- Package: SOD-323
- Lead Finish: Matte Tin
- Case Material: “Green” Molding Compound.
- Terminal Connections: See Diagram Below
- Marking Information: See Below

Applications

- Cellular Handsets and Accessories
- Display Ports
- MDDI Ports
- USB Ports
- Digital Visual Interface (DVI)
- PCI Express and Serial SATA Ports



Caution:

This Device is designed for signal line protection only.

Not intended to be used under bias, not for application with a power line.

Marking Information



CC = Device Marking Code

Equivalent Circuit and Pin Configuration

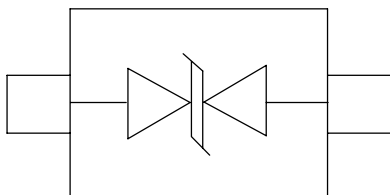

Circuit and Pin Schematic

Ordering Information

Part Number	Packaging	Reel Size
AR3321D3	3000/Tape & Reel	7 inch

Absolute Maximum Ratings (T_A=25°C unless otherwise specified)

Parameter	Symbol	Value	Unit
Peak Pulse Power (8/20μs)	Ppk	312	W
Peak Pulse Current (8/20μs)	I _{PP}	26	A
ESD per IEC 61000-4-2 (Air)	V _{ESD}	±30	kV
ESD per IEC 61000-4-2 (Contact)		±30	
Operating Temperature Range	T _J	-55 to +125	°C
Storage Temperature Range	T _{stg}	-55 to +150	°C

Electrical Characteristics (T_A=25°C unless otherwise specified)

Parameter	Symbol	Min	Typ	Max	Unit	Test Condition
Reverse Working Voltage	V _{RWM}			3.3	V	
Breakdown Voltage	V _{BR}	3.5			V	I _T = 2μA
Reverse Leakage Current	I _R			1	μA	V _{RWM} = 3.3V
Clamping Voltage	V _C			5	V	I _{PP} = 1A (8 x 20μs pulse)
Clamping Voltage	V _C			12	V	I _{PP} = 26A (8 x 20μs pulse)
Junction Capacitance	C _J		1.5		pF	V _R = 0V, f = 1MHz

Typical Performance Characteristics (TA=25°C unless otherwise Specified)

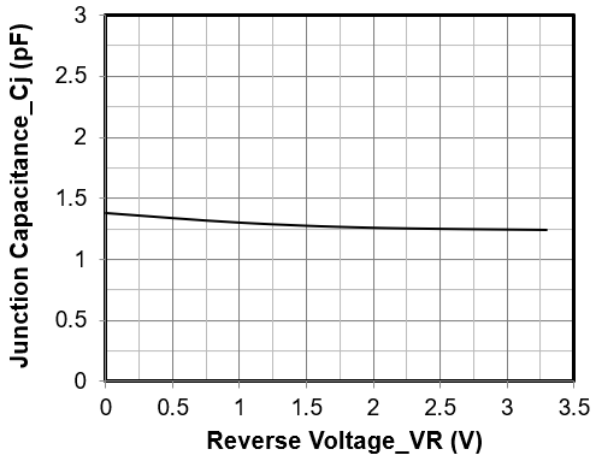

Junction Capacitance vs. Reverse Voltage

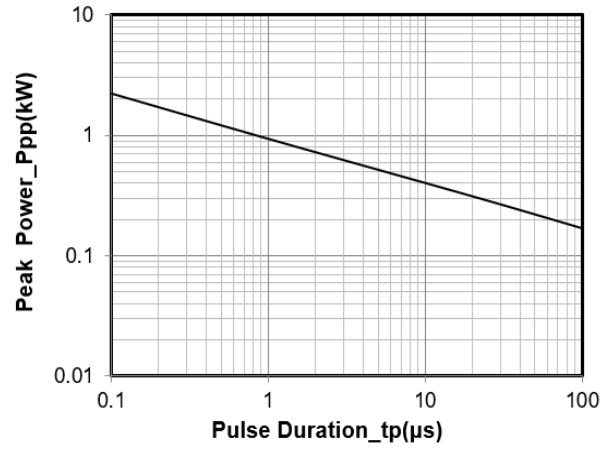

Peak Pulse Power vs. Pulse Time

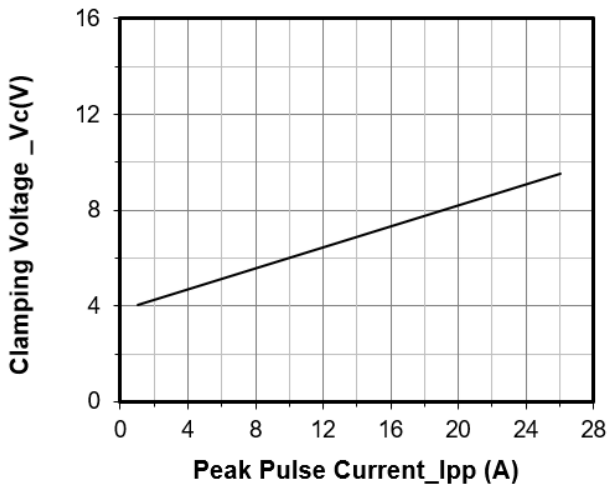

Clamping Voltage vs. Peak Pulse Current (tp = 8/20µs)

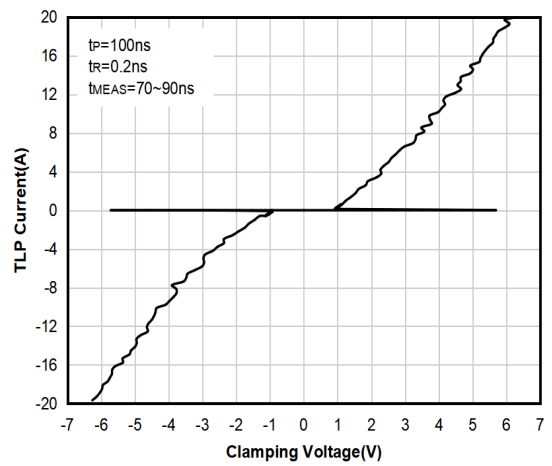

TLP Measurement

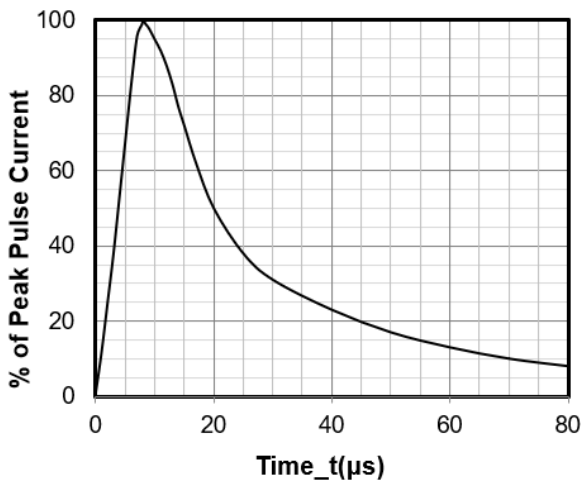

8 X 20µs Pulse Waveform

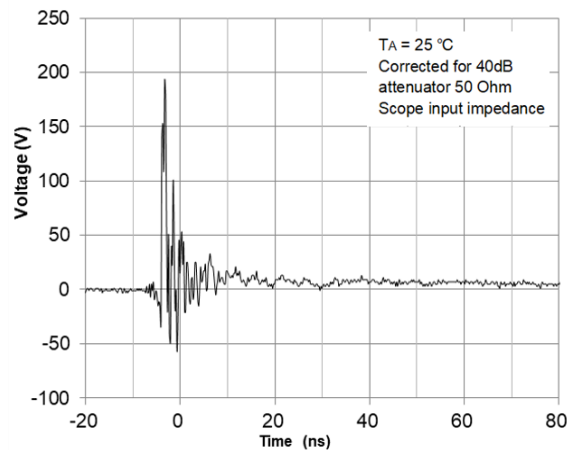

ESD Clamping Voltage
8 kV Contact per IEC61000-4-2

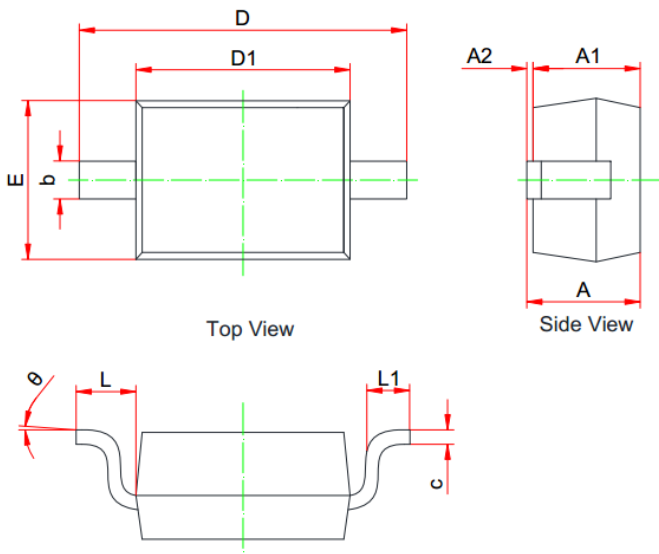
SOD-323 Package Outline Drawing

SYM	MILLIMETERS		
	MIN	NOM	MAX
A	0.800	--	1.100
A1	0.800	--	0.900
A2	0.000	--	0.100
b	0.250	--	0.400
c	0.080	--	0.177
D1	1.600	1.700	1.800
D	2.300	--	2.800
E	1.150	--	1.400
L	0.475REF		
L1	0.100	--	0.500
θ	0°	--	8°

Suggested Land Pattern

Unit: mm
Contact Information

Applied Power Microelectronics Inc.

 Website: <http://www.appliedpowermicro.com>

 Email: sales@appliedpowermicro.com

Phone: +86 (0519) 8399 3606