

Description

The AR3304P5J is an ultra low capacitance TVS array, utilizing leading monolithic silicon technology to provide fast response time and low ESD clamping voltage, making this device an ideal solution for protecting voltage sensitive high-speed data lines. The AR3304P5J complies with the IEC 61000-4-2 (ESD) with $\pm 25\text{kV}$ air and $\pm 20\text{kV}$ contact discharge. It is assembled into a 10-pin 2.5x1.0x0.5mm lead-free DFN package. The flow through style package allows for easy PCB layout and matched trace lengths necessary to maintain consistent impedance between high speed differential lines such as USB 3.1 and HDMI. The small size, ultra-low capacitance and high ESD surge protection make AR3304P5J an ideal choice to protect HDMI, MDDI, USB 3.0, USB3.1 and other high speed ports.

Features

- Ultra low capacitance: 0.4pF typical (I/O to I/O)
- Ultra low leakage: nA level
- Operating voltage: 3.3V
- Low clamping voltage
- Up to 4 lines protects
- Complies with following standards:
 - IEC 61000-4-2 (ESD) immunity test
 - Air discharge: $\pm 25\text{kV}$
 - Contact discharge: $\pm 20\text{kV}$
 - IEC61000-4-5 (Lightning) 6A (8/20 μs)
- RoHS Compliant

Dimensions and Pin Configuration

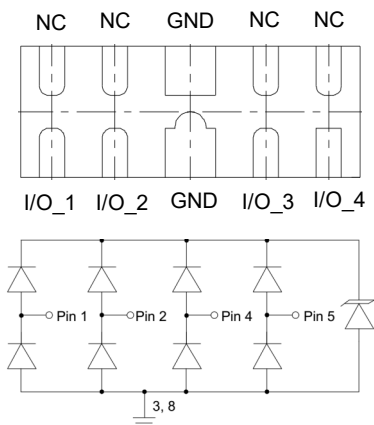

Circuit and Pin Schematic

Mechanical Characteristics

- Package: DFN2510-10 (2.5x1.0x0.5mm)
- Lead Finish: Matte Tin
- Case Material: "Green" Molding Compound.
- Terminal Connections: See Diagram Below
- Marking Information: See Below

Applications

- HDMI 1.3 & 1.4 & 2.0, USB 2.0&3.0&3.1, and MDDI ports
- Monitors and flat panel displays
- Set-top box and Digital TV
- Video graphics cards
- Digital Visual Interface (DVI)
- Notebook Computers
- PCI Express and Serial SATA Ports

Marking Information

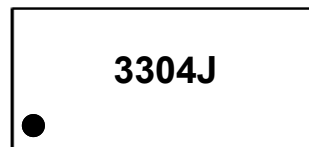

3304J = Device Marking Code
 Dot denotes Pin1

Ordering Information

Part Number	Packaging	Reel Size
AR3304P5J	3000/Tape & Reel	7 inch

Absolute Maximum Ratings ($T_A=25^\circ\text{C}$ unless otherwise specified)

Parameter	Symbol	Value	Unit
Peak Pulse Power (8/20 μs)	Ppk	60	W
Peak Pulse Current (8/20 μs)	I _{PP}	6	A
ESD per IEC 61000-4-2 (Air)	V _{ESD}	± 25	kV
ESD per IEC 61000-4-2 (Contact)		± 20	
Operating Temperature Range	T _J	-55 to +125	$^\circ\text{C}$
Storage Temperature Range	T _{stg}	-55 to +150	$^\circ\text{C}$

Electrical Characteristics ($T_A=25^\circ\text{C}$ unless otherwise specified)

Parameter	Symbol	Min	Typ	Max	Unit	Test Condition
Reverse Working Voltage	V _{RWM}			3.3	V	Any I/O pin to ground
Breakdown Voltage	V _{BR}	3.5			V	I _T = 1mA, any I/O pin to ground
Reverse Leakage Current	I _R			0.2	μA	V _{RWM} = 3.3V, any I/O pin to ground
Clamping Voltage	V _C			7	V	I _{PP} = 1A (8 x 20 μs pulse), any I/O pin to ground
Clamping Voltage	V _C			10	V	I _{PP} = 6A (8 x 20 μs pulse), any I/O pin to ground
Junction Capacitance	C _J		0.4		pF	V _R = 0V, f = 1MHz, between I/O pins
Junction Capacitance	C _J		0.6		pF	V _R = 0V, f = 1MHz, any I/O pin to ground

Typical Performance Characteristics ($T_A=25^\circ\text{C}$ unless otherwise Specified)

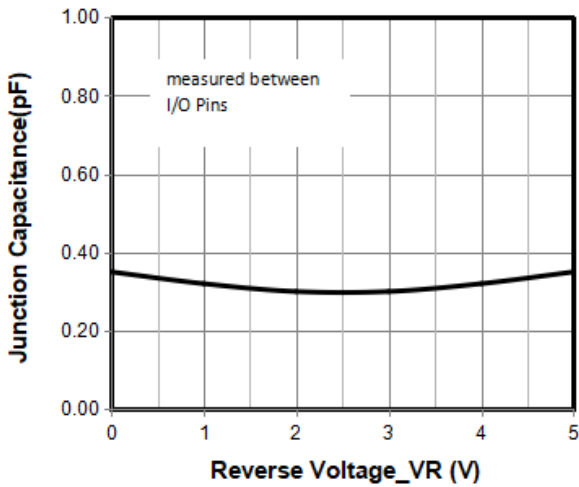

Junction Capacitance vs. Reverse Voltage

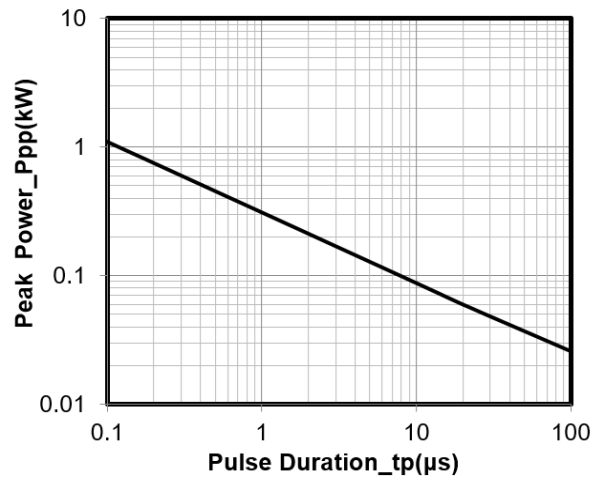

Peak Pulse Power vs. Pulse Time

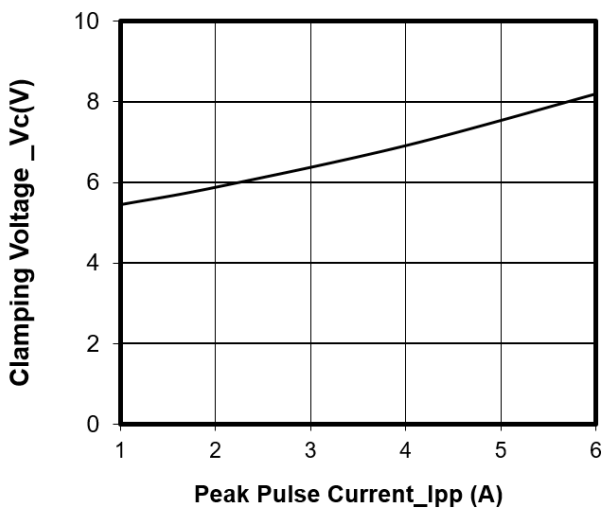

Clamping Voltage vs. Peak Pulse Current

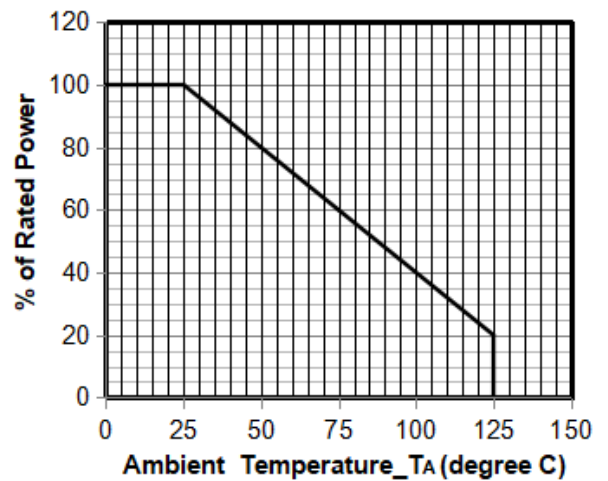

Power Derating Curve

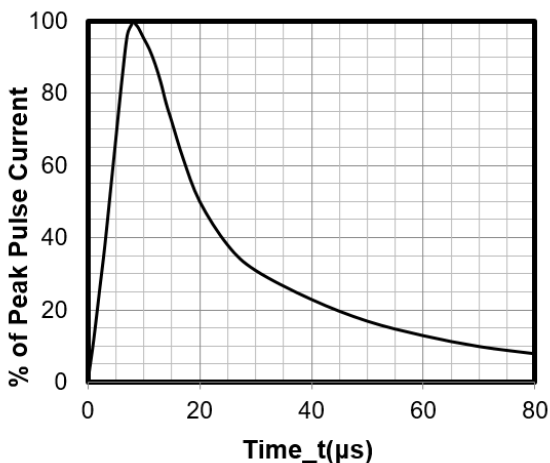

8 X 20μs Pulse Waveform

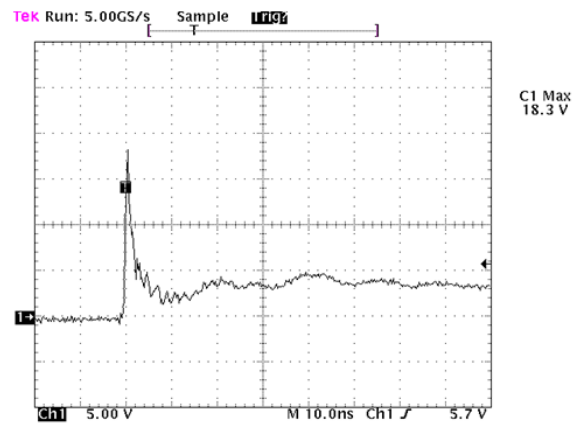

Note: Data is taken with a 10x attenuator
ESD Clamping Voltage
8 kV Contact per IEC61000-4-2

DFN2510-10 Package Outline Drawing

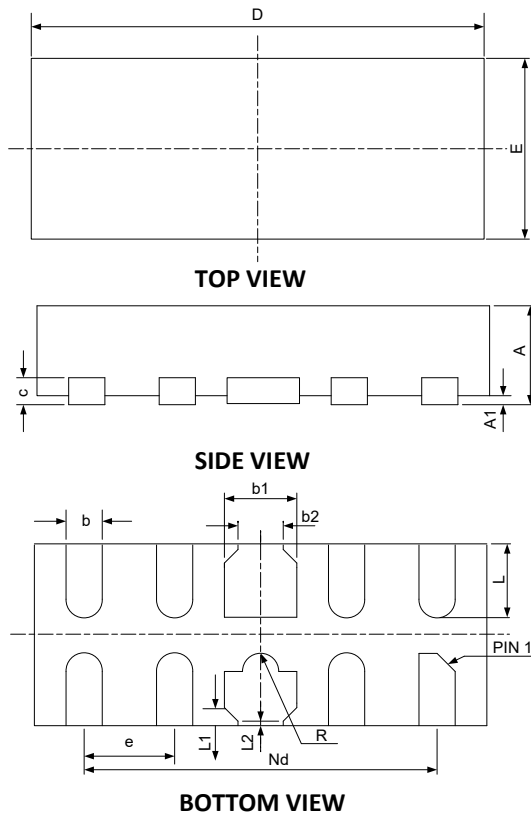

SYM	DIMENSIONS					
	MILLIMETERS			INCHES		
	MIN	NOM	MAX	MIN	NOM	MAX
A	0.45	0.50	0.55	0.018	0.020	0.022
A1	0.00	0.02	0.05	0.000	0.001	0.002
b	0.15	0.20	0.25	0.006	0.008	0.010
b1	0.35	0.40	0.45	0.014	0.016	0.018
b2	0.20	0.25	0.30	0.008	0.010	0.012
c	0.10	0.15	0.20	0.004	0.006	0.008
D	2.45	2.50	2.55	0.098	0.100	0.102
e	0.50BSC			0.020BSC		
Nd	2.00BSC			0.080BSC		
E	0.95	1.00	1.05	0.038	0.040	0.042
L	0.35	0.40	0.45	0.014	0.016	0.018
L1	0.075REF			0.003REF		
L2	0.050REF			0.002REF		
h	0.08	0.12	0.15	0.003	0.005	0.006
R	0.05	0.10	0.15	0.002	0.004	0.006

Suggested Land Pattern

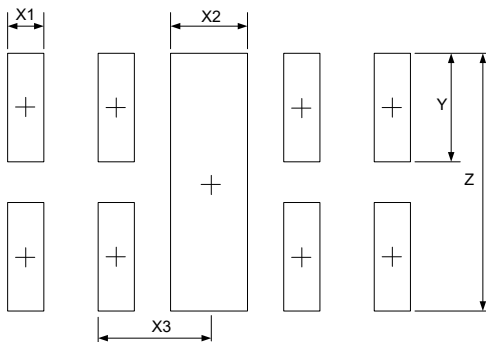

SYM	DIMENSIONS	
	MILLIMETERS	INCHES
X1	0.200	0.008
X2	0.400	0.016
X3	0.500	0.020
Y	0.600	0.024
Z	1.400	0.056

Contact Information

Applied Power Microelectronics Inc.
 Website: <http://www.appliedpowermicro.com>
 Email: sales@appliedpowermicro.com
 Phone: +86 (0519) 8399 3606