

Description

The AR0562PN is an Bi-directional TVS diode, utilizing leading monolithic silicon technology to provide fast response time and low ESD clamping voltage, making this device an ideal solution for protecting voltage sensitive high-speed data lines. The AR0562PN has an ultra-low capacitance with a typical value at 0.25pF, and complies with the IEC 61000-4-2 (ESD) with $\pm 15\text{kV}$ air and $\pm 8\text{kV}$ contact discharge. The small size, ultra-low capacitance and high ESD surge protection make AR0562PN an ideal choice to protect cell phone, digital visual interfaces and other high speed ports.

Features

- Ultra low capacitance: 0.25pF typical (I/O to I/O)
- Ultra low leakage: nA level
- Low operating voltage: 5.5/6.5V
- Low clamping voltage
- 6-pin leadless package
- Protects two I/O lines and a power line
- Complies with following standards:
 - IEC 61000-4-2 (ESD) immunity test
Air discharge: $\pm 15\text{kV}$
Contact discharge: $\pm 8\text{kV}$
 - IEC61000-4-5 (Lightning) 3A (8/20 μs)
- RoHS Compliant

Mechanical Characteristics

- Package: DFN1210-6
- Case Material: “Green” Molding Compound.
- Terminal Connections: See Diagram Below
- Marking Information: See Below

Applications

- Cellular Handsets and Accessories
- USB Ports
- Digital Visual Interface
- MMC/SD Ports

Marking Information



53N = Device Marking Code

Equivalent Circuit and Pin Configuration

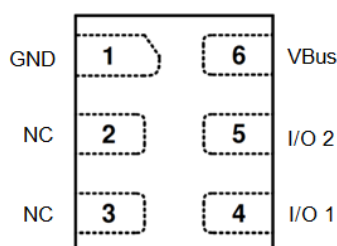
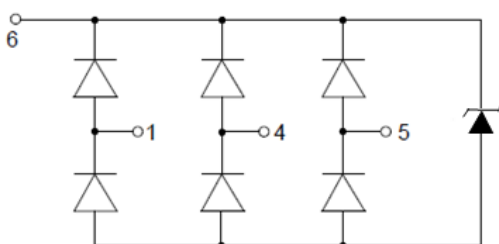

Circuit and Pin Schematic

Ordering Information

Part Number	Packaging	Reel Size
AR0562PN	3,000/Tape & Reel	7 inch

Absolute Maximum Ratings ($T_A=25^{\circ}\text{C}$ unless otherwise specified)

Parameter	Symbol	Value	Unit
Peak Pulse Power (8/20 μs)	Ppk	51	W
Peak Pulse Current (8/20 μs)	I _{PP}	3	A
ESD per IEC 61000-4-2 (Air) ESD per IEC 61000-4-2 (Contact)	V _{ESD}	± 15 ± 8	kV
Operating Temperature Range	T _J	-55 to +125	$^{\circ}\text{C}$
Storage Temperature Range	T _{stg}	-55 to +150	$^{\circ}\text{C}$

Electrical Characteristics ($T_A=25^{\circ}\text{C}$ unless otherwise specified)

Parameter	Symbol	Min	Typ	Max	Unit	Test Condition
Reverse Working Voltage	V _{RWM}			6.5	V	Pin 6 to GND
Breakdown Voltage	V _{BR}	7		12	V	I _T = 1mA, Pin 6 to GND
Reverse Leakage Current	I _R			0.5	μA	V _{RWM} = 6.5V, Pin 6 to GND
Clamping Voltage	V _C			12	V	I _{PP} = 1A (8 x 20 μs pulse), any I/O pin to ground
Clamping Voltage	V _C			17	V	I _{PP} = 3A (8 x 20 μs pulse), any I/O pin to ground
Junction Capacitance	C _J		0.5		pF	V _R = 0V, f = 1MHz, any I/O pin to ground
Junction Capacitance	C _J		0.25	0.5	pF	V _R = 0V, f = 1MHz, between I/O pins

Typical Performance Characteristics (TA=25°C unless otherwise Specified)

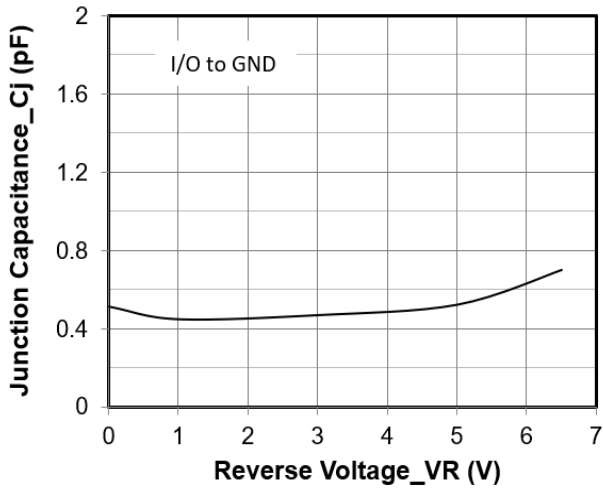

Junction Capacitance vs. Reverse Voltage

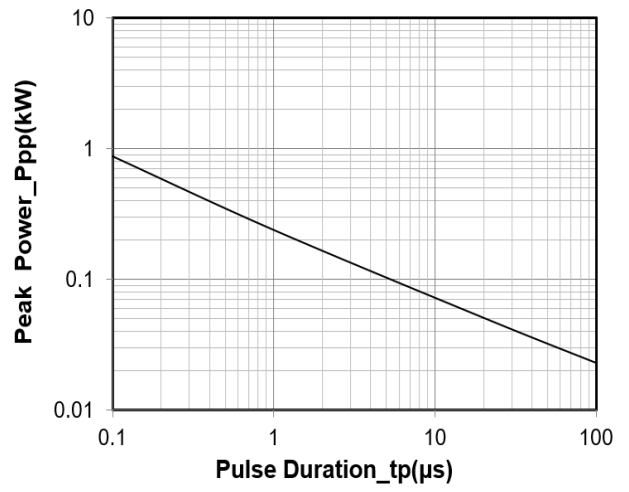

Peak Pulse Power vs. Pulse Time

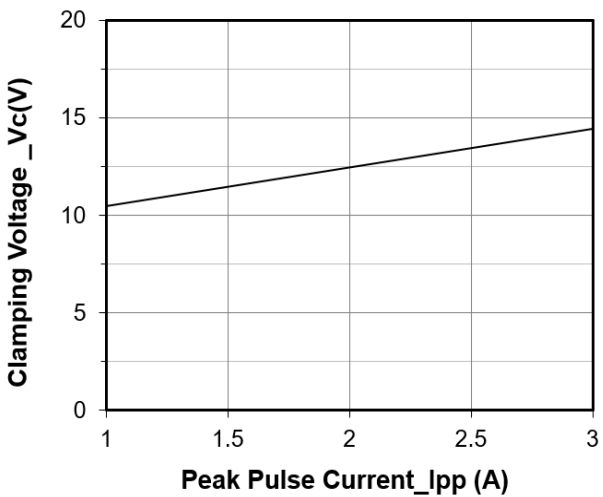

Clamping Voltage vs. Peak Pulse Current

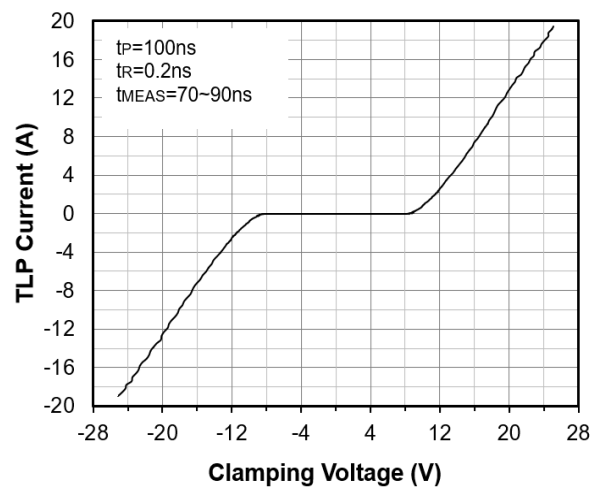

TLP Measurement

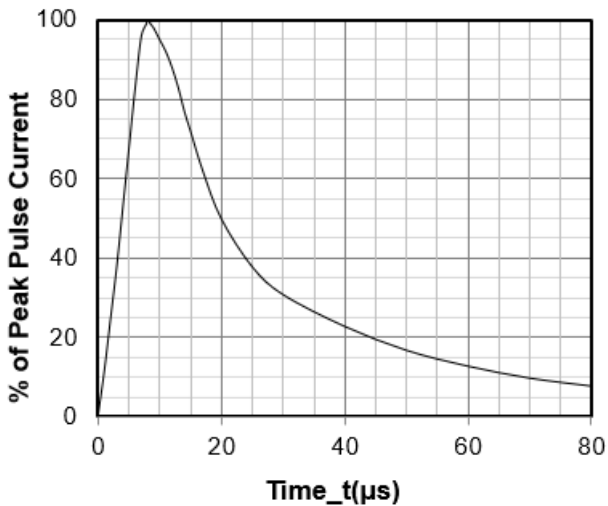

8 X 20μs Pulse Waveform

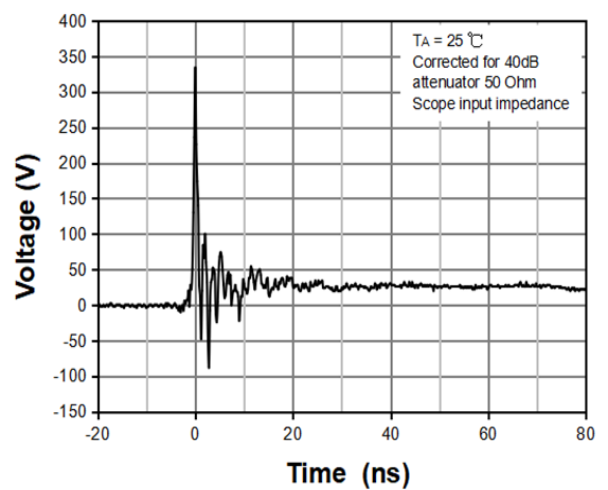

ESD Clamping Voltage
8 kV Contact per IEC61000-4-2

DFN1210-6 Package Outline Drawing

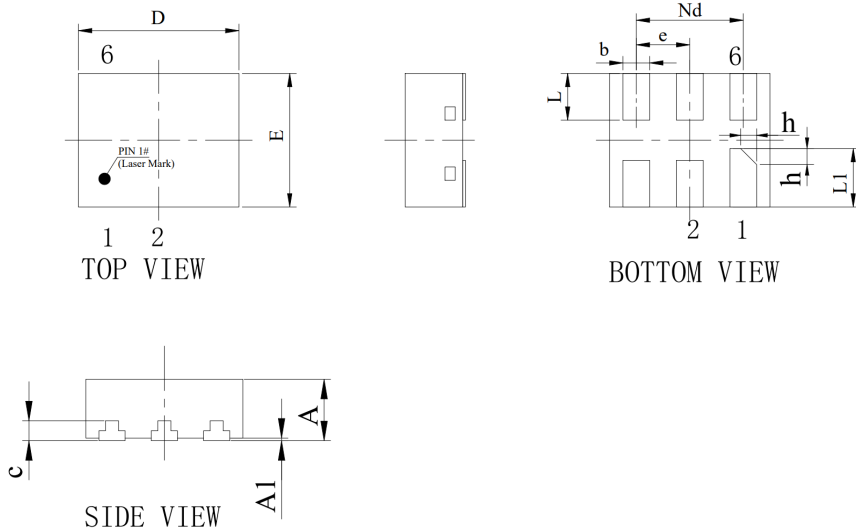

SYM	DIMENSIONS		
	MILLIMETERS		
	MIN	NOM	MAX
A	0.40	0.45	0.50
A1	0	0.02	0.05
b	0.15	0.20	0.25
c	0.152REF		
D	1.15	1.20	1.25
e	0.40BSC		
Nd	0.80BSC		
E	0.95	1.00	1.05
L	0.25	0.35	0.45
L1	0.338	0.438	0.538
h	0.07	0.12	0.17

Suggested Land Pattern

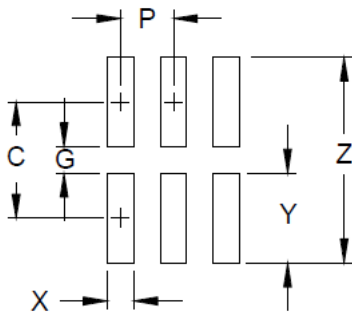

SYM	DIMENSIONS	
	MILLIMETERS	INCHES
C	0.875	0.034
G	0.20	0.008
P	0.40	0.016
X	0.20	0.008
Y	0.675	0.027
Z	1.55	0.061

Contact Information

Applied Power Microelectronics Inc.
 Website: <http://www.appliedpowermicro.com>
 Email: sales@appliedpowermicro.com
 Phone: +86 (0519) 8399 3606