

Description

The AR0521P0SC is a bi-directional TVS diode, utilizing leading monolithic silicon technology to provide fast response time and low ESD clamping voltage, making this device an ideal solution for protecting voltage sensitive high-speed data lines. The AR0521P0SC has a low capacitance with a typical value at 0.3pF, and complies with the IEC 61000-4-2 (ESD) with $\pm 15\text{kV}$ air and $\pm 15\text{kV}$ contact discharge. The small size, low capacitance and high ESD surge protection make AR0521P0SC an ideal choice to protect cell phone, digital visual interfaces, HDMI, DVI, USB2.0, USB3.0, and other high speed ports.

Features

- low capacitance: 0.3pF typical
- Ultra low leakage: nA level
- Operating voltage: 5V
- Low clamping voltage
- 2-pin leadless package
- Complies with following standards:
 - IEC 61000-4-2 (ESD) immunity test
 - Air discharge: $\pm 15\text{kV}$
 - Contact discharge: $\pm 15\text{kV}$
 - IEC61000-4-5 (Lightning) 5A (8/20 μs)
- RoHS Compliant

Mechanical Characteristics

- Package: DFN0603-2
- Case Material: “Green” Molding Compound.
- Terminal Connections: See Diagram Below
- Marking Information: See Below

Applications

- Cellular Handsets and Accessories
- Display Ports
- MDDI / MHL
- USB 2.0 / USB 3.0
- Digital Visual Interface (DVI)
- PCI Express and Serial SATA Ports

Caution:



This Device is designed for signal line protection only.

Not intended to be used under bias, not for application with a power line.

Marking Information



2R = Device Marking Code

Equivalent Circuit and Pin Configuration

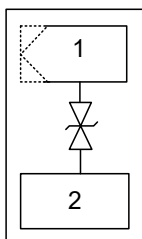

Circuit and Pin Schematic

Ordering Information

Part Number	Packaging	Reel Size
AR0521P0SC	10000/Tape & Reel	7 inch

Absolute Maximum Ratings (T_A=25°C unless otherwise specified)

Parameter	Symbol	Value	Unit
Peak Pulse Power (8/20μs)	Ppk	35	W
Peak Pulse Current (8/20μs)	I _{PP}	5	A
ESD per IEC 61000-4-2 (Air)	V _{ESD}	±15	kV
ESD per IEC 61000-4-2 (Contact)		±15	
Operating Temperature Range	T _J	-55 to +125	°C
Storage Temperature Range	T _{stg}	-55 to +150	°C

Electrical Characteristics (T_A=25°C unless otherwise specified)

Parameter	Symbol	Min	Typ	Max	Unit	Test Condition
Reverse Working Voltage	V _{RWM}			5	V	
Breakdown Voltage	V _{BR}	6			V	I _T = 1mA
Reverse Leakage Current	I _R			0.2	μA	V _{RWM} = 5V
Clamping Voltage	V _C			7	V	I _{PP} = 5A (8 x 20μs pulse)
ESD Clamping Voltage ⁽¹⁾	V _C		4.6		V	I _{PP} = 4A, t _p = 0.2/100ns (TLP)
			9.1		V	I _{PP} = 16A, t _p = 0.2/100ns (TLP)
Dynamic Resistance ⁽²⁾	R _{DYN}		0.38		Ohm	t _p = 0.2/100ns (TLP)
Junction Capacitance	C _J		0.3		pF	V _R = 0V, f = 1MHz

(1) Transmission Line Pulse Test (TLP) Settings: t_p = 100ns, t_r = 0.2ns.

(2) Dynamic resistance calculated from I_{TLP} = 4A to I_{TLP} = 16A.

Typical Performance Characteristics (T_A=25°C unless otherwise Specified)

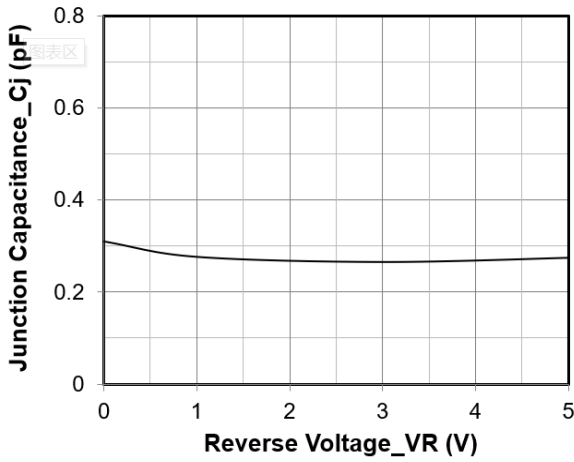

Junction Capacitance vs. Reverse Voltage

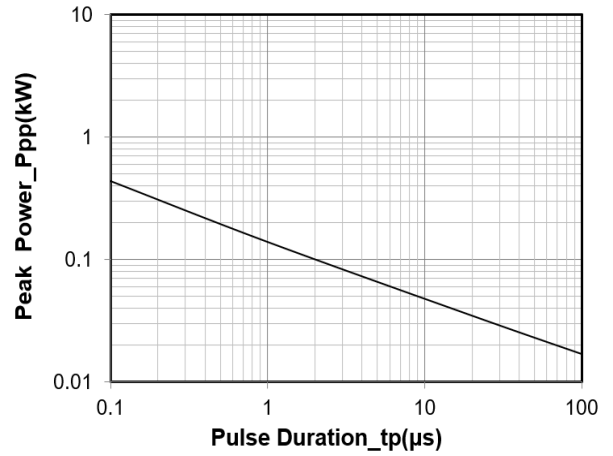

Peak Pulse Power vs. Pulse Time

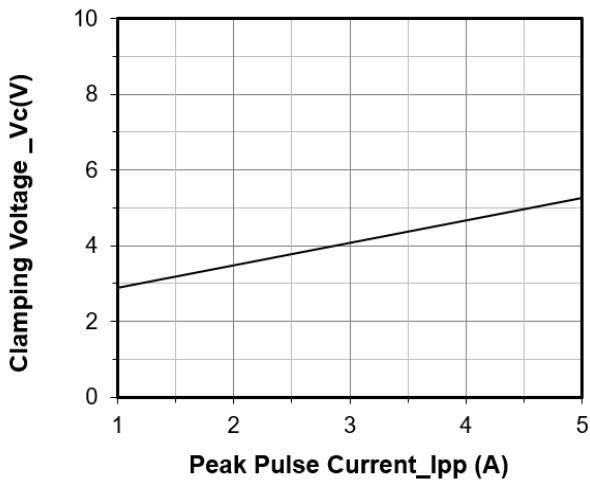

Clamping Voltage vs. Peak Pulse Current (tp = 8/20μs)

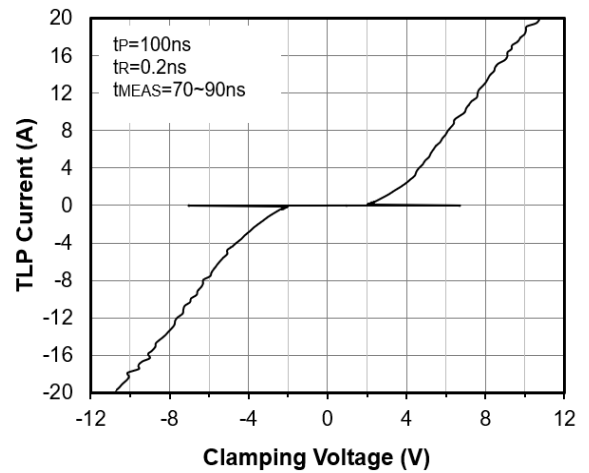

TLP Measurement

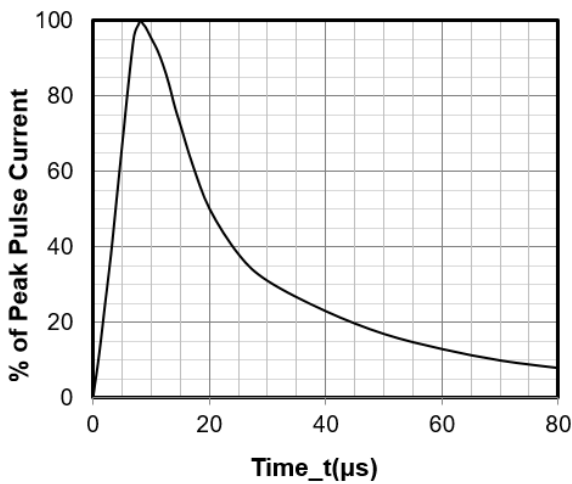

8 X 20μs Pulse Waveform

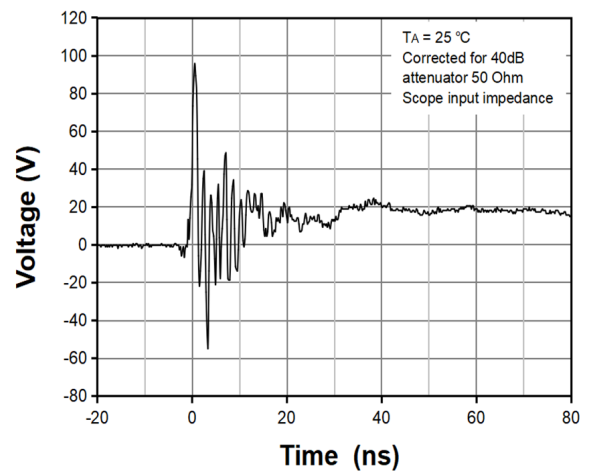

ESD Clamping Voltage

8 kV Contact per IEC61000-4-2

DFN0603-2 Package Outline Drawing

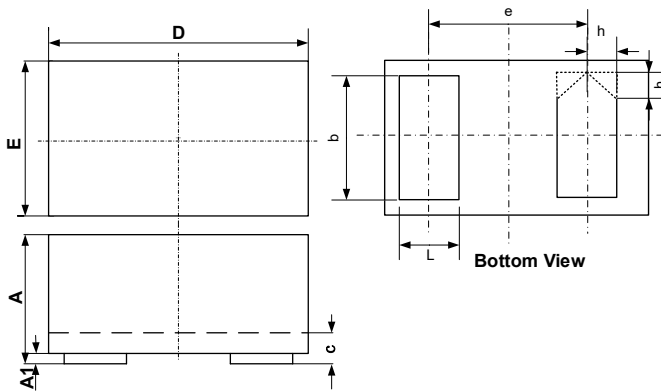

SYM	DIMENSIONS		
	MILLIMETERS		
	MIN	NOM	MAX
A	0.230		0.340
A1	0.000	-	0.050
b	0.200	-	0.300
c	0.050	-	0.180
D	0.550	-	0.650
e	0.360 BSC		
E	0.250	-	0.350
L	0.130	-	0.240
h	0.079 BSC		

Suggested Land Pattern

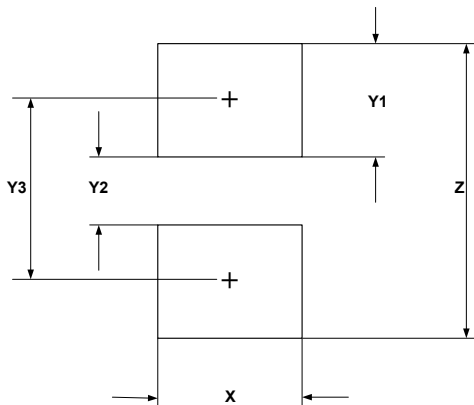

SYM	DIMENSIONS	
	MILLIMETERS	INCHES
X	0.30	0.012
Y1	0.25	0.010
Y2	0.15	0.006
Y3	0.40	0.016
Z	0.65	0.026

Contact Information

Applied Power Microelectronics Inc.
 Website: <http://www.appliedpowermicro.com>
 Email: sales@appliedpowermicro.com
 Phone: +86 (0519) 8399 3606