

### Description

The AR0511D3 is a 5V bi-directional TVS diode, utilizing leading monolithic silicon technology to provide fast response time and low ESD clamping voltage, making this device an ideal solution for protecting voltage sensitive high-speed data lines. The AR0511D3 has a low capacitance with a typical value at 1pF, and complies with the IEC 61000-4-2 (ESD) with  $\pm 30\text{kV}$  air and  $\pm 30\text{kV}$  contact discharge. It is assembled into a lead-free SOD-323 package. The small size, low capacitance and high ESD surge protection make AR0511D3 an ideal choice to protect cell phone, wireless systems, and communication equipment.

### Features

- 360W peak pulse power (8/20 $\mu\text{s}$ )
- Ultra low capacitance: 1pF typical
- Ultra low leakage: nA level
- Operating voltage: 5V
- Low clamping voltage
- Protects one power line or data line
- Complies with following standards:
  - IEC 61000-4-2 (ESD) immunity test  
     Air discharge:  $\pm 30\text{kV}$   
     Contact discharge:  $\pm 30\text{kV}$
  - IEC61000-4-5 (Lightning) 18A (8/20 $\mu\text{s}$ )
- RoHS Compliant

### Dimensions and Pin Configuration

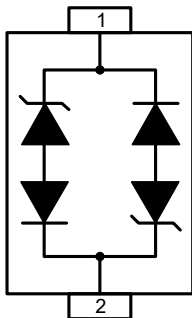

Circuit and Pin Schematic

### Mechanical Characteristics

- Package: SOD-323
- Lead Finish: Matte Tin
- Case Material: “Green” Molding Compound.
- Terminal Connections: See Diagram Below
- Marking Information: See Below

### Applications

- USB Ports
- Smart Phones
- Wireless Systems
- Ethernet 10/100/1000 Base T

### Marking Information

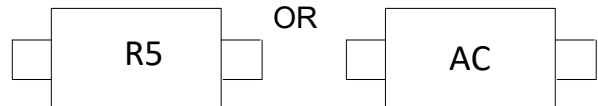

### Ordering Information

Part Number	Packaging	Reel Size
AR0511D3	3000/Tape & Reel	7 inch

**Absolute Maximum Ratings (T<sub>A</sub>=25°C unless otherwise specified)**

Parameter	Symbol	Value	Unit
Peak Pulse Power (8/20μs)	P <sub>pk</sub>	360	W
Peak Pulse Current (8/20μs)	I <sub>PP</sub>	18	A
ESD per IEC 61000-4-2 (Air) ESD per IEC 61000-4-2 (Contact)	V <sub>ESD</sub>	±30 ±30	kV
Operating Temperature Range	T <sub>J</sub>	-55 to +125	°C
Storage Temperature Range	T <sub>stg</sub>	-55 to +150	°C

**Electrical Characteristics (T<sub>A</sub>=25°C unless otherwise specified)**

Parameter	Symbol	Min	Typ	Max	Unit	Test Condition
Reverse Working Voltage	V <sub>RWM</sub>			5	V	
Breakdown Voltage	V <sub>BR</sub>	6			V	I <sub>T</sub> = 1mA
Reverse Leakage Current	I <sub>R</sub>			0.2	μA	V <sub>RWM</sub> = 5V
Clamping Voltage	V <sub>C</sub>			10	V	I <sub>PP</sub> = 1A (8 x 20μs pulse)
Clamping Voltage	V <sub>C</sub>			20	V	I <sub>PP</sub> = 18A (8 x 20μs pulse)
Junction Capacitance	C <sub>J</sub>		1		pF	V <sub>R</sub> = 0V, f = 1MHz

**Typical Performance Characteristics (TA=25°C unless otherwise Specified)**

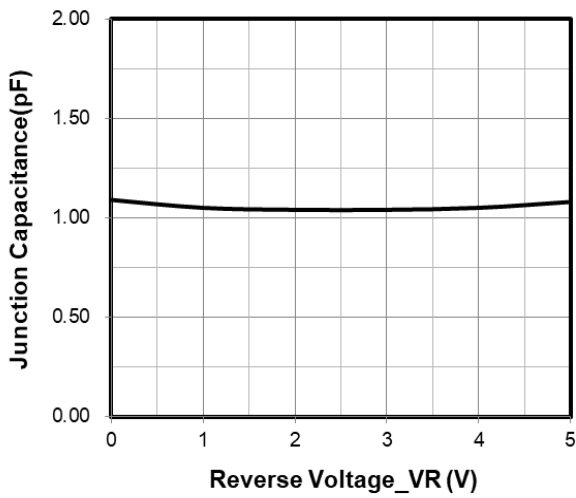

**Junction Capacitance vs. Reverse Voltage**

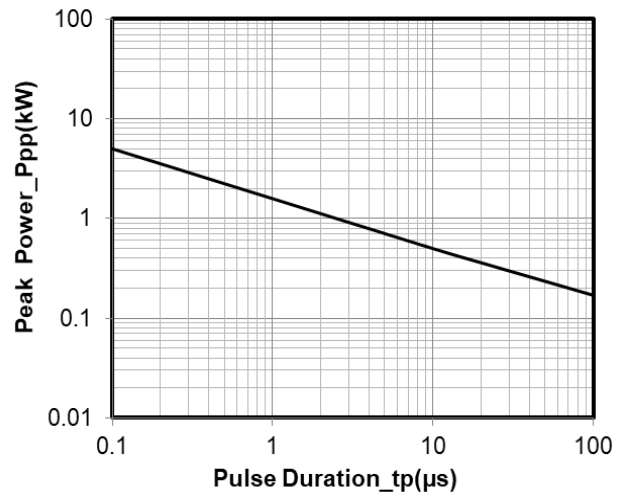

**Peak Pulse Power vs. Pulse Time**

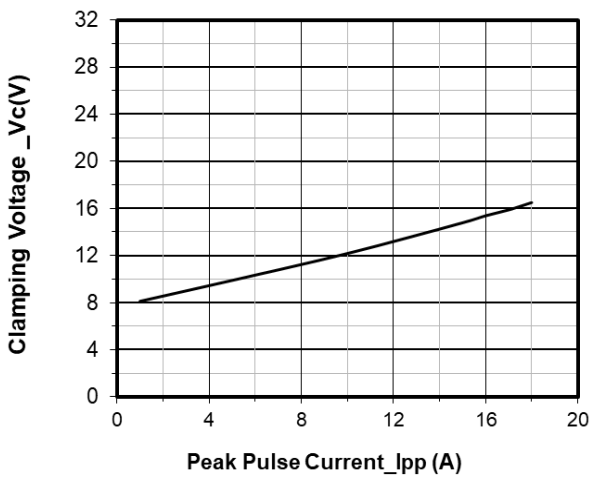

**Clamping Voltage vs. Peak Pulse Current**

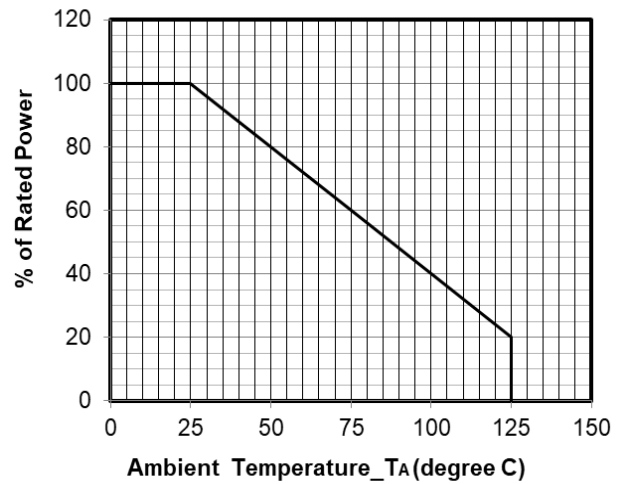

**Power Derating Curve**

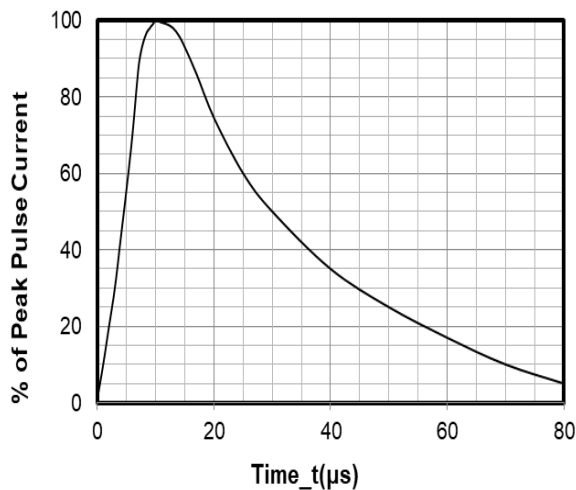

**8 X 20μs Pulse Waveform**

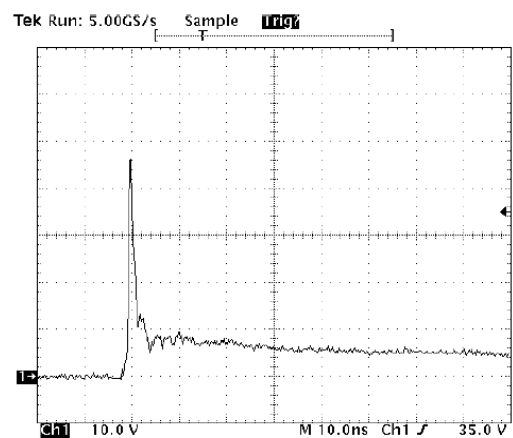

Note: Data is taken with a 10x attenuator

**ESD Clamping Voltage  
8 kV Contact per IEC61000-4-2**

### SOD-323 Package Outline Drawing

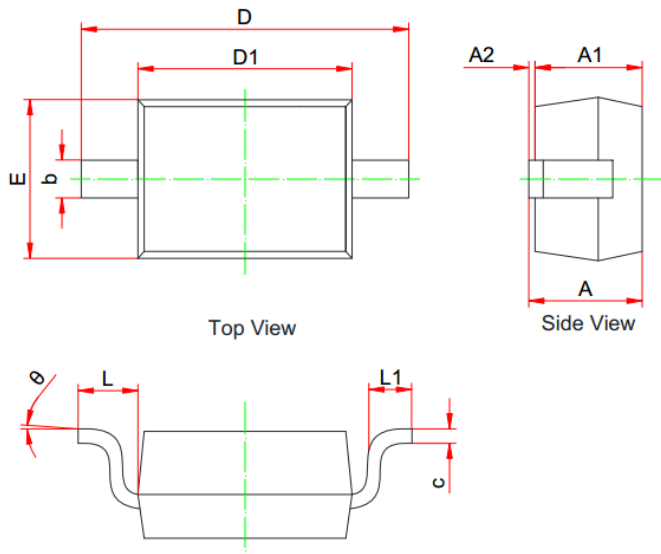

SYM	MILLIMETERS		
	MIN	NOM	MAX
A	0.800	--	1.100
A1	0.800	--	0.900
A2	0.000	--	0.100
b	0.250	--	0.400
c	0.080	--	0.177
D1	1.600	1.700	1.800
D	2.300	--	2.800
E	1.150	--	1.400
L	0.475REF		
L1	0.100	--	0.500
$\Theta$	0°	--	8°

### Suggested Land Pattern



**Unit: mm**

### Contact Information

Applied Power Microelectronics Inc.

Website: <http://www.appliedpowermicro.com>

Email: [sales@appliedpowermicro.com](mailto:sales@appliedpowermicro.com)

Phone: +86 (0519) 8399 3606