

Description

The AR0501P1A is an uni-directional TVS diode, utilizing leading monolithic silicon technology to provide fast response time and low ESD clamping voltage, making this device an ideal solution for protecting voltage sensitive high-speed data lines. The AR0501P1A has an ultra-low capacitance with a typical value at 0.5pF, and complies with the IEC 61000-4-2 (ESD) with $\pm 20\text{kV}$ air and $\pm 20\text{kV}$ contact discharge. It is assembled into an ultra-small 1.0x0.6x0.5mm lead-free DFN package. The small size, ultra-low capacitance and high ESD surge protection make AR0501P1A an ideal choice to protect cell phone, digital visual interfaces, HDMI, DVI, USB2.0, USB3.0, and other high speed ports.

Features

- Ultra low capacitance: 0.5pF typical
- Ultra low leakage: nA level
- Operating voltage: 5V
- Low clamping voltage
- 2-Pin leadless package
- Complies with following standards:
 - IEC 61000-4-2 (ESD) immunity test
 - Air discharge: $\pm 20\text{kV}$
 - Contact discharge: $\pm 20\text{kV}$
 - IEC61000-4-5 (Lightning) 4.5A (8/20 μs)
- RoHS Compliant

Mechanical Characteristics

- Package: DFN1006-2
- Case Material: “Green” Molding Compound.
- Terminal Connections: See Diagram Below
- Marking Information: See Below

Applications

- Cellular Handsets and Accessories
- Display Ports
- MDDI Ports
- USB Ports
- Digital Visual Interface (DVI)
- PCI Express and Serial SATA Ports

Marking Information



5W = Device Marking Code

Equivalent Circuit and Pin Configuration

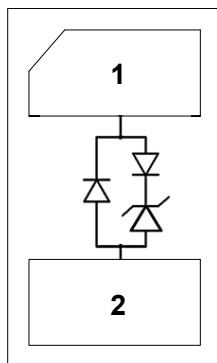

Circuit and Pin Schematic

Ordering Information

Part Number	Packaging	Reel Size
AR0501P1A	10000/Tape & Reel	7 inch

Absolute Maximum Ratings (T_A=25°C unless otherwise specified)

Parameter	Symbol	Value	Unit
Peak Pulse Power (8/20μs)	P _{pk}	67.5	W
Peak Pulse Current (8/20μs)	I _{PP}	4.5	A
ESD per IEC 61000-4-2 (Air)	V _{ESD}	±20	kV
ESD per IEC 61000-4-2 (Contact)		±20	
Operating Temperature Range	T _J	-55 to +125	°C
Storage Temperature Range	T _{stg}	-55 to +150	°C

Electrical Characteristics (T_A=25°C unless otherwise specified)

Parameter	Symbol	Min	Typ	Max	Unit	Test Condition
Reverse Working Voltage	V _{RWM}			5	V	
Breakdown Voltage	V _{BR}	6			V	I _T = 1mA
Reverse Leakage Current	I _R			0.5	μA	V _{RWM} = 5V
Clamping Voltage	V _C			10	V	I _{PP} = 1A (8 x 20μs pulse)
Clamping Voltage	V _C			15	V	I _{PP} = 4.5A (8 x 20μs pulse)
Junction Capacitance	C _J		0.5		pF	V _R = 0V, f = 1MHz

Typical Performance Characteristics (TA=25°C unless otherwise Specified)

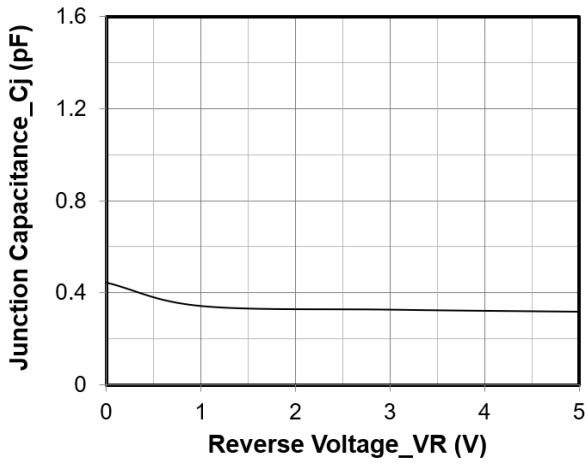

Junction Capacitance vs. Reverse Voltage

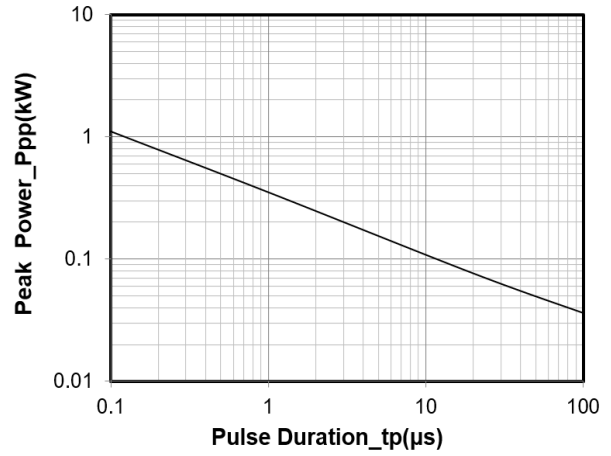

Peak Pulse Power vs. Pulse Time

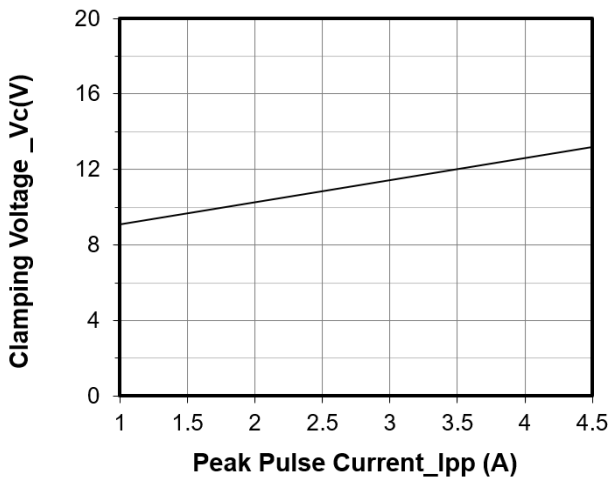

Clamping Voltage vs. Peak Pulse Current (tp = 8/20 μs)

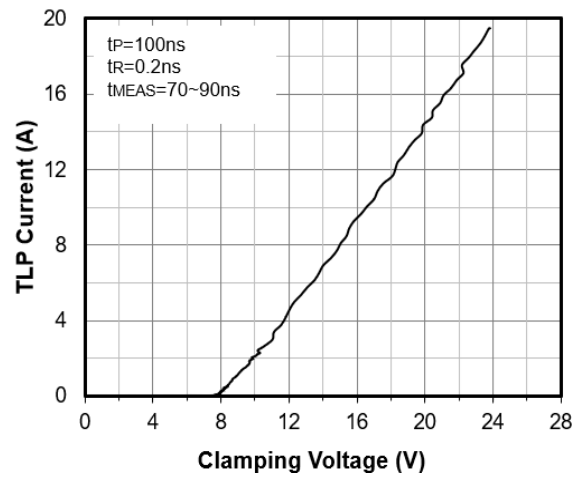

TLP Measurement

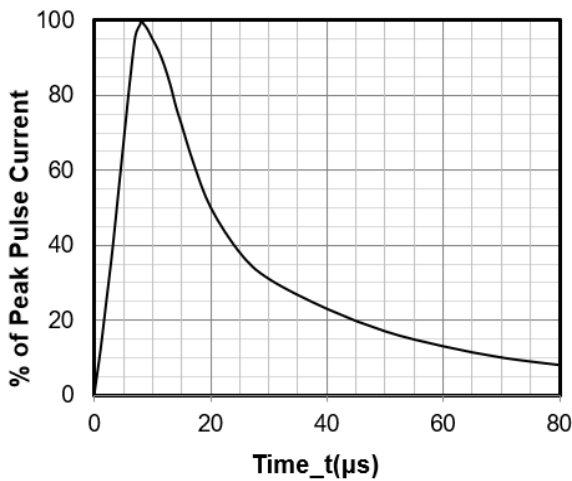

8 X 20 μs Pulse Waveform

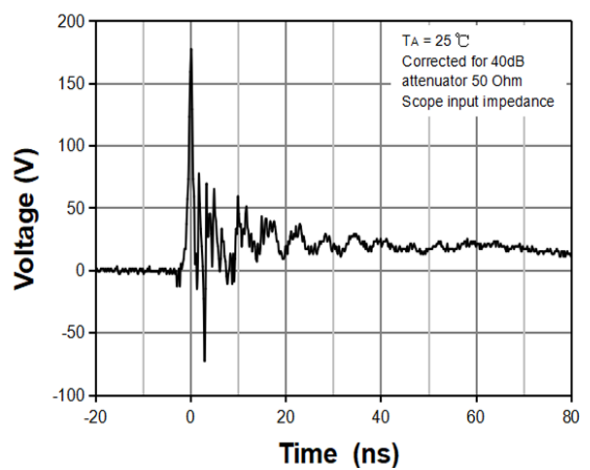

ESD Clamping Voltage
8 kV Contact per IEC61000-4-2

DFN1006-2 Package Outline Drawing

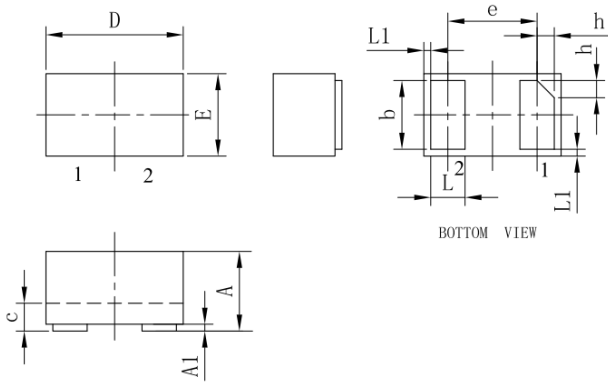

SYM	DIMENSIONS					
	MILLIMETERS			INCHES		
	MIN	NOM	MAX	MIN	NOM	MAX
A	0.45	0.50	0.55	0.018	0.020	0.022
A1	0.00	0.02	0.05	0.000	0.001	0.002
b	0.45	0.50	0.55	0.018	0.020	0.022
c	0.12	0.15	0.18	0.005	0.006	0.007
D	0.95	1.00	1.05	0.037	0.039	0.041
e	0.65 BSC			0.026 BSC		
E	0.55	0.60	0.65	0.022	0.024	0.026
L	0.20	0.25	0.30	0.008	0.010	0.012
L1	0.05REF			0.002REF		
h	0.07	0.12	0.17	0.003	0.005	0.007

Suggested Land Pattern

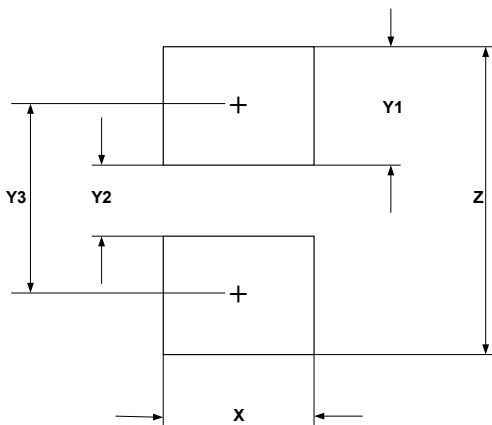

SYM	DIMENSIONS	
	MILLIMETERS	INCHES
X	0.60	0.024
Y1	0.50	0.020
Y2	0.30	0.012
Y3	0.80	0.032
Z	1.30	0.052

Contact Information

Applied Power Microelectronics Inc.
 Website: <http://www.appliedpowermicro.com>
 Email: sales@appliedpowermicro.com
 Phone: +86 (0519) 8399 3606