

WP4500T200.0

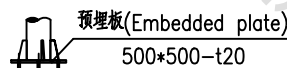

基础示意图(客户提供)
foundation(Provide by Customer)

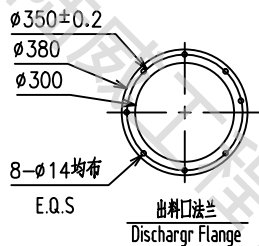
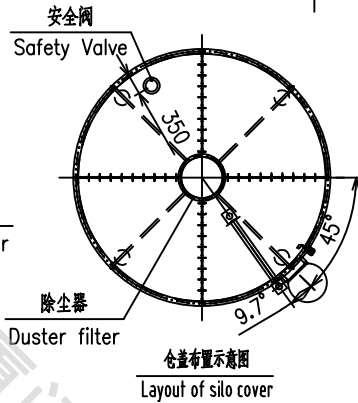
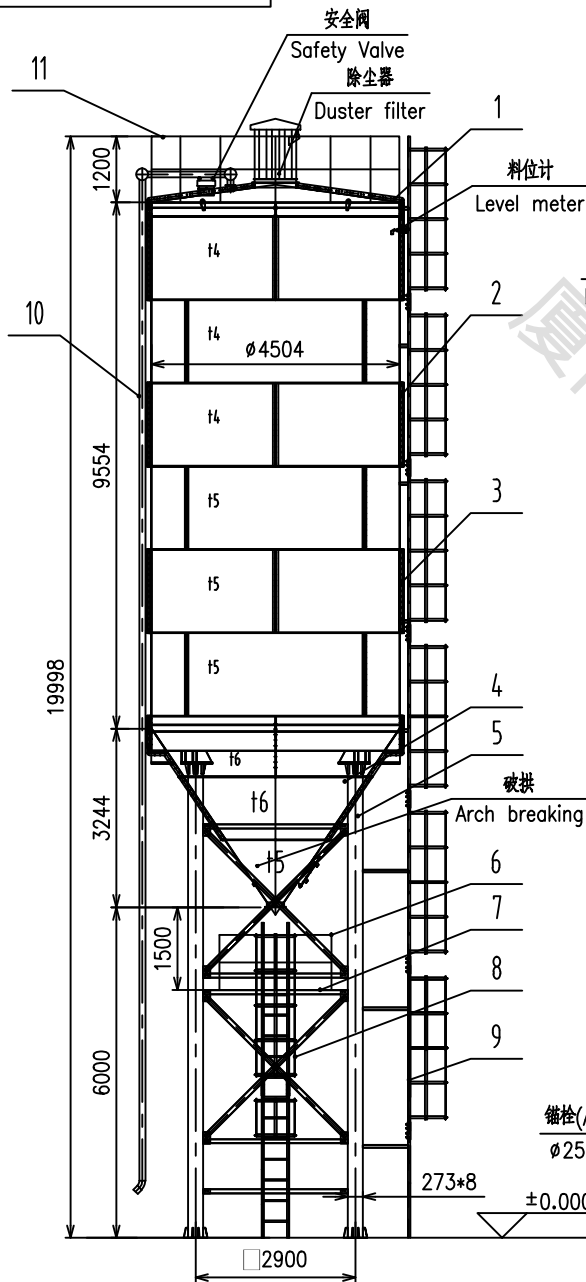
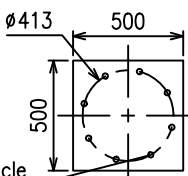

锚栓(Anchor bolt)8 article
φ25,L=600 均布(E.Q.S)

埋板示意图(客户提供)

Embedded plate sketch drawing(Provide by Customer)

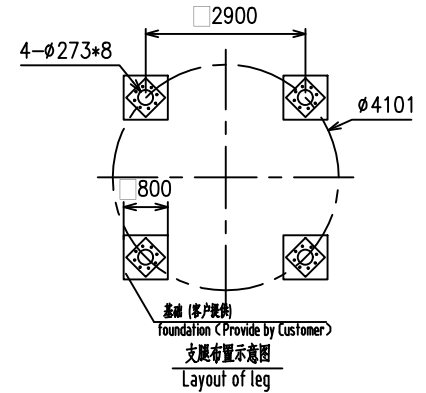
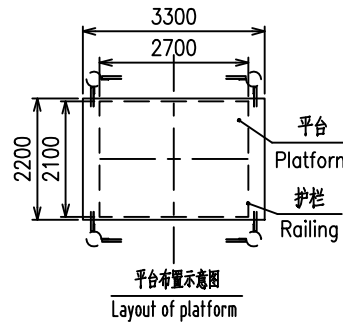

技术参数(Technical Parameter):

- 筒仓容量221T, 扣除500高料位装载210T, 装载效率95.3%, 密度按1.3t/m³计;
(Capacity 221T, Actual Capacity 210T, Volume Ratio 95.3%, Density 1.3t/m³;))
- 底漆: 铁红环氧防锈底漆, 面漆: 丙烯酸面漆, 颜色业主定;
(Primer: Iron red epoxy antirust primer, Finish paint: pioner topcoat, Customer specified color;)
- 使用条件: 压力<5KPa, 风压: 0.8KN/m².
(Use conditions: Pressure<5KPa, Wind pressure: 0.8KN/m².)

借通用件登记

描图

校描

旧底图总号

签字

日期

11	WP4500T200.11	顶护栏(Silo top railing)	1	Q235B			
10	WP4500T200.10	进灰管(Feed pipe)	1	Q235B			
9	WP4500T200.9	仓顶爬梯(Top Straight ladder)	1	Q235B			
8	WP4500T200.8	平台爬梯(Platform Straight ladder)	1	Q235B			
7	WP4500T200.7	平台(Platform)	1	Q235B			
6	WP4500T200.6	平台护栏(Platform railing)	1	Q235B			
5	WP4500T200.5	支腿架(Leg assembly drawing)	1	Q235B			
4	WP4500T200.4	锥体(Cone)	1	Q235B			
3	WP4500T200.3	仓板2(Silo body plate2)	9	Q235B			
2	WP4500T200.2	仓板1(Silo body plate1)	9	Q235B			
1	WP4500T200.1	仓盖(Silo cover)	1	Q235B			

序号 NO.	代号 CODE	名称/NAME	数量 Q.T.Y	材料 MATERIAL	单重 S-WEIGHT	总重 T-WEIGHT	备注 MARK
					重量 WEIGHT	重量 WEIGHT	

方案图(Plan Drawing)

厦门陆威工程机械有限公司
Xiamen Luwei Construction Equipment Co., Ltd.

WPφ4500-200T-H6000

WP4500T200.0

标记	数量	更改文件号	签字	日期
设计 Designer	标准化 Standardization			
标准化 Standardization				
标准化 Standardization				
标准化 Standardization				
日期/Date				

图样标记	版本	重量/Weight	比例/Scale
			1:90
Total Pages共		页	Pages第
		页	页