



GACIA



N8 Product Information

GACIA

GACIA ELECTRICAL APPLIANCE CO., LTD.

Add: 545#Dongdajie, Beibaixiang, Baitawang Industrial Zone, Wenzhou Zhejiang, China

Tel: 86-577-62982555 Fax: 86-577-62983555

E-mail: gacia@gacia.com.cn [Http://www.gacia.com.cn](http://www.gacia.com.cn)





Gacia Electrical Appliance Co., Ltd

is an export-oriented company, focus on R&D, manufacturing, and sales of circuit breakers. Through 16 years of rapid growth, Gacia has 1700 employees, including 100 technical talents, and 3 manufacturing bases around China. Gacia's headquarter located in Wenzhou, the Shanghai campus focus on R&D and high-end manufacturing, and the Jiang xi campus provide OEM manufacturing services for customers all over the world. Meanwhile, Gacia's products export to over 100 countries and regions, and 80% of them are independent developed by Gacia. A majority of Gacia's products authenticated by many international professional certifications including German TUV, VDE certifications, Dutch KEMA certification and ISO 9001 international quality system.

After more than a decade of development, Gacia adhere to business principle referring to "customer-centric, Altruism and Win-win". Besides, Gacia devoted to utilize innovation to drive production improvement, take advantage of lean production to upgrade products quality and committed to become the pacemaker of the global circuit breaker industrial.

CONTENTS

MCB

Description	1-3
Main Technical Paramters	4-6
Dimensions	6-7

RCBO

N8GNLE / N8GLE Description	8
Main Technical Paramters	9-10
Dimensions	11
N8LBE Description	12
Main Technical Paramters	13
N8BNLE / N8BLE Description	14
Main Technical Paramters	15-16
Dimensions	17

RCCB

N8GNLE / N8GLE Description	18
Main Technical Paramters	19
Dimensions	20



Core Manufacturing Advantages

- 01 Independent Research and develop hot runner mold which can drop 8 pcs shells one time.
- 02 Injection closing unit device with automatic clamping and shaping process instead of traditional labour.
- 03 High-speed Punch Press Machine & Auto Welding Machine. The integration of stamping and welding process could reduce components damage and increase the qualification rate significantly for the metal parts.

- 04 Intelligent Manufacturing with quality auto monitoring pack and data interconnection pack could avoid artificial errors and improve product reliability.
- 05 Operating Mechanism plant and Tripper plant. The most important parts of RCD are produced by GACIA to insure quality warranty.

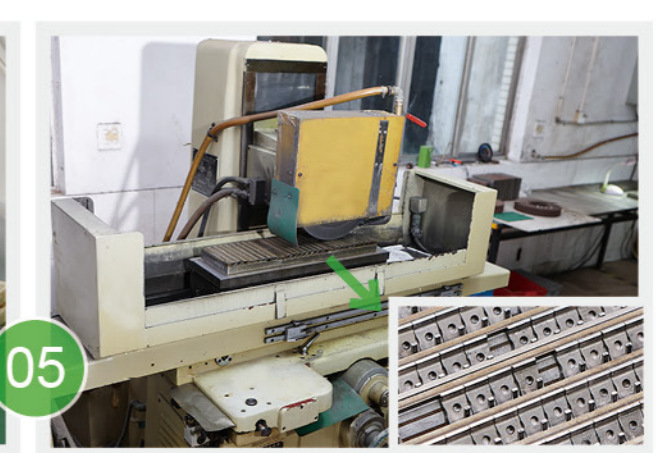
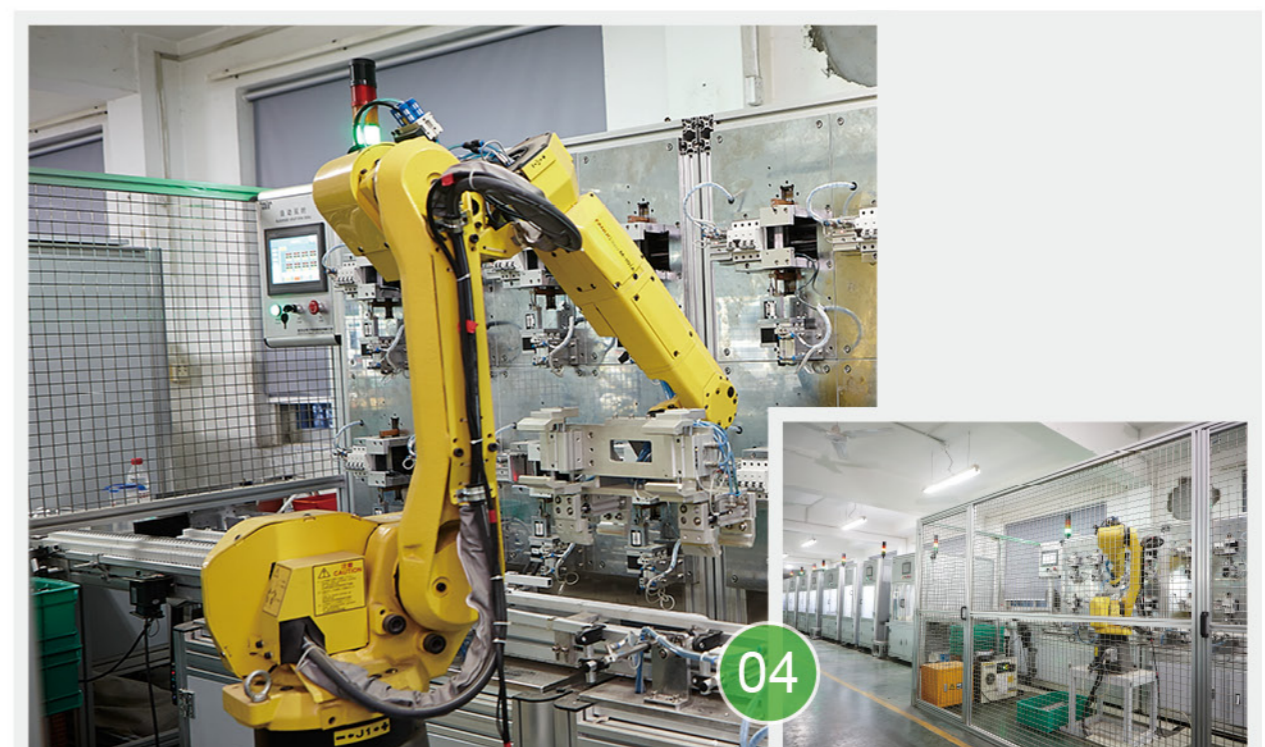
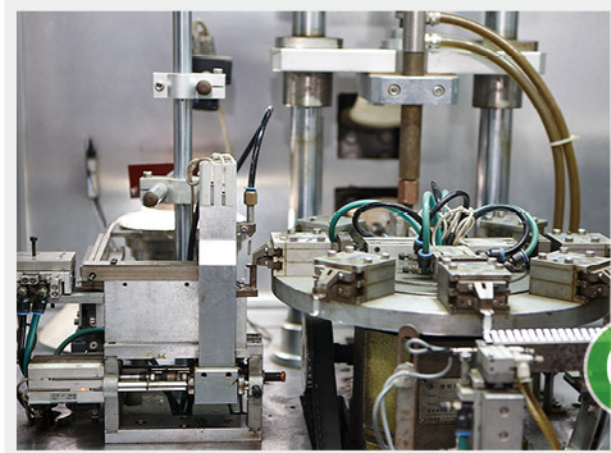
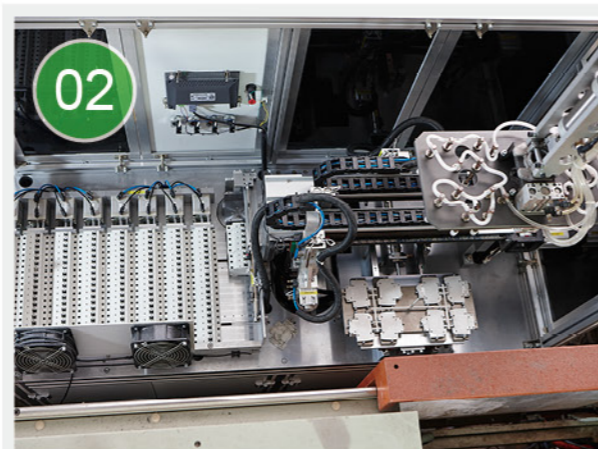
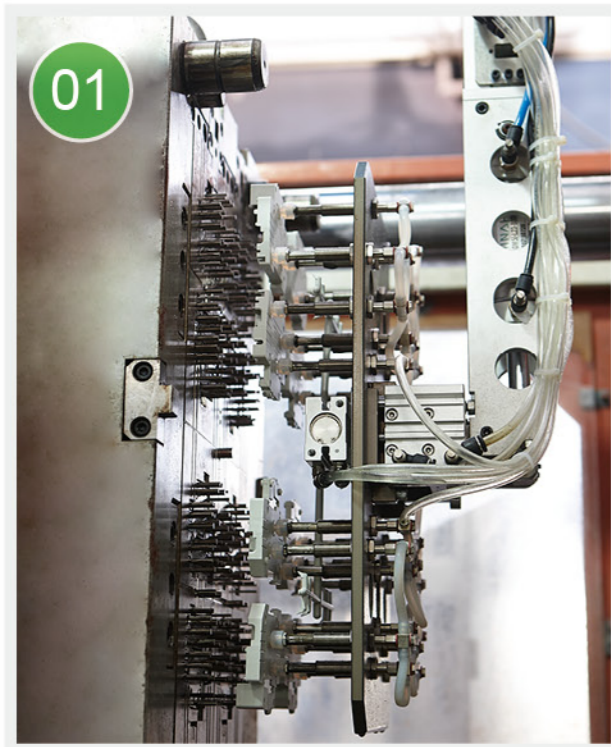

Pacemaker
of circuit breakers

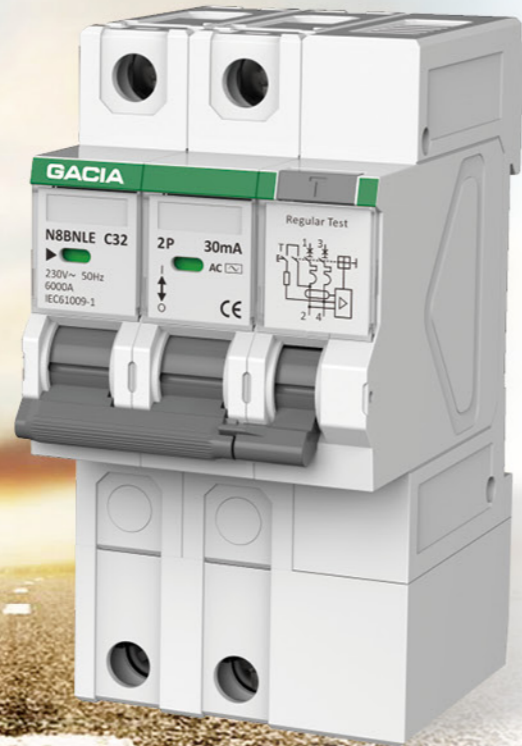
Quality Warranty:

Complete Manufacturing System for Components&Parts

Precise Manufacturing Process

Selecting High-class Raw Material

Strict Detecting System

Using Occasions:

Residential, Commercial, Industrial, Tender, Projects Uses | ★★★★★

Your Contact Sales Here at GACIA



Devin Ying

Marketing Director
Mobile: +86-13968793666
E-mail: devin@gacia.com.cn



A long

Head of Order Processing
Mobile: +86-1875772155
E-mail: huangfeilong@gacia.com.cn



Tina

South American Market Manager
Mobile: +86-1875772168
E-mail: tina@gacia.com.cn



Jody

European Market Manager
Mobile: +86-1875772199
E-mail: jody@gacia.com.cn



Simon

South of Asia Market Manager
Mobile: +86-1875772055
E-mail: bairuibo@gacia.com.cn



Lee

Middle East Market Manager
Mobile: +86-1875772099
E-mail: lee@gacia.com.cn



Ivy

Middle Asian Market Manager
Mobile: +86-1875772123
E-mail: ivy@gacia.com.cn



Lulu

ASEAN Market
Mobile: +86-13968779753
E-mail: zhaolulu@gacia.com.cn





A/F Hotline

+86-577-62988823
E-mail: services@gacia.com.cn

Tech Support Hotline

+86-577-62988822
E-mail: tech@gacia.com.cn

Model	UB7N	N8DN	N8DH
IEC/EN 60898-1 IEC/EN 60947-2			
Poles	1P, 2P, 3P, 4P	1P+N	1P+N
Certification			
Electrical Specification			
Rated current(A)	In	1-63	6-40
Rated frequency(Hz)		50/60	50/60
Rated working voltage(V)	Ue	1P:230/400~,2/3/4P:400~	230~
Rated insulated voltage(V)	Ui	500	400
Impulse withstand voltage(kV)	Uimp	4	4
Rated short-circuit breaking capacity(KA)	Icn	6	10
Instantaneous tripping type		B,C,D	B,C,D
Maximum working voltage	Umax	1P:240,2/3/4P:440	240
Dielectric test voltage(kV)		2	2
Service life	Mechanical	10000	10000
(O-C)	Electrical	6000	6000
Control And Indication			
Shunt release(SHT)		<input type="checkbox"/>	
Undervoltage release(UVT)		<input type="checkbox"/>	
Auxiliary contact(AUX)		<input type="checkbox"/>	
Alarm contact(ALT)		<input type="checkbox"/>	
Contact position indicator		<input type="checkbox"/>	
Fault indication		<input type="checkbox"/>	
Connection And Installation			
Ambient temperature(with daily average≤35℃)		-5℃ ~+40℃	
Protection degree	ALL Sides	IP40	
	Connection Terminal	IP20	
Wire(mm ²)	1-16	1-10	1-10
busbar(mm ²)	16	-	-
Mounting	On DIN rail	On DIN rail	On DIN rail
Pollution degree			2
Reference temperature for setting of thermal element(℃)			30
Storage temperature(℃)			-25℃ ~+70℃
Tightening torque	3.0	2	2
Connection			Top and Bottom
Dimensions(mm) (WxHxL)	a(1P/2P/3P/4P)	18/36/54/72	18
	b(1P/2P/3P/4P)	87/87/87/87	87
	c(1P/2P/3P/4P)	78/78/78/78	77
Weight(kg)	1P	0.13	0.19
	2P	0.26	0.38
	3P	0.39	0.57
	4P	0.52	0.76

■ Default □ Optional - None

N8BN	N8BH	N8G
		
1P, 2P, 3P, 4P	1P, 2P, 3P, 4P	1P, 2P, 3P, 4P
Electrical Specification		
1-63A	1-63A	63-125
50/60	50/60	50/60
1P:230/400~,2/3/4P:400~	1P:230/400~,2/3/4P:400~	1P:230/400~,2/3/4P:400~
500	500	500
4	4	4
6	10	10
B,C,D	B,C,D	C,D
1P:240,2/3/4P:440	1P:240,2/3/4P:440	1P:240,2/3/4P:440
2	2	2
10000	10000	10000
6000	6000	2000
Control And Indication		
	<input type="checkbox"/>	
	<input type="checkbox"/>	
	<input type="checkbox"/>	
	<input type="checkbox"/>	
	<input type="checkbox"/>	
	<input type="checkbox"/>	
Connection And Installation		
	-5℃ ~+40℃	
	IP40	
	IP20	
1-16	1-16	25-50
16	16	-
On DIN rail	On DIN rail	On DIN rail
	2	
	30	
	-25℃ ~+70℃	
3.0	3.0	3.5
	Top and Bottom	
18/36/54/72		27/54/81/108
87/87/87/87		87/87/87/87
78/78/78/78		78/78/78/78
0.13		0.18
0.26		0.36
0.39		0.54
0.52		0.72

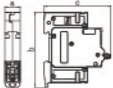
Model		N8SG	
IEC/EN 60947-3			
Poles		1P, 2P, 3P, 4P	
Certification		CE	
Electrical Specification			
Rated current(A)	In	16-125	
Rated frequency(Hz)		50/60	
Rated working voltage(V)	Ue	1P:230/400~,2/3/4P:400~	
Rated insulated voltage(V)	Ui	500	
Impulse withstand voltage(kV)	Uimp	4	
Rated short-time withstand current(KA)	Icw	1.5	
Instantaneous tripping type		-	
Maximum working voltage	Umax	1P:240,2/3/4P:440	
Dielectric test voltage(kV)		2.5	
Service life (O-C)	Mechanical	Standard value	8500
	Electrical	Standard value	1500
Control And Indication			
Shunt release(SHT)		-	
Undervoltage release(UVT)		-	
Auxiliary contact(AUX)		-	
Alarm contact(ALT)		-	
Contact position indicator		-	
Fault indication		-	
Connection And Installation			
Ambient temperature(with daily average≤35℃)		-5℃ ~+40℃	
Protection degree	ALL Sides	IP40	
	Connection Terminal	IP20	
Wire(mm ²)		1-50	
busbar(mm ²)		-	
Mounting		On DIN rail	
Pollution degree		3	
Reference temperature for setting of thermal element(℃)		30	
Storage temperature(℃)		-25℃ ~+70℃	
Tightening torque		3.5	
Connection		Top and Bottom	
Dimensions(mm) (WxHxL)	 a(1P/2P/3P/4P)	18/36/54/72	
	b(1P/2P/3P/4P)	87/87/87/87	
	c(1P/2P/3P/4P)	78/78/78/78	
Weight(kg)	1P	0.08	
	2P	0.16	
	3P	0.24	
	4P	0.32	

■ Default □ Optional - None

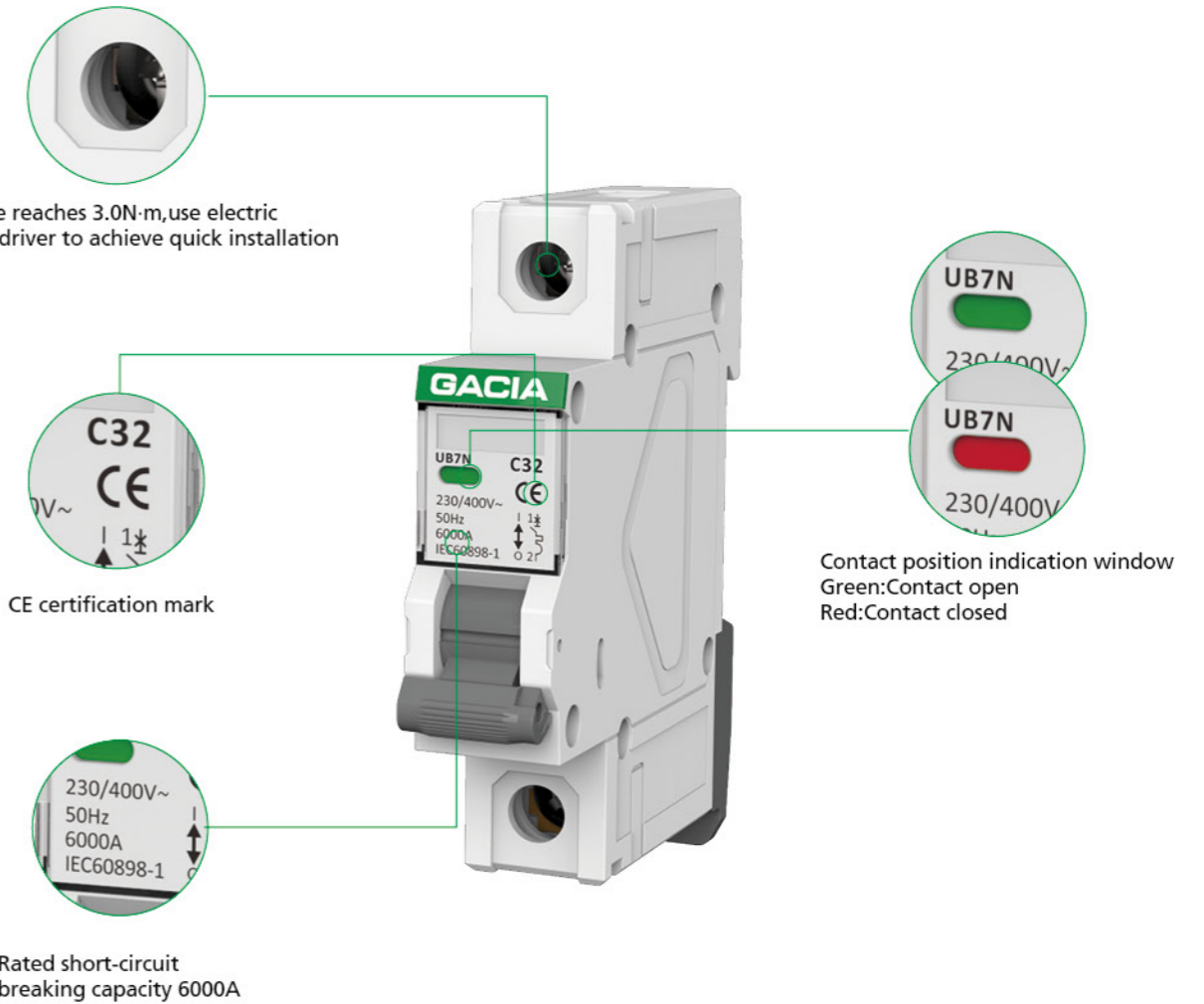

Normal Working Conditions and Installation Conditions:

- ◆ Ambient Temperature: -5℃ ~+40℃ , it's average over a period of 24 hours does not exceed +35℃ .
- ◆ Height above Sea Level: ≤ 2000m.
- ◆ Atmospheric Condition:
 - When the maximum temperature is +40℃ , the relative humidity of the air is not exceed 50%, and it has higher humidity at lower temperature. The maximum monthly relative humidity is 90%, and the lowest temperature is +20℃ . Additionally, a frost might be present, with the temperature change.
 - Pollution Degree: UB7N,N8DN/H,N8BN/H,N8G:2;N8SG:3.
- ◆ Installation Conditions:
 - Installation Category and Type: Installation category is II or III, and the installation type adopts standard steel guide rail installation (TH35-7.5).
 - The circuit breaker shall be installed vertically, and the upward position of the handle shall be connected to the power.
 - The installation should be free from obvious impact and vibration, corrosive and explosive gases.

Characteristics Curve

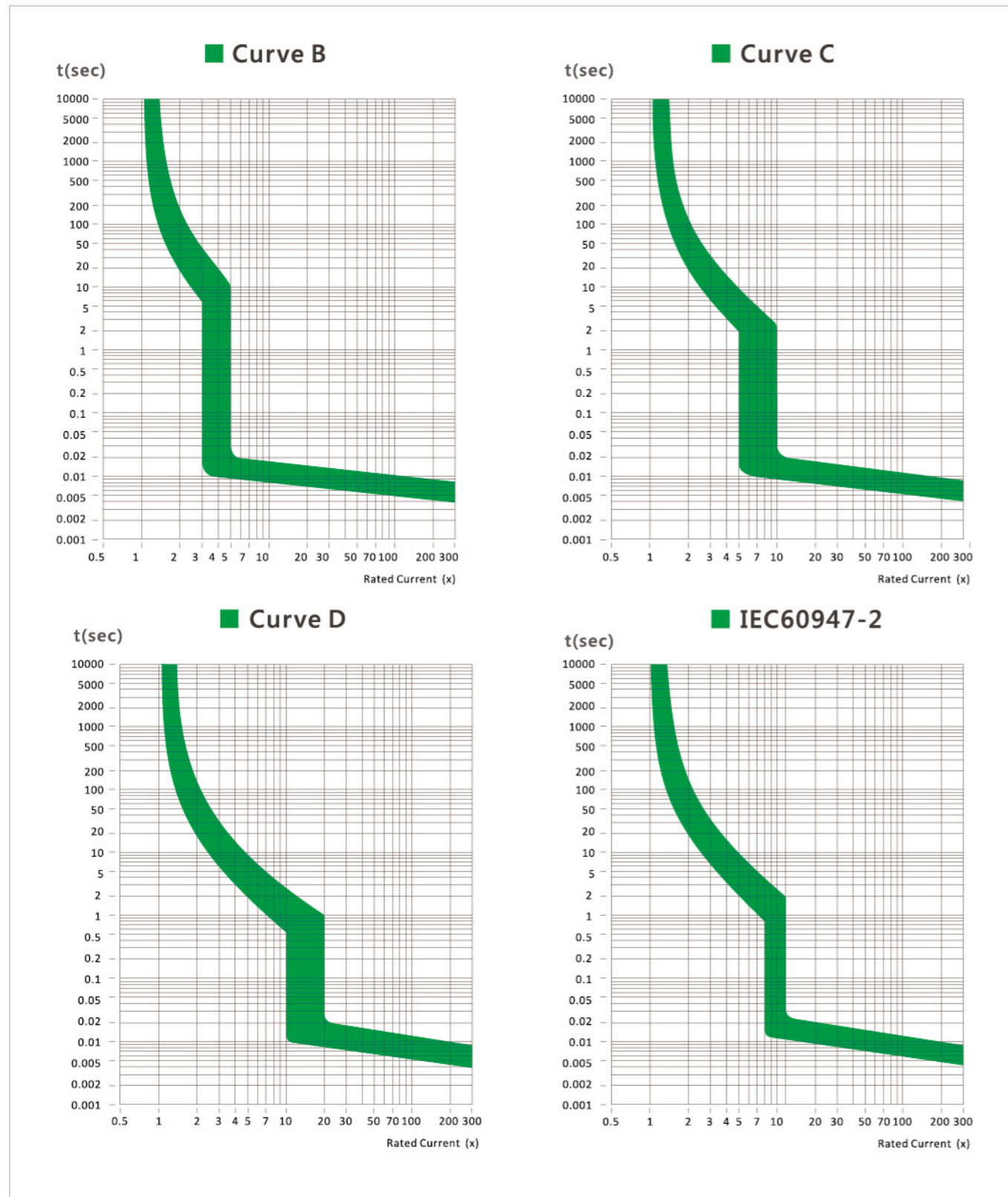

Time-current operating characteristics

Test	Type	Test current	Initial condition	Limits of tripping or non-tripping time	Result to be obtained	Remarks
a	B, C, D	1.13I _n	Cold ^a	t ≤ 1h (for I _n ≤ 63A) t ≤ 2h (for I _n > 63A)	No tripping	
b	B, C, D	1.45I _n	Immediately following test	t < 1h (for I _n ≤ 63A) t < 2h (for I _n > 63A)	Tripping	Current steadily increased within 5s
c	B, C, D	2.55I _n	Cold ^a	1s < t < 60s (for I _n ≤ 32A) 1s < t < 120s (for I _n > 32A)	Tripping	
d	B C D	3I _n 5I _n 10I _n	Cold ^a	t ≤ 0.1s	Tripping	Current established by closing an auxiliary switch
e	B C D	5I _n 10I _n 20I _n ^b	Cold ^a	t < 0.1s	Tripping	Current established by closing an auxiliary switch

NOTE An additional test, intermediate between c and d, is under consideration for circuit-breakers of type D.

^a The term "cold" means without previous loading, at the reference calibration temperature.

^b 50 / n for special cases.

Dimensions

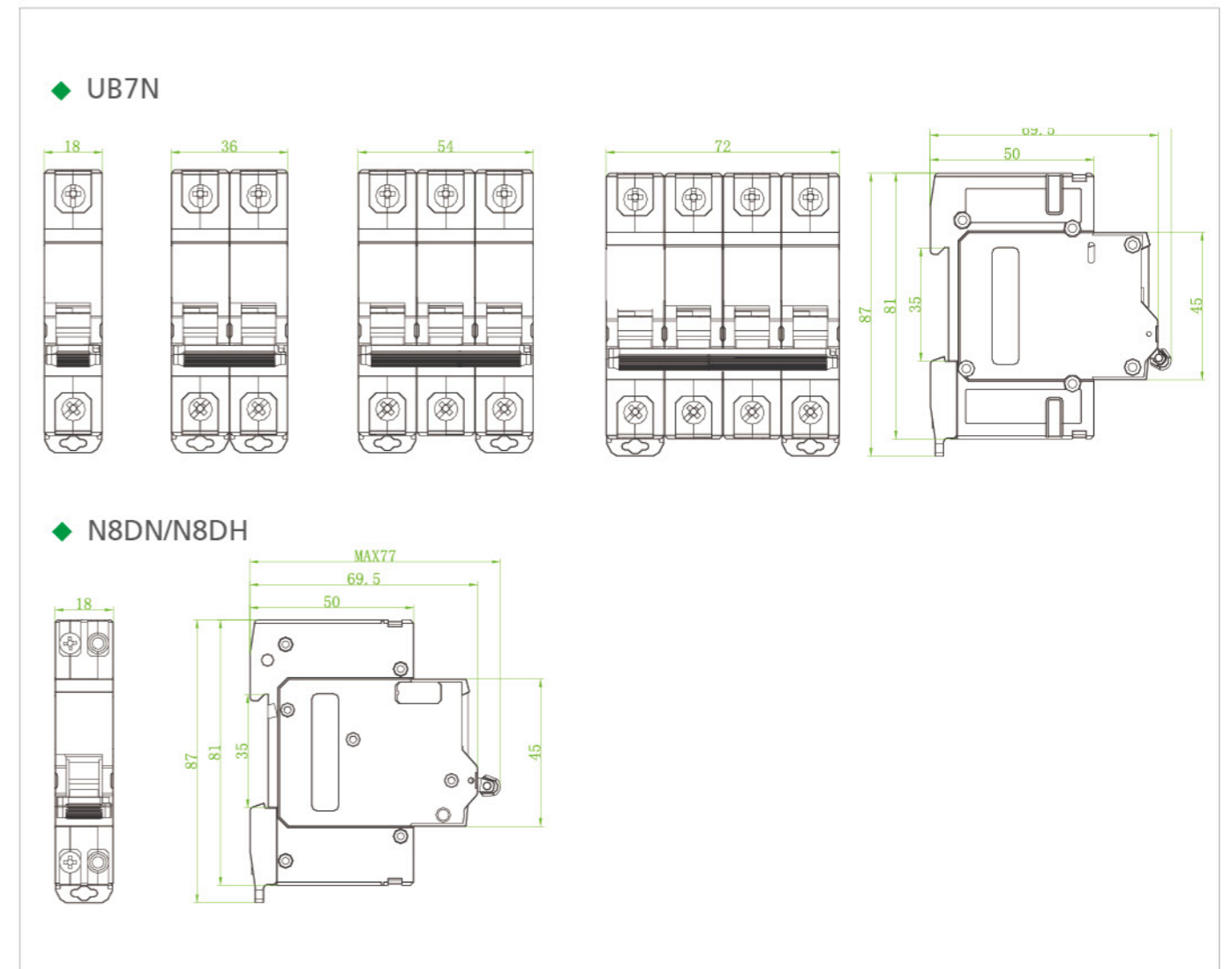

◆ N8BN/N8BH

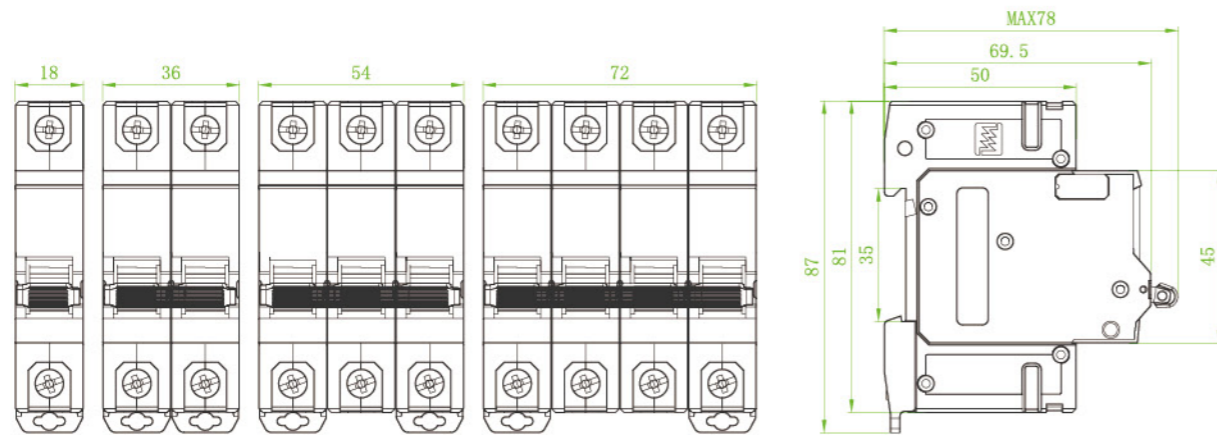

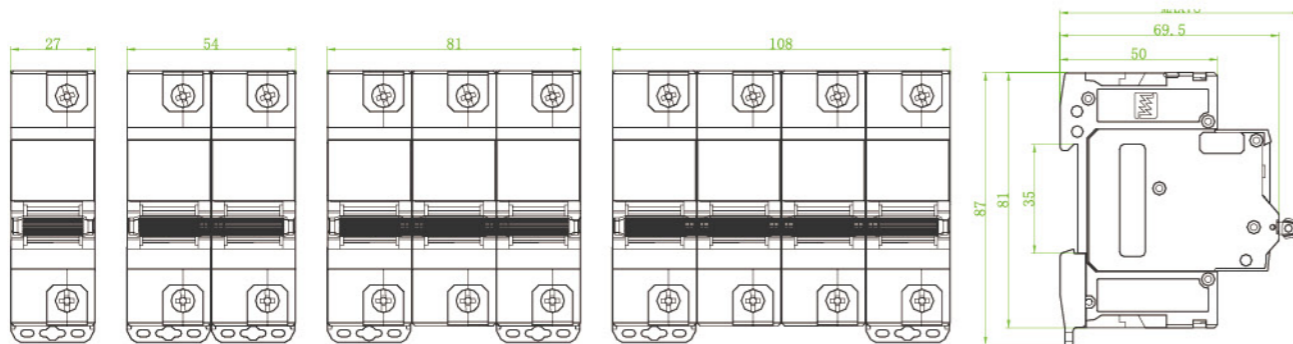

◆ N8G

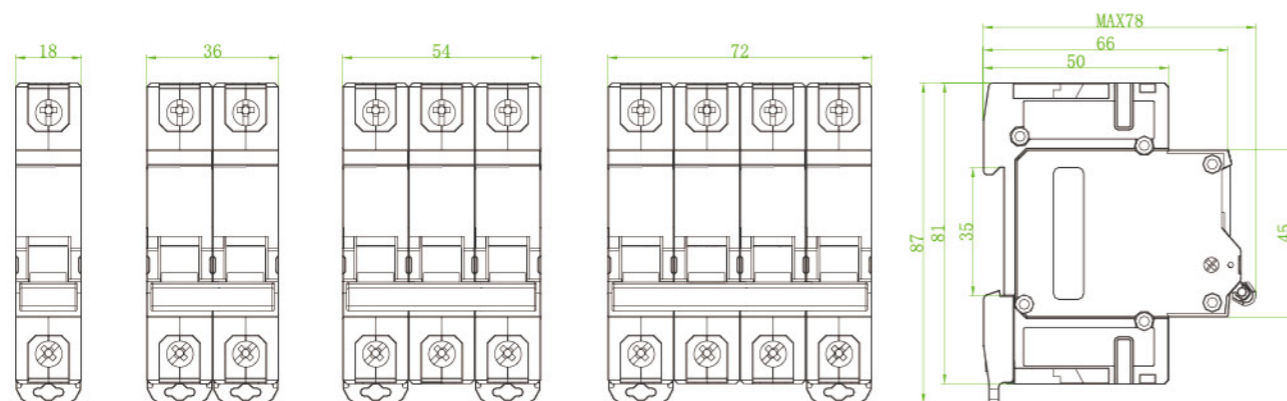

◆ N8SG



Model	N8GNLE	N8GLE
IEC/EN60947-2 GB/T 14048.2		
Poles	1P+N, 2P, 3P, 3P+N, 4P	1P+N, 2P, 3P, 3P+N, 4P
Certification	CE	
Electrical Specification		
Rated current(A)	I_n	1P+N/2P:63-125A,3P/3P+N/4P:63-100A
Rated frequency(Hz)		50/60
Rated working voltage(V)	U_e	1P+N/2P:230~,3P/3P+N/4P:400~
Rated insulated voltage(V)	U_i	500
Impulse withstand voltage(kV)	U_{imp}	6
Rated conditional short-circuit current	I_{cs}	6
Rated Residual current(mA)	$I_{\Delta n}$	30,100,300
Thermo-magnetic release characteristic		C,D
Residual current protection type		Electronic
Residual current working type		AC/A
Rated residual making and breaking capacity	$I_m / \Delta m$	10I _n
Dielectric test voltage(kV)		2.5
Service life	Mechanical Standard value	10000
(O-C)	Electrical Standard value	5000
Control And Indication		
Shunt release(SHT)		-
Undervoltage release(UVT)		-
Auxiliary contact(AUX)		-
Alarm contact(ALT)		-
Contact position indicator		■
Fault indication		■
Connection And Installation		
Ambient temperature(with daily average $\leq 35^\circ\text{C}$)		$-5^\circ\text{C} \sim +40^\circ\text{C}$
Protection degree	ALL Sides	IP40
	Connection Terminal	IP20
Wire(mm ²)		50
busbar(mm ²)		50
Mounting		Cable/Busbar
Pollution degree		3
Reference temperature for setting of thermal element(°C)		30
Storage temperature(°C)		$-25^\circ\text{C} \sim +70^\circ\text{C}$
Tightening torque		3.5
Connection		Top
Dimensions(mm)		
(WxHxL)		a(1P+N) 72 b(1P+N) 116 c(1P+N) 77
Weight(kg)	1P+N	/

■ Default □ Optional - None

Characteristics Curve

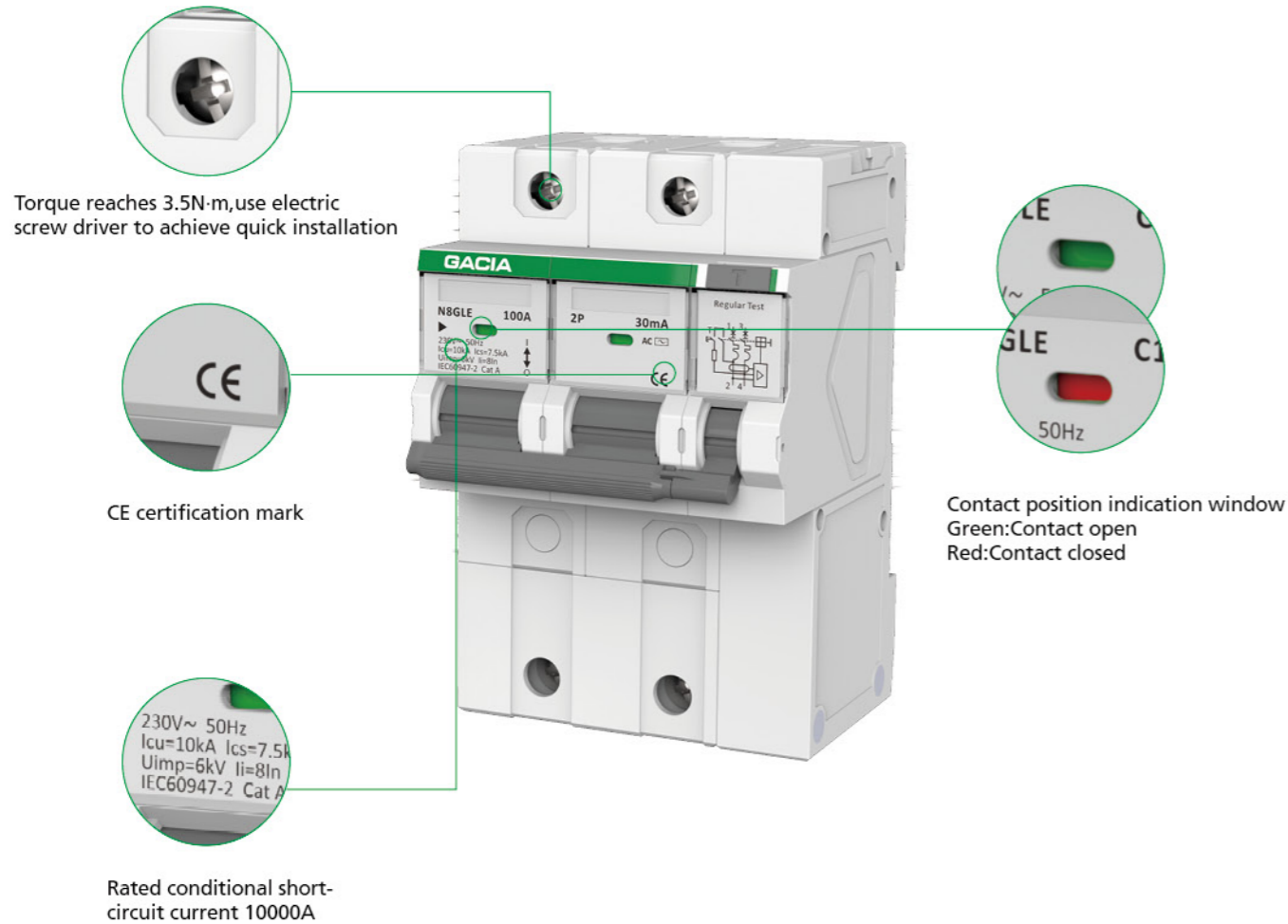

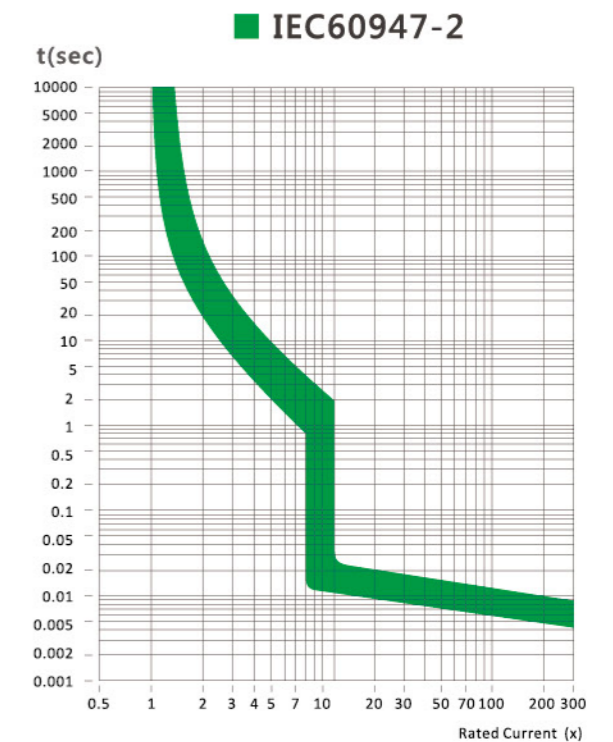
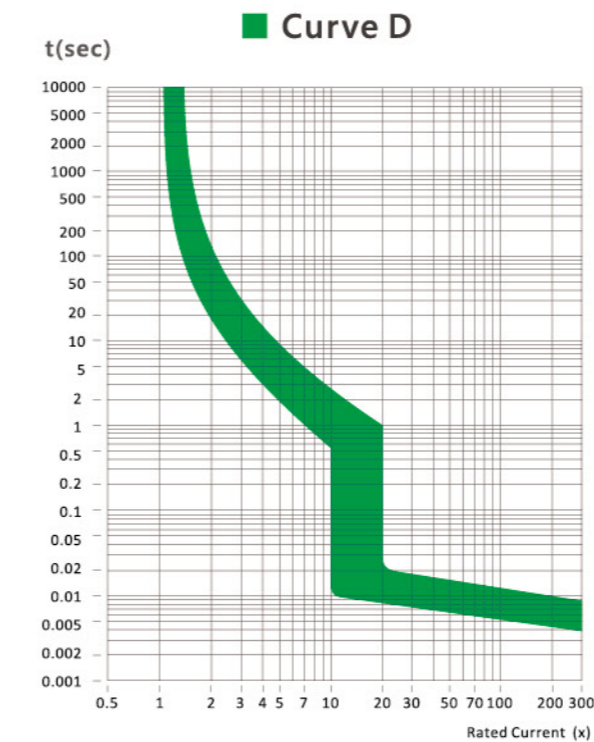
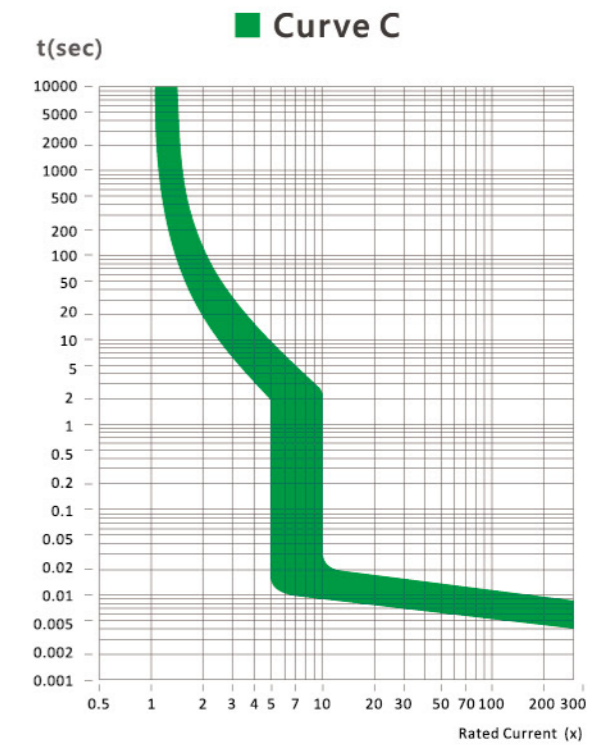
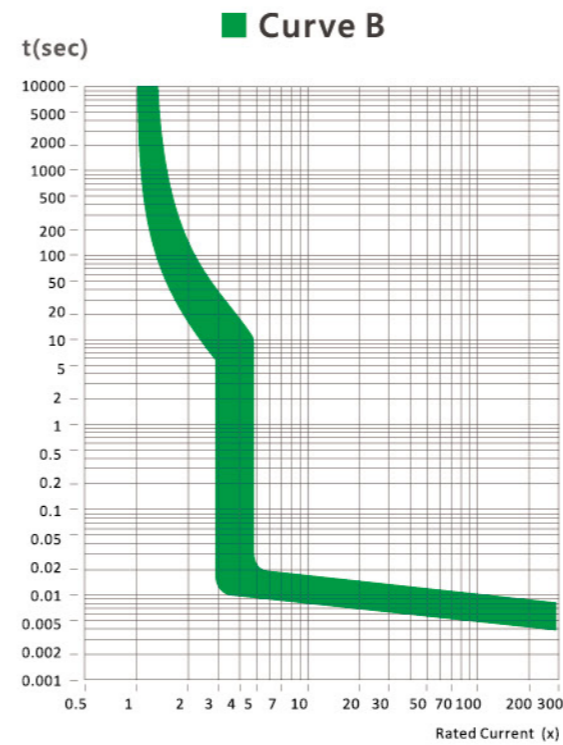

Normal Working Conditions and Installation Conditions:

- ◆ Ambient Temperature: -5°C ~+40°C
- ◆ Height above Sea Level: ≤ 2000m.
- ◆ Installation Category: III
- ◆ Pollution Degree: 3
- ◆ The installation type adopts standard steel guide rail installation (TH35-7.5).
- ◆ Installation Conditions: The external magnetic field of the installation site shall not exceed 5 -times of the earth's magnetic field in any direction. When over voltage residual current moves, the circuit breaker shall be installed vertically, and the upward position of the handle shall be connected to the power. The installation should be free from obvious impact and vibration.
- ◆ Mode of Connection: Use screws to press the wiring.

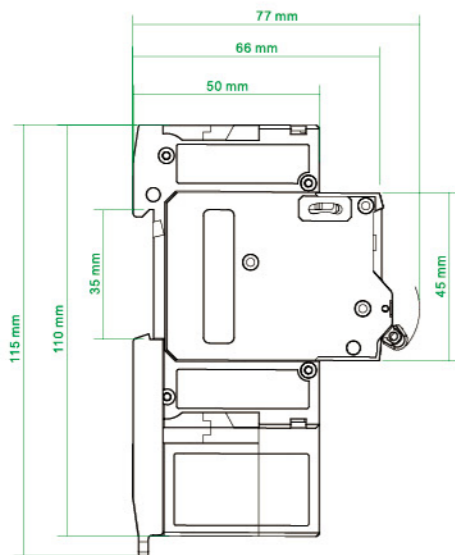
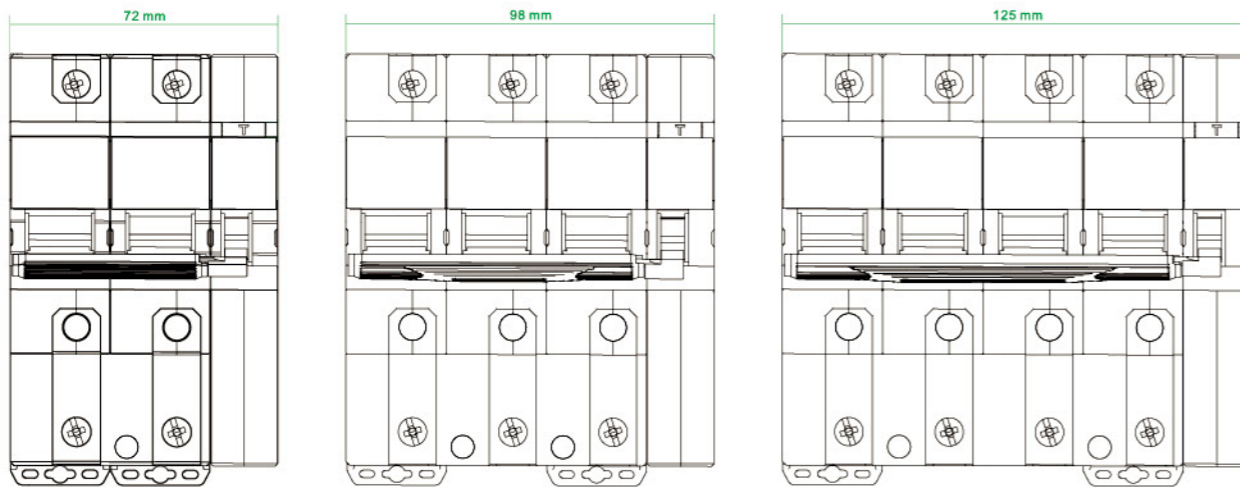

◆ N8GNLE/N8GLE 63-125A



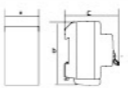

Model		N8LBE
IEC/EN 61009-1		
Poles		1P+N
Certification		
Electrical Specification		
Rated current(A)	In	6-63A
Rated frequency(Hz)		50/60
Rated working voltage(V)	Ue	230~
Rated insulated voltage(V)	Ui	400
Rated impulse withstand voltage(kV)	Uimp	4
Rated conditional short-circuit current	Ics	6(50, 63=4.5)
Rated Residual current(mA)	I Δ n	30,100,300
Thermo-magnetic release characteristic		B,C,D
Residual current protection type		Electronic
Residual current working type		AC, A
Rated residual making and breaking capacity	Im/ Δ m	500A
Dielectric test voltage(kV)		2.5
Service life	Mechanical Standard value	10000
(O-C)	Electrical Standard value	4000
Control And Indication		
Shunt release(SHT)		-
Undervoltage release(UVT)		-
Auxiliary contact(AUX)		-
Alarm contact(ALT)		-
Contact position indicator		-
Fault indication		-
Connection And Installation		
Ambient temperature(with daily average \leq 35 $^{\circ}$ C)		-5 $^{\circ}$ C ~+40 $^{\circ}$ C
Protection degree	ALL Sides	IP40
	Connection Terminal	IP20
Wire(mm 2)		6
busbar(mm 2)		16
Mounting		Cable/Busbar
Pollution degree		2
Reference temperature for setting of thermal element($^{\circ}$ C)		30
Storage temperature($^{\circ}$ C)		-25 $^{\circ}$ C ~+70 $^{\circ}$ C
Tightening torque		3.0
Connection		Top
Dimensions(mm)		a(1P+N)
(WxHxL)		b(1P+N)
		c(1P+N)
Weight(kg)	1P+N	0.20

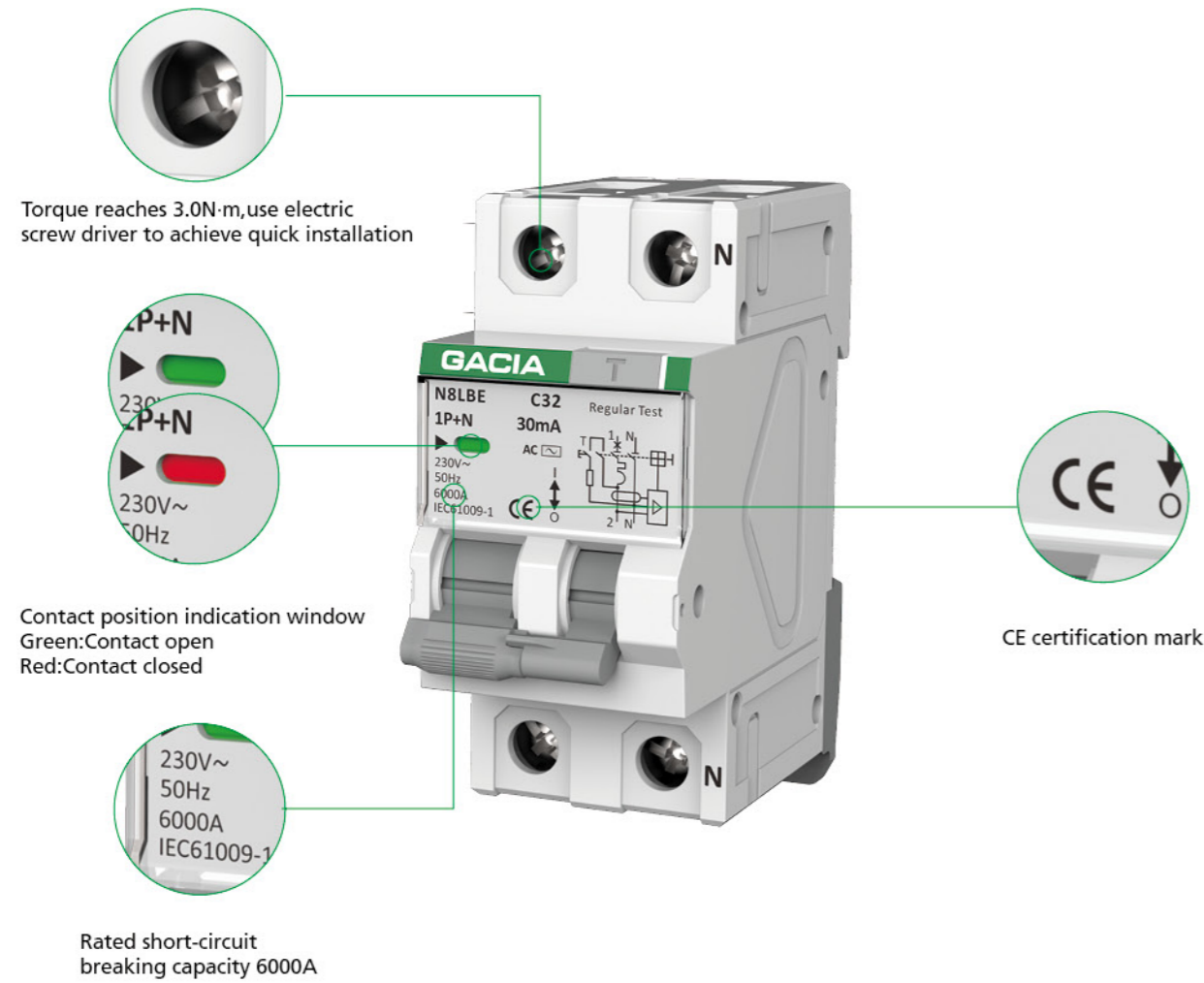
■ Default □ Optional - None



Normal Working Conditions and Installation Conditions:

- ◆ Ambient Temperature: -5℃ ~+40℃
- ◆ Height above Sea Level: ≤ 2000m.
- ◆ Installation Category: II, III
- ◆ Pollution Degree: 2
- ◆ The installation type adopts standard steel guide rail installation (TH35-7.5).
- ◆ Installation Conditions: The external magnetic field of the installation site shall not exceed 5 -times of the earth's magnetic field in any direction. When over voltage residual current moves, the circuit breaker shall be installed vertically, and the upward position of the handle shall be connected to the power. The installation should be free from obvious impact and vibration.
- ◆ Mode of Connection: Use screws to press the wiring.

Model	N8BNLE	N8BLE
GB/T 16917.1 IEC/EN 61009-1		
Poles	1P+N, 2P, 3P, 3P+N, 4P	1P+N, 2P, 3P, 3P+N, 4P
Certification	CE	CE
Electrical Specification		
Rated current(A)	In	6-63A
Rated frequency(Hz)		50/60
Rated working voltage(V)	Ue	1P+N/2P:230~,3/3P+N/4P:400~
Rated insulated voltage(V)	Ui	400
Rated impulse withstand voltage(kV)	Uimp	4
Rated conditional short-circuit current	Ics	6
Rated Residual current(mA)	I Δ n	30,50,100,300,500
Thermo-magnetic release characteristic		B,C,D
Residual current protection type		Electronic
Residual current working type		AC
Rated residual making and breaking capacity	Im/ Δ m	2000A
Dielectric test voltage(kV)		2.5
Service life	Mechanical Standard value	10000
(O-C)	Electrical Standard value	4000
Control And Indication		
Shunt release(SHT)		-
Undervoltage release(UVT)		-
Auxiliary contact(AUX)		-
Alarm contact(ALT)		-
Contact position indicator		■
Fault indication		■
Connection And Installation		
Ambient temperature(with daily average≤35℃)		-5℃ ~+40℃
Protection degree	ALL Sides	IP40
	Connection Terminal	IP20
Wire(mm ²)		16
busbar(mm ²)		16
Mounting		Cable/Busbar
Pollution degree		2
Reference temperature for setting of thermal element(℃)		30
Storage temperature(℃)		-25℃ ~+70℃
Tightening torque		3.0
Connection		Top
Dimensions(mm) (WxHxL)		
	a(1P+N)	54
	b(1P+N)	77.5
	c(1P+N)	105.5
Weight(kg)	1P+N	323

■ Default □ Optional - None

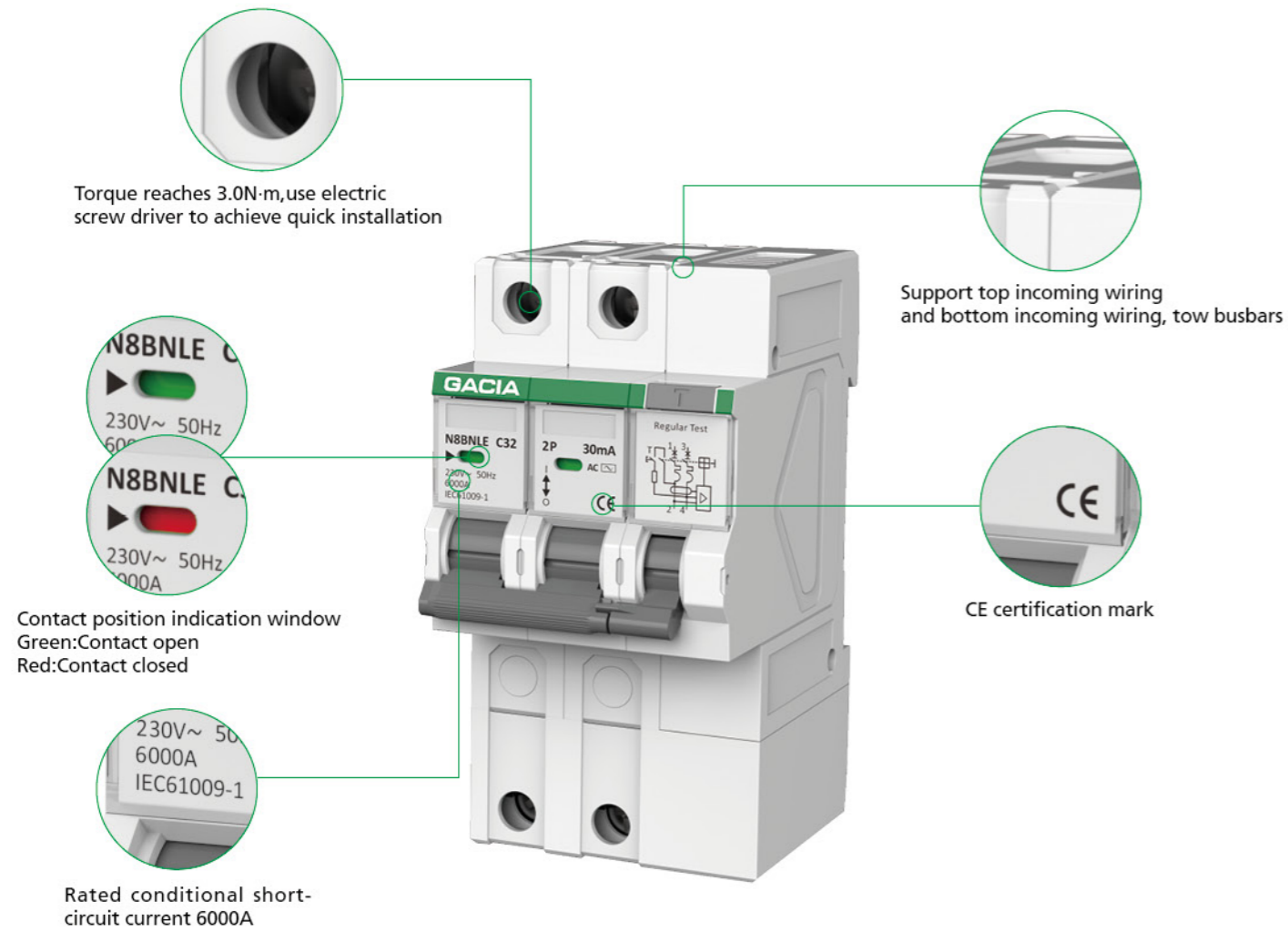

Normal Working Conditions and Installation Conditions:



- ◆ Ambient Temperature: -5°C ~+40°C
- ◆ Height above Sea Level: ≤ 2000m.
- ◆ Installation Category: II, III
- ◆ Pollution Degree: 2
- ◆ The installation type adopts standard steel guide rail installation (TH35-7.5).
- ◆ Installation Conditions: The external magnetic field of the installation site shall not exceed 5 -times of the earth's magnetic field in any direction. When over voltage residual current moves, the circuit breaker shall be installed vertically, and the upward position of the handle shall be connected to the power. The installation should be free from obvious impact and vibration.
- ◆ Mode of Connection: Use screws to press the wiring.

Characteristics Curve

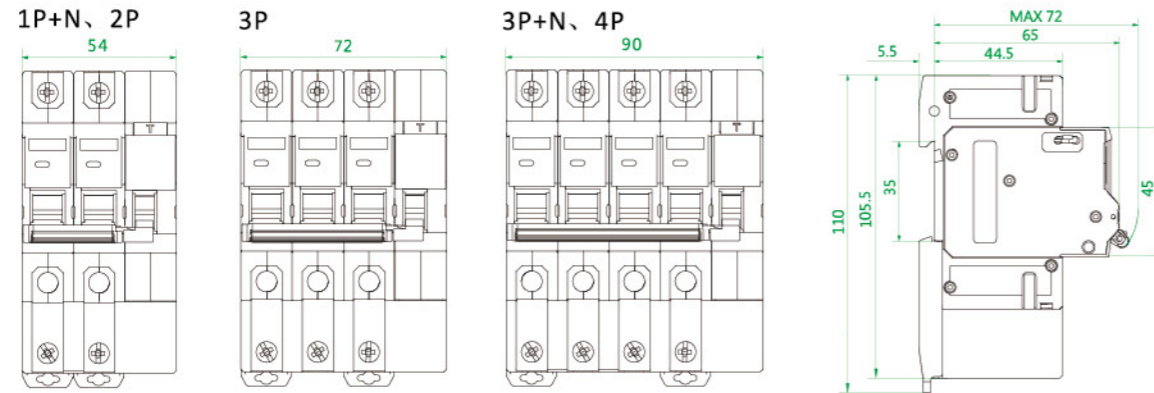

◆ N8BNLE/N8BLE

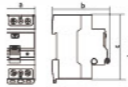

Model		N8LGM
IEC/EN 61008-1		
Poles		2P, 4P
Certification		
Electrical Specification		
Rated current(A)	I_n	16-100
Rated working voltage(V)	U_e	2P:230,4P:400
Rated insulated voltage(V)	U_i	500
Impulse withstand voltage(kV)	U_{imp}	6
Rated conditional short-circuit current	I_{nc}	10
Rated Residual current(mA)	$I_{\Delta n}$	10,30,100,300
Rated Residual making and breaking capacity	$I_{\Delta m}$	1000
Residual current working type		AC,A
Residual current Protection type		Electromagnetic
Dielectric test voltage(kV)		2.5
Service life	Mechanical Standard value	4000
(O-C)	Electrical Standard value	2000
Control And Indication		
Shunt release(SHT)		-
Undervoltage release(UVT)		-
Auxiliary contact(AUX)		-
Alarm contact(ALT)		-
Contact position indicator		■
Fault indication		■
Connection And Installation		
Ambient temperature(with daily average $\leq 35^\circ\text{C}$)		$-5^\circ\text{C} \sim +40^\circ\text{C}$
Protection degree	ALL Sides	IP40
	Connection Terminal	IP20
Wire(mm ²)		35
busbar(mm ²)		35
Mounting		Cable/Busbar
Reference temperature for setting of thermal element		30
Pollution degree		2
Storage temperature (°C)		$-25^\circ\text{C} \sim +70^\circ\text{C}$
Connection		Top and bottom
Dimensions(mm)		a(1P+N)
(WxHxL)		b(1P+N)
		c(1P+N)
Weight(kg)		2P
		4P

■ Default □ Optional - None

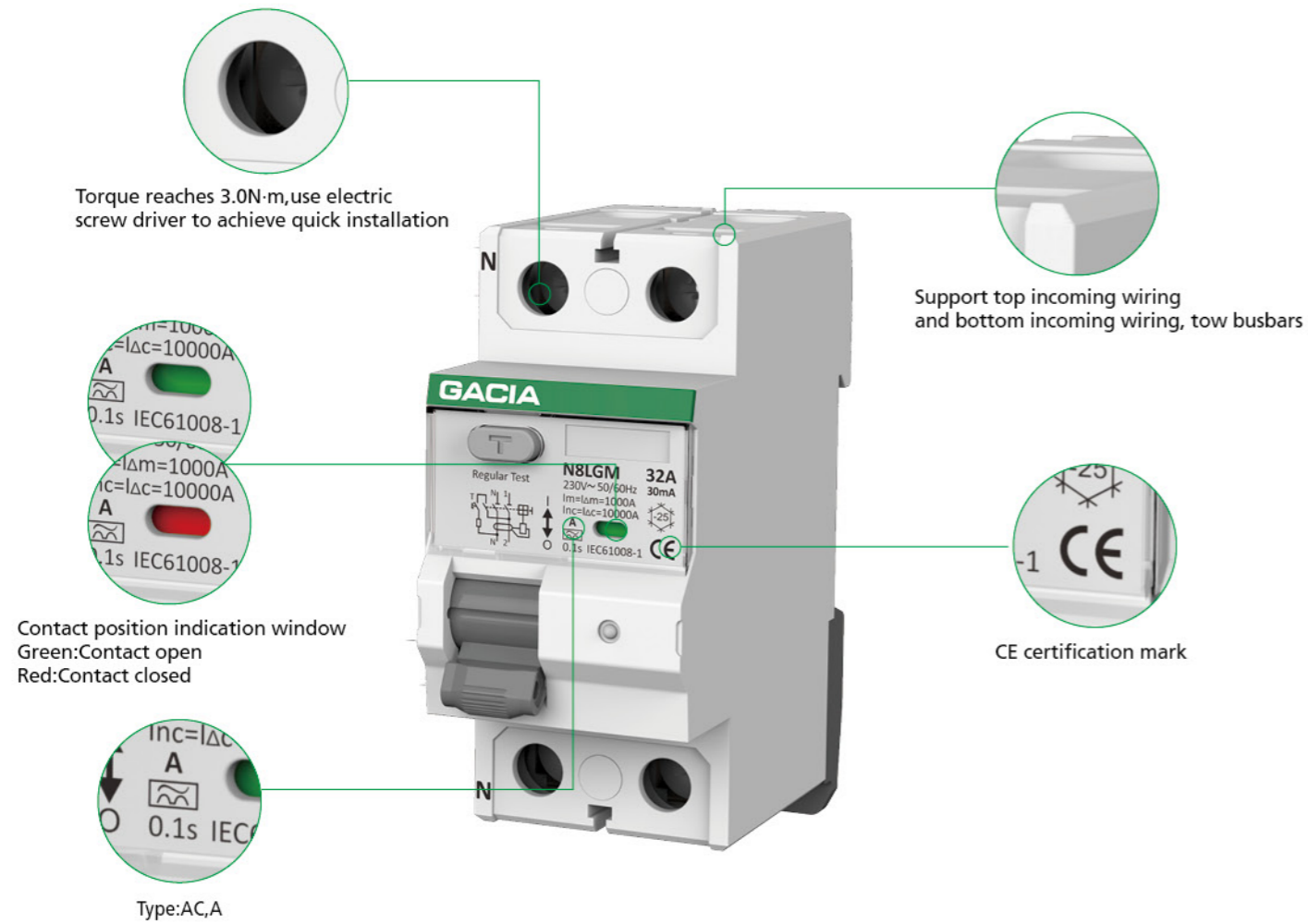

Normal Working Conditions and Installation Conditions:

- ◆ Ambient Temperature: -5°C ~+40°C
- ◆ Height above Sea Level: ≤ 2000m.
- ◆ Installation Category: II, III
- ◆ Pollution Degree: 2
- ◆ The installation type adopts standard steel guide rail installation (TH35-7.5).
- ◆ Installation Conditions: The external magnetic field of the installation site shall not exceed 5 -times of the earth's magnetic field in any direction. When over voltage residual current moves, the circuit breaker shall be installed vertically, and the upward position of the handle shall be connected to the power. The installation should be free from obvious impact and vibration.
- ◆ Mode of Connection: Use screws to press the wiring.

◆ N8LGM

