

ASG-DN5127-A

Single Standard Series 27W | 500mA 45-54V DC

SPECIFICATION.

Symbol	Parameter	Condition	Min	Type	Max	Unit
Vin	Input Voltage Range	50/60 HZ	100	110/220	240	VAC
Pi	Input Power Range			31.2		W
Vo	Output Voltage Range	LED2W 12-14 series	45	54	57	VDC
Io	Output Current			500		mA
Po	Output Power			27		W
PF	Power Factor	Vi=110/220VAC		≥ 0.9		
Vis	Isolation Pressure Resistance	Input to output, the environmental humidity is less than 99%, unsaturated.	3.75			KV
Δi	Constant Current Accuracy	Working environment temperature is -15°C ~ +50°C	-5		5	%
λ	Output Efficiency			86		%
TA	Temperature of Working Environment		-15		50	°C
Voc	Open-circuit Voltage	No-Load		≤ 35		
Ton	Start Time			≤ 2		mS
Receive	Reception Sensitivity	50 ohm antenna direct input/1K Kbps	-109	-110	-111	dB
Fc	Working Frequency		433.82	433.92	434.02	MHZ
	Modulation mode GASK					

LIMIT PARAMETER.

Symbol	Parameter	Min	Type	Max	Unit
Vin	Input Voltage Range	100	110/220	240	VAC
Vo	Output Voltage Range	45	54	57	VDC
λ	Input Power		31.2		W
TA	Temperature of Working Environment	-20		55	°C

RELATIVE STANDARDS.

Safety Standards	IEC 61347-2-13:2006 IEC 61347-1:2007+A1:2010+A2:2012 EN 61347-2-13:2006 EN 61347-1:2008+A1:2011+A2:2013 EN 62493:2010
EMI/EMC Standards	IEC 61547:2009+IS1:2013 EC 61000-3-2:2006+A1:2008+A2:2009 EN 55015:2006+A1:2007+A2:2009 EN 61547:2009 EN 61000-3-2:2006+A1:2009+A2:2009 EN 61000-3-3:2008 IEC 61000-3-3:2008 CISPR 15:2011

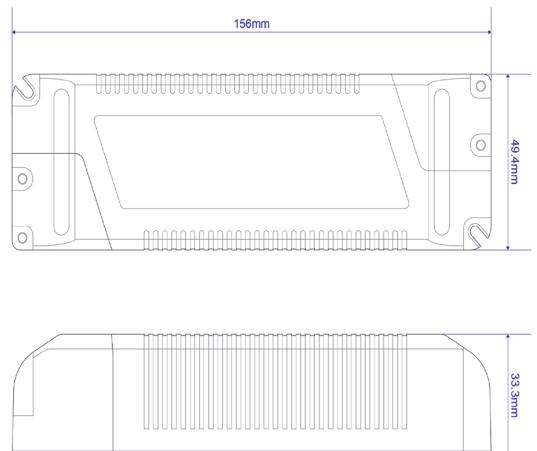

ASG-DN5127-B

Single Standard Series 27W | 700mA 28-38V DC

SPECIFICATION.

Symbol	Parameter	Condition	Min	Type	Max	Unit
Vin	Input Voltage Range	50/60 HZ	100	110/220	240	VAC
Pi	Input Power Range			31.2		W
Vo	Output Voltage Range	LED3W 7-9 series	28	38	41	VDC
Io	Output Current			700		mA
Po	Output Power			27		W
PF	Power Factor	Vi=110/220VAC		≥ 0.9		
Vis	Isolation Pressure Resistance	Input to output, the environmental humidity is less than 99%, unsaturated.	3.75			KV
Δi	Constant Current Accuracy	Working environment temperature is -15°C ~ +50°C	-5		5	%
λ	Output Efficiency			86		%
TA	Temperature of Working Environment		-15		50	°C
Voc	Open-circuit Voltage	No-Load		≤ 35		
Ton	Start Time			≤ 2		mS
Receive	Reception Sensitivity	50 ohm antenna direct input/1K Kbps	-109	-110	-111	dB
Fc	Working Frequency		433.82	433.92	434.02	MHZ
	Modulation mode GASK					

LIMIT PARAMETER.

Symbol	Parameter	Min	Type	Max	Unit
Vin	Input Voltage Range	100	110/220	240	VAC
Vo	Output Voltage Range	28	38	41	VDC
λ	Input Power		31.2		W
TA	Temperature of Working Environment	-20		55	°C

RELATIVE STANDARDS.

Safety Standards	IEC 61347-2-13:2006 IEC 61347-1:2007+A1:2010+A2:2012 EN 61347-2-13:2006 EN 61347-1:2008+A1:2011+A2:2013 EN 62493:2010
EMI/EMC Standards	IEC 61547:2009+IS1:2013 EC 61000-3-2:2006+A1:2008+A2:2009 EN 55015:2006+A1:2007+A2:2009 EN 61547:2009 EN 61000-3-2:2006+A1:2009+A2:2009 EN 61000-3-3:2008 IEC 61000-3-3:2008 CISPR 15:2011

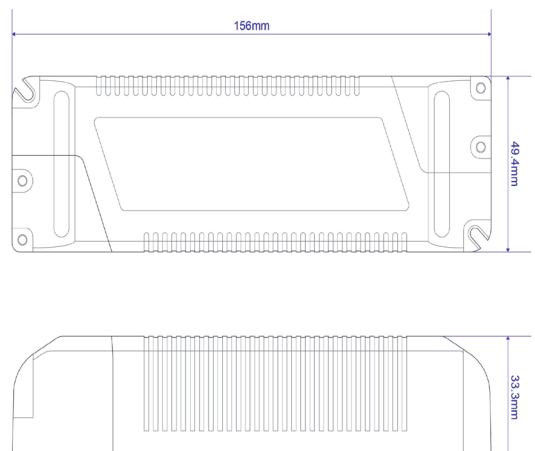

ASG-DN5127-C

Single Standard Series 27W | 1050mA 18-26V DC

SPECIFICATION.

Symbol	Parameter	Condition	Min	Type	Max	Unit
Vin	Input Voltage Range	50/60 HZ	100	110/220	240	VAC
Pi	Input Power Range			31.2		W
Vo	Output Voltage Range	LED2W 5-7 series 2 parallel	18	26	29	VDC
Io	Output Current			1050		mA
Po	Output Power			27		W
PF	Power Factor	Vi=110/220VAC		≥ 0.9		
Vis	Isolation Pressure Resistance	Input to output, the environmental humidity is less than 99%, unsaturated.	3.75			KV
Δi	Constant Current Accuracy	Working environment temperature is -15°C ~ +50°C	-5		5	%
λ	Output Efficiency			86		%
TA	Temperature of Working Environment		-15		50	°C
Voc	Open-circuit Voltage	No-Load		≤ 35		
Ton	Start Time			≤ 2		mS
Receive	Reception Sensitivity	50 ohm antenna direct input/1K Kbps	-109	-110	-111	dB
Fc	Working Frequency		433.82	433.92	434.02	MHZ
	Modulation mode GASK					

LIMIT PARAMETER.

Symbol	Parameter	Min	Type	Max	Unit
Vin	Input Voltage Range	100	110/220	240	VAC
Vo	Output Voltage Range	18	26	29	VDC
λ	Input Power		31.2		W
TA	Temperature of Working Environment	-20		55	°C

RELATIVE STANDARDS.

Safety Standards	IEC 61347-2-13:2006 IEC 61347-1:2007+A1:2010+A2:2012 EN 61347-2-13:2006 EN 61347-1:2008+A1:2011+A2:2013 EN 62493:2010
EMI/EMC Standards	IEC 61547:2009+IS1:2013 EC 61000-3-2:2006+A1:2008+A2:2009 EN 55015:2006+A1:2007+A2:2009 EN 61547:2009 EN 61000-3-2:2006+A1:2009+A2:2009 EN 61000-3-3:2008 IEC 61000-3-3:2008 CISPR 15:2011

