

ASG-DN5115-A

Single Standard Series 15W | 350mA 35-45V DC

SPECIFICATION.

Symbol	Parameter	Condition	Min	Type	Max	Unit
Vin	Input Voltage Range	50/60 HZ	100	110/220	240	VAC
Pi	Input Power Range			17.1		W
Vo	Output Voltage Range	LED1W 12-15 series	35	45	47	VDC
Io	Output Current			350		mA
Po	Output Power			15		W
PF	Power Factor	Vi=110/220VAC		≥ 0.9		
Vis	Isolation Pressure Resistance	Input to output, the environmental humidity is less than 99%, unsaturated.	3.75			KV
Δi	Constant Current Accuracy	Working environment temperature is -15°C ~ +50°C	-5		5	%
λ	Output Efficiency			87		%
TA	Temperature of Working Environment		-15		50	°C
Voc	Open-circuit Voltage	No-Load		≤ 35		
Ton	Start Time			≤ 2		mS
Receive	Reception Sensitivity	50 ohm antenna direct input/1K Kbps	-109	-110	-111	dB
Fc	Working Frequency		433.82	433.92	434.02	MHZ
	Modulation mode GASK					

LIMIT PARAMETER.

Symbol	Parameter	Min	Type	Max	Unit
Vin	Input Voltage Range	100	110/220	240	VAC
Vo	Output Voltage Range	35	45	47	VDC
λ	Input Power		17.1		W
TA	Temperature of Working Environment	-20		55	°C

RELATIVE STANDARDS.

Safety Standards	IEC 61347-2-13:2006 IEC 61347-1:2007+A1:2010+A2:2012 EN 61347-2-13:2006 EN 61347-1:2008+A1:2011+A2:2013 EN 62493:2010
EMI/EMC Standards	IEC 61547:2009+IS1:2013 EC 61000-3-2:2006+A1:2008+A2:2009 EN 55015:2006+A1:2007+A2:2009 EN 61547:2009 EN 61000-3-2:2006+A1:2009+A2:2009 EN 61000-3-3:2008 IEC 61000-3-3:2008 CISPR 15:2011

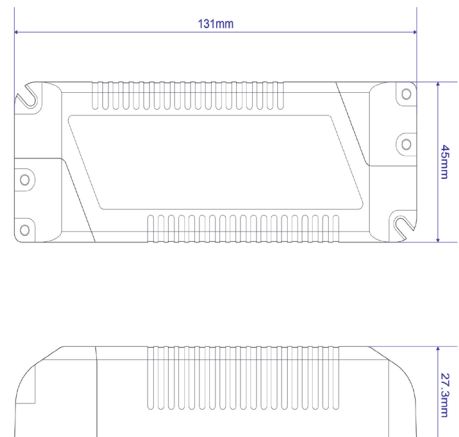

ASG-DN5115-B

Single Standard Series 15W | 550mA 18-28V DC

SPECIFICATION.

Symbol	Parameter	Condition	Min	Type	Max	Unit
Vin	Input Voltage Range	50/60 HZ	100	110/220	240	VAC
Pi	Input Power Range			17.1		W
Vo	Output Voltage Range	LED2W 6-9 series	18	28	31	VDC
Io	Output Current			550		mA
Po	Output Power			15		W
PF	Power Factor	Vi=110/220VAC		≥ 0.9		
Vis	Isolation Pressure Resistance	Input to output, the environmental humidity is less than 99%, unsaturated.	3.75			KV
Δi	Constant Current Accuracy	Working environment temperature is -15°C ~ +50°C	-5		5	%
λ	Output Efficiency			85		%
TA	Temperature of Working Environment		-15		50	°C
Voc	Open-circuit Voltage	No-Load		≤ 35		
Ton	Start Time			≤ 2		mS
Receive	Reception Sensitivity	50 ohm antenna direct input/1K Kbps	-109	-110	-111	dB
Fc	Working Frequency		433.82	433.92	434.02	MHZ
	Modulation mode GASK					

LIMIT PARAMETER.

Symbol	Parameter	Min	Type	Max	Unit
Vin	Input Voltage Range	100	110/220	240	VAC
Vo	Output Voltage Range	18	28	31	VDC
λ	Input Power		17.1		W
TA	Temperature of Working Environment	-20		55	°C

RELATIVE STANDARDS.

Safety Standards	IEC 61347-2-13:2006 IEC 61347-1:2007+A1:2010+A2:2012 EN 61347-2-13:2006 EN 61347-1:2008+A1:2011+A2:2013 EN 62493:2010
EMI/EMC Standards	IEC 61547:2009+IS1:2013 EC 61000-3-2:2006+A1:2008+A2:2009 EN 55015:2006+A1:2007+A2:2009 EN 61547:2009 EN 61000-3-2:2006+A1:2009+A2:2009 EN 61000-3-3:2008 IEC 61000-3-3:2008 CISPR 15:2011

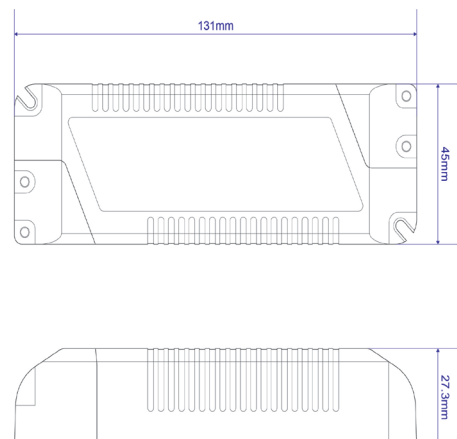

ASG-DN5115-C

Single Standard Series 15W | 700mA 12-22V DC

SPECIFICATION.

Symbol	Parameter	Condition	Min	Type	Max	Unit
Vin	Input Voltage Range	50/60 HZ	100	110/220	240	VAC
Pi	Input Power Range			17.1		W
Vo	Output Voltage Range	LED3W 4-7 series	12	22	25	VDC
Io	Output Current			700		mA
Po	Output Power			15		W
PF	Power Factor	Vi=110/220VAC		≥ 0.9		
Vis	Isolation Pressure Resistance	Input to output, the environmental humidity is less than 99%, unsaturated.	3.75			KV
Δi	Constant Current Accuracy	Working environment temperature is -15°C ~ +50°C	-5		5	%
λ	Output Efficiency			85		%
TA	Temperature of Working Environment		-15		50	°C
Voc	Open-circuit Voltage	No-Load		≤ 35		
Ton	Start Time			≤ 2		mS
Receive	Reception Sensitivity	50 ohm antenna direct input/1K Kbps	-109	-110	-111	dB
Fc	Working Frequency		433.82	433.92	434.02	MHZ
	Modulation mode GASK					

LIMIT PARAMETER.

Symbol	Parameter	Min	Type	Max	Unit
Vin	Input Voltage Range	100	110/220	240	VAC
Vo	Output Voltage Range	12	22	25	VDC
λ	Input Power		17.1		W
TA	Temperature of Working Environment	-20		55	°C

RELATIVE STANDARDS.

Safety Standards	IEC 61347-2-13:2006 IEC 61347-1:2007+A1:2010+A2:2012 EN 61347-2-13:2006 EN 61347-1:2008+A1:2011+A2:2013 EN 62493:2010
EMI/EMC Standards	IEC 61547:2009+IS1:2013 EC 61000-3-2:2006+A1:2008+A2:2009 EN 55015:2006+A1:2007+A2:2009 EN 61547:2009 EN 61000-3-2:2006+A1:2009+A2:2009 EN 61000-3-3:2008 IEC 61000-3-3:2008 CISPR 15:2011

