

ASG-DI5155-A

Single Dimming Series 55W | 660mA 65-75V DC

SPECIFICATION.

Symbol	Parameter	Condition	Min	Type	Max	Unit
V _{in}	Input Voltage Range	50/60 HZ	100	110/220	240	VAC
P _i	Input Power Range			63.3		W
V _o	Output Voltage Range	LED3W 17-18 series	65	75	78	VDC
I _o	Output Current			660		mA
P _o	Output Power			55		W
PF	Power Factor	V _i =110/220VAC		≥ 0.9		
V _{is}	Isolation Pressure Resistance	Input to output, the environmental humidity is less than 99%, unsaturated.	3.75			KV
Δi	Constant Current Accuracy	Working environment temperature is -15°C~ +50°C	-5		5	%
λ	Output Efficiency			86		%
T _A	Temperature of Working Environment		-15		50	°C
V _{oc}	Open-circuit Voltage	No-Load		≤ 35		
T _{on}	Start Time			≤ 2		mS
Dimming	Dimming Way	PWM 0-100% smooth and no jitter	0-100	3-100	6-100	%
Receive	Reception Sensitivity	50 ohm antenna direct input/1K Kbps	-109	-110	-111	dB
F _c	Working Frequency		433.82	433.92	434.02	MHZ
	Modulation mode GASK					

LIMIT PARAMETER.

Symbol	Parameter	Min	Type	Max	Unit
V _{in}	Input Voltage Range	100	110/220	240	VAC
V _o	Output Voltage Range	65	75	78	VDC
λ	Input Power		63.3		W
T _A	Temperature of Working Environment	-20		55	°C

RELATIVE STANDARDS.

Safety Standards	IEC 61347-2-13:2006 IEC 61347-1:2007+A1:2010+A2:2012 EN 61347-2-13:2006 EN 61347-1:2008+A1:2011+A2:2013 EN 62493:2010
EMI/EMC Standards	IEC 61547:2009+IS1:2013 EC 61000-3-2:2006+A1:2008+A2:2009 EN 55015:2006+A1:2007+A2:2009 EN 61547:2009 EN 61000-3-2:2006+A1:2009+A2:2009 EN 61000-3-3:2008 IEC 61000-3-3:2008 CISPR 15:2011

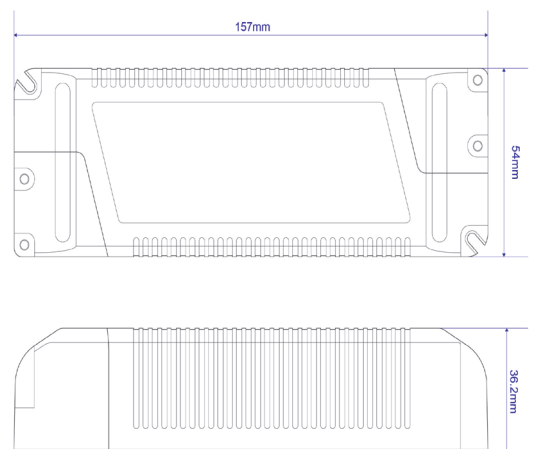

ASG-DI5155-B

Single Dimming Series 55W | 900mA 46-54V DC

SPECIFICATION.

Symbol	Parameter	Condition	Min	Type	Max	Unit
V _{in}	Input Voltage Range	50/60 HZ	100	110/220	240	VAC
P _i	Input Power Range			63.3		W
V _o	Output Voltage Range	LED2W 12-14 series 2 parallel	46	54	57	VDC
I _o	Output Current			900		mA
P _o	Output Power			55		W
PF	Power Factor	V _i =110/220VAC		≥ 0.9		
V _{is}	Isolation Pressure Resistance	Input to output, the environmental humidity is less than 99%, unsaturated.	3.75			KV
Δi	Constant Current Accuracy	Working environment temperature is -15°C~ +50°C	-5		5	%
λ	Output Efficiency			86		%
T _A	Temperature of Working Environment		-15		50	°C
V _{oc}	Open-circuit Voltage	No-Load		≤ 35		
T _{on}	Start Time			≤ 2		mS
Dimming	Dimming Way	PWM 0-100% smooth and no jitter	0-100	3-100	6-100	%
Receive	Reception Sensitivity	50 ohm antenna direct input/1K Kbps	-109	-110	-111	dB
F _c	Working Frequency		433.82	433.92	434.02	MHZ
	Modulation mode GASK					

LIMIT PARAMETER.

Symbol	Parameter	Min	Type	Max	Unit
V _{in}	Input Voltage Range	100	110/220	240	VAC
V _o	Output Voltage Range	46	54	57	VDC
λ	Input Power		63.3		W
T _A	Temperature of Working Environment	-20		55	°C

RELATIVE STANDARDS.

Safety Standards	IEC 61347-2-13:2006 IEC 61347-1:2007+A1:2010+A2:2012 EN 61347-2-13:2006 EN 61347-1:2008+A1:2011+A2:2013 EN 62493:2010
EMI/EMC Standards	IEC 61547:2009+IS1:2013 EC 61000-3-2:2006+A1:2008+A2:2009 EN 55015:2006+A1:2007+A2:2009 EN 61547:2009 EN 61000-3-2:2006+A1:2009+A2:2009 EN 61000-3-3:2008 IEC 61000-3-3:2008 CISPR 15:2011

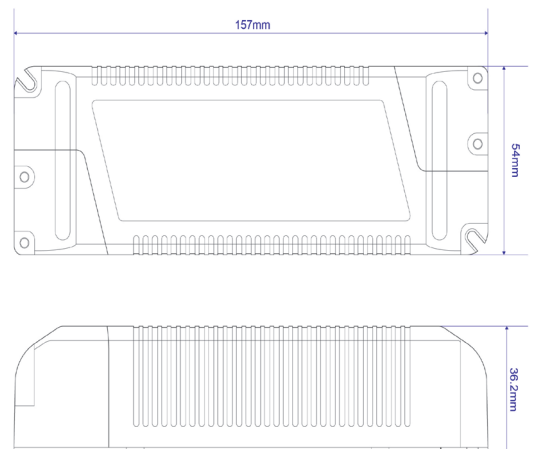

ASG-DI5155-C

Single Dimming Series 55W | 1400mA 28-38V DC

SPECIFICATION.

Symbol	Parameter	Condition	Min	Type	Max	Unit
V _{in}	Input Voltage Range	50/60 HZ	100	110/220	240	VAC
P _i	Input Power Range			63.3		W
V _o	Output Voltage Range	LED3W 9-10 series 2 parallel	28	38	41	VDC
I _o	Output Current			1400		mA
P _o	Output Power			55		W
PF	Power Factor	V _i =110/220VAC		≥ 0.9		
V _{is}	Isolation Pressure Resistance	Input to output, the environmental humidity is less than 99%, unsaturated.	3.75			KV
Δi	Constant Current Accuracy	Working environment temperature is -15°C~ +50°C	-5		5	%
λ	Output Efficiency			86		%
T _A	Temperature of Working Environment		-15		50	°C
V _{oc}	Open-circuit Voltage	No-Load		≤ 35		
T _{on}	Start Time			≤ 2		mS
Dimming	Dimming Way	PWM 0-100% smooth and no jitter	0-100	3-100	6-100	%
Receive	Reception Sensitivity	50 ohm antenna direct input/1K Kbps	-109	-110	-111	dB
F _c	Working Frequency		433.82	433.92	434.02	MHZ
	Modulation mode GASK					

LIMIT PARAMETER.

Symbol	Parameter	Min	Type	Max	Unit
V _{in}	Input Voltage Range	100	110/220	240	VAC
V _o	Output Voltage Range	28	38	41	VDC
λ	Input Power		63.3		W
T _A	Temperature of Working Environment	-20		55	°C

RELATIVE STANDARDS.

Safety Standards	IEC 61347-2-13:2006 IEC 61347-1:2007+A1:2010+A2:2012 EN 61347-2-13:2006 EN 61347-1:2008+A1:2011+A2:2013 EN 62493:2010
EMI/EMC Standards	IEC 61547:2009+IS1:2013 EC 61000-3-2:2006+A1:2008+A2:2009 EN 55015:2006+A1:2007+A2:2009 EN 61547:2009 EN 61000-3-2:2006+A1:2009+A2:2009 EN 61000-3-3:2008 IEC 61000-3-3:2008 CISPR 15:2011

