

# Technical Manual

SL/DC Series

VALVE REGULATED LEAD-ACID BATTERY



Shenzhen UPSen Electric CO., Ltd.

## Contents

Item	Page
Prolegomenon	1
1 Application Range	1
2 Check	1
3 Storage before Installation	2
4 Installation Cautions	2
5 Battery Installation	3
6 Installation Demonstration	3
7 Battery Features	4
8 Operating Principle	4
9 Battery Charge, Discharge & Life	5
10 Record	8
11 Maintenance	8
12 Common Faults & Solutions	9
13 Installation Drawing	10





# Prolegomenon

In order to install and use UPSEN VRLA battery correctly and safely, please read this technical manual and other data together with battery carefully for a comprehensive understanding.

★Pay attention to safety during installation to avoid accident.

★It is required for users to read this manual carefully and keep it well.

★If you have any questions about the Technical Manual or any technical problems, please contact us or our local agent.

Dangerous!				
	 			
High Voltage…… Don't touch any terminals or connectors without insulation to avoid electric shock.	Eyes Protection: Gas from explosion may harm eyes or even cause blindness.	Prohibition: Sparks, fire and smoking.	Vitriol: May cause blindness or severe burns.	Wash eyes with clean water immediately and go to see a doctor.
Do not loosen the safety vales.		Keep the battery in a well ventilated environment when in operation.		
Please read carefully the installing and using instructions in this manual.		Battery maintenance and repair should be conducted by experienced technicians.		

## 1 Application Range

This manual is applied to UPSEN SL,DC series battery (hereafter referred to as battery).

## 2 Check

1. After receiving the batteries, please check the packing and make sure the batteries are intact. Avoid bumping during carrying, and be careful when open the cartons.
2. Please open the cartons near the installation place and check appearance and quantity of the battery accessories after opening.
3. It's difficult to detect leakage if there are slight damages on the battery shell. Please check carefully and make sure there is no damage or leakage on the battery shell.
4. If the battery falls to the ground or its shell is bumped abnormally, please report the details to our company for confirmation and aftermath arrangement.

### 3 Storage before Installation

#### 1. Storage Environment

If the battery is not installed immediately after being received, please store it in a clean, ventilated and dark place at around 5~30°C.

#### 2. Storage Time

Due to self-discharge, the battery capacity will lose gradually in storage. Do not store the battery for more than 12 months or it will affect the battery performance eternally. After being stored for 6 months, the battery should be charged in voltage of  $2.35 \pm 0.02V$  for 24 hours and hereafter should be recharged at least once every 6 months. A relatively high temperature will accelerate the battery self-discharge; from 20°C when the temperature increases every 10°C, recharging interval should be reduced half. For example, when the battery is stored at 35°C, its initial charging or recharging interval should be 3 months.

If the battery is not charged properly, its performance and life will be affected and cause the normal guarantee invalid.

### 4 Installation Cautions

1. Before touching the battery, please wear a rubber apron, rubber gloves, safety goggles or other eyes protection equipments; do not wear metal objects, such as jewelry etc.
2. The battery is very heavy. Be careful and do not pump the battery when moving it.
3. Smoking or lighting fires are strictly forbidden. Keep the battery away from electric arc.
4. Avoid short circuit. The battery has been charged and please prevent battery from short circuit to avoid equipment damage or personal injury.
5. Put the battery in a cool and well ventilated place. Do not install the battery in a place that is possible to be immersed by water.
6. Fix the bolts and nuts on the connection terminals to the specified torque; otherwise it may cause sparks or damages to the terminals.
7. Please clean the battery shell and cover with a wet cloth; to prevent static and spark, do not use a duster or a dry cloth to clean the battery. It's prohibited to use organic solvent such as rubber solution or naphtha, which will cause the battery shell cracking.
8. In normal operation, there will be no dissociative electrolyte attached on the shell after battery gets fully sealed. However, if the battery shell is damaged, dissociative vitriol is possible to leak. In case electrolyte splashes onto eyes, skin or clothes, flush it with a large quantity of water. If it splashes into eyes, after rinsing with water, please go to see a doctor promptly.
9. Make sure the positive (+/red) and negative (-/black) terminals are connected properly, otherwise it will cause fire or damages to the battery or charger.
10. Please use the following protection equipments when you carry, install and maintain the battery.
  - 1) Safety goggles or protective face-shield;
  - 2) Acid-resistant gloves;
  - 3) Acid-resistant apron, safety shoes;
  - 4) Proper carrying instruments;
  - 5) Insulation instruments.

11. Battery posts, terminals and fittings contain lead or lead compound; and other chemical compositions in the battery are harmful to personal health.

Wash your hands after touching the battery!

## 5 Battery Installation

1. Install the battery according to installation drawing.  
Please leave at least 1,000mm passageway as maintenance space.
2. Install Connectors  
Apply the Vaseline onto the battery terminals to prevent large resistance oxide; then install connectors. After installing all the battery connectors, make sure all positive (+/red) and negative (-/black) terminals are connected properly according to the installation figures; then fix the connecting screws in the moment of 11.3Nm with a insulative moment spanner.
3. Measure Voltage  
After installing the connectors, measure the total voltage of whole string, which should be the total of the cell voltage. If they are inconsistent, please check the battery polarity and recheck the battery connection in a proper moment.
4. Cell Number  
Stick the self-adhesive labels of cell number and system grade sign on the top of relevant cells.  
The first cell at the positive connecting terminal should be marked as No. 1 and the rest is marked by analogy.
5. Install Battery Shield  
After checking the voltage and arranging the cell numbers, put the shield at the top of the battery.

## 6 Installation Demonstration

1. Fix ground setscrews of the battery shelf rack.
  - 1) Drill screw holes (M8×45mm) on the ground. Make sure the hole location is exact without deviation .
  - 2) Match M8\*60 setscrews and M8 hexagon nuts.
  - 3) Fix the setscrews in the ground holes and leave enough length of screw rod for connecting the battery rack foot.
2. Install battery Side Racks  
Fix the racks into the ground holes.
3. Install beams and batteries of the first shelf.
4. Install beams and batteries of the other shelves.
5. Install connecting wires between batteries and fix all the screws and nuts.
6. Install battery covers and occulting bars.
7. Battery connection
  - 1) If there is oxide on the battery terminals, clean the terminals till they appear metal luster and apply Vaseline evenly on them.
  - 2) Install the connecting strips according to the drawing or under the instruction of technicians. Tighten all the screws and nuts according to the Installation Manual.

## 7 Battery Features

### 1. Long Service Life

Heavy duty lead-calcium grids ensure mild corrosion and enable a long designed service life of 18 years standby use under optimal float charge conditions and below optimal operating temperature of 20°C.

### 2. Excellent and High Efficient Discharge

UPSEN batteries are equipped low resistant plates and conducting parts, which decrease the internal resistance and ensure the highest discharging efficiency.

### 3. Triplex Sealed Construction

Valve regulated sealed construction and triplex strengthened sealing on terminals and posts prevent electrolyte leakage, and guarantee the air tight and liquid tight state of batteries in normal operation and prevent external air from entering battery inner.

### 4. Low Self Discharge

Because of the use of lead-calcium grids alloy, UPSÉN batteries have low self discharge and reliable performance. In room temperature, self discharge ratio per month of UPSÉN battery is about 3% of the battery capacity.

### 5. High Security

UPSÉN batteries are equipped with explosion-proof safety valves to prevent production of redundant gas. And the construction is designed to prevent setting fire to the internal battery in case sparkles approach.

### 6. High Efficiency of Recovery

Unique formulas are used in lead paste of positive post and ensure the battery can be recharged easily to a normal level.

### 7. No Electrolyte Stratification

Special additives are use in electrolyte to give it a gelatinous consistency without flowing, leaking or stratification, and make all parts of plates react evenly.

## 8 Operating Principle

### 1. Electrochemistry

A lead-acid battery is an electrical storage device that converts electrical energy into potential chemical energy; when needed the stored chemical energy can be converted back into electrical energy again to be supplied to external systems. In the discharge state, part of  $PbO_2$  at the positive turns into  $PbSO_4$ , and part of  $Pb$  at the negative also turns into  $PbSO_4$ . In this electro-chemical reaction, both positive and negative electrodes generate  $PbSO_4$ . In the charging state, the lead sulfate ( $PbSO_4$ ) at the positive and negative turns into  $PbO_2$  and  $Pb$ , respectively. When in discharging, the concentration and density of electrolyte  $H_2SO_4$  decreases gradually; while in charging, it increases. Battery charging and discharging are realized by electrochemical reactions.

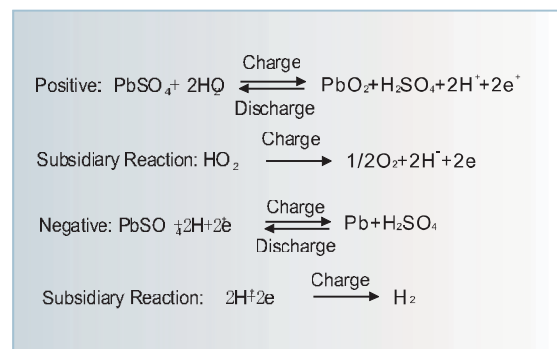

## 2. Oxygen Combination

The positive plate generates oxygen gas in the final stage of charging. Under the condition of excessive additives at the negative, oxygen spreads to the negative plates through separator and reacts with spongy lead and they form lead oxide and then turn into lead sulfate and water. Keep the negative plates in depolarization or undercharge state so that the battery cannot reach the overpotential of oxygen gassing. Thus the battery avoids oxygen gassing and water loss and is a maintenance free sealed storage battery.

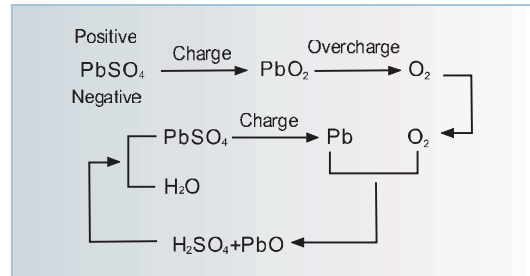

## 9 Battery Charge, Discharge & Life

### 1. Charge Characteristics

Charge condition is one of the important factors in battery use. The battery performance and service life are directly related to its charging methods and charging parameters in using. The battery is recommended to be charged at the temperature range of 5-30°C. At any temperature lower than 5°C or higher than 35°C it will cause undercharge or overheating and then decrease the battery life.

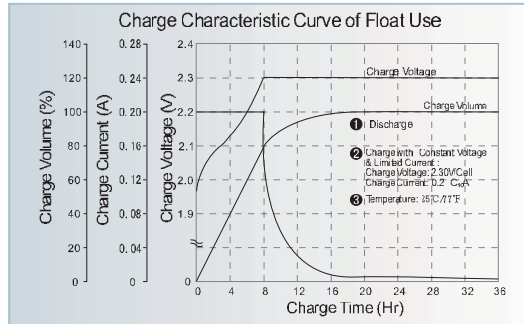

### 2. Charge Curve of Float Use

### 3. Relationship between Float Charge Voltage and Environment Temperature

At general temperature (5°C~30°C), float charge voltage is 2.25V~2.30V. The batteries for float charge service adopt the constant voltage but limited current method. The initial current is  $0.1 C_{10}A$  and the maximum current is  $0.2 C_{10}A$ .

1) At 25°C, the float charge voltage of battery is 2.27V per cell.

2) When the ambient temperature changes, the float charge voltage should be adjusted. The temperature compensation coefficient is  $-3mV/^\circ C$ , i.e.,  $U_{float} = [2.27 - 0.003(t-25)] * n$ .

### 4. Equalize Charge

Equalize charge is required for float service as long time float charge will make some batteries drop behind in the battery bank. An equalize charge can prevent battery stratification and reduce sulfation and bring all cells to similar levels, which is the leading cause of battery failure.

Equalize charge requirements for UPS battery as follows:

✗ Equalize charge 1 time every three months or every 20 discharge cycles.

✗ Equalize charge method: with equalize charge voltage 2.35~2.45Vpc @25°C and max. charge current 0.3CA, and equalize charge time is 12~24h (when the charge current at the end stable about 2~3 hours, stopped equalize and switch to float).

✗ Before equalize charge please let the battery 100% discharged.

### 5. Charge Curve of Cycle Use

The batteries for cycle service adopt the constant voltage but limited current method. At 20°C~25°C, the charge voltage of battery is 2.40V per cell; the initial charge current is not larger than  $0.2 C_{10}A$  and the battery fully charges in approximately 24 hours.

In the final stage of charging, if the charge current value remains unchanged for 3 hours, it indicates that the battery is fully charged.

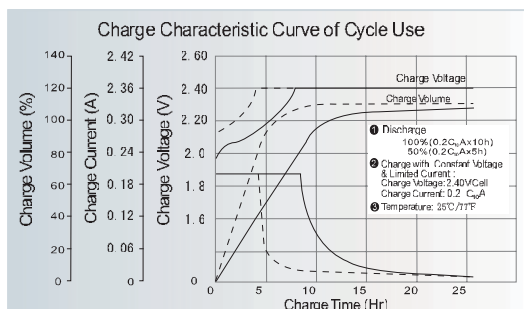

Charge curves are as right.

## 6. Supplementary Charging

Due to self discharge, battery stocked longtime, the capacity reduce slowly, the relationship between capacity reservation, temperature and stock time as right curves.

Supplementary Charging adopts the constant voltage but limited current method.

Charging current is  $0.05 C_{10} - 0.20 C_{10}$ , charging voltage is  $2.35 \pm 0.05V/Cell$ , generally charge for 24~36hours. After long time storage, before use, battery should be makeup charged.

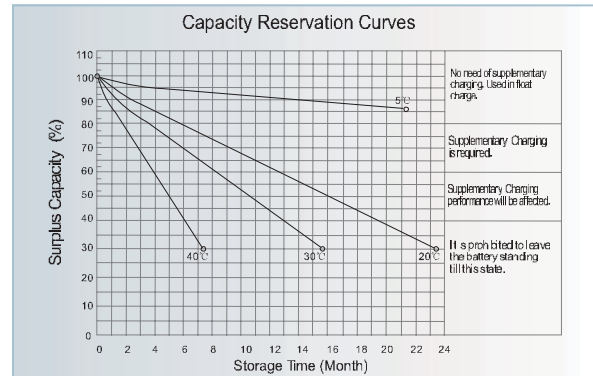

**Storage Time vs Charge Voltage and Charge Time**

Storage Time (Month)	Charge Voltage (V/Cell)	Maximum Charge Current (A)	Maximum Charge Time (Hr)
3~6	2.40	$0.2 C_{10}$	24
6~12	2.40	$0.2 C_{10}$	36

## 7. Discharge Characteristic

Discharge rate is different, the cutoff voltage also different. Higher discharge current, lower cutoff voltage; reversely, lower discharge current, higher cutoff voltage. Normally the battery cutoff voltage set at 1.80 - 1.6V. The discharged capacity is lower with higher discharge current.

Discharge characteristic curves are as right:

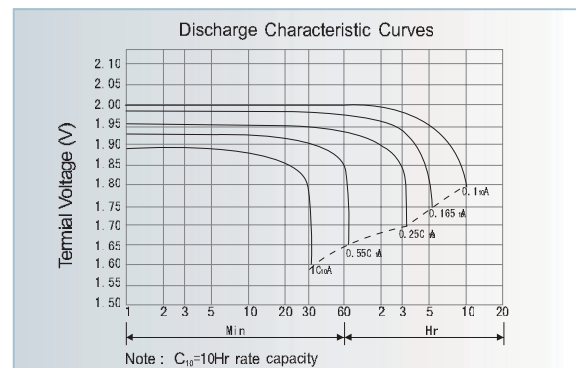

## Discharge Capacity vs Temperature

Battery discharge capacity is related with temperature. Lower temperature, lower capacity discharged; higher temperature, higher capacity discharged. But the too high temperature will seriously damage the battery lifetime. The best working temperature for battery is 20- 25 degree. The discharged capacity at different temperature  $C_t$  vs Discharged capacity at 25 degree  $C_{25}$  have below relationship:

$$C_{25} = \frac{C_t}{1 + K (t - 25)}$$



- C25 Discharged capacity at 25degree (AH)
- Ct Discharged capacity at t°C (AH)
- t Environment temperature during discharge (°C)
- K Temperature compensation coefficient

10Hr rate discharge: K=0.006/°C; 5Hr rate discharge : K=0.007/°C  
 3Hr rate discharge : K=0.008/°C; 1Hr rate discharge : K=0.010/°C

**Temperature vs Capacity Curves as below:**

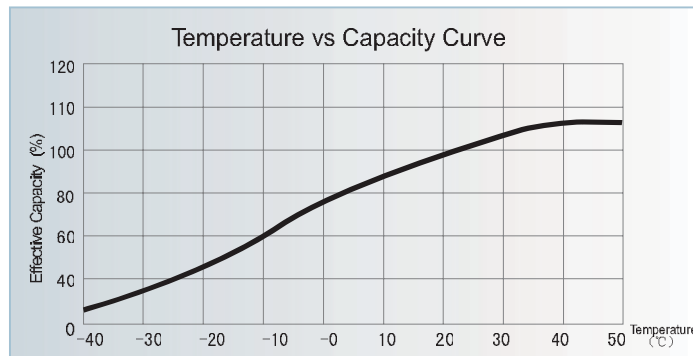

**8. Float Life Characteristic**

At recommended float charging situation at 25degree, battery design life is 12years. Battery’s usage lifetime is related with ambient temperature, depth of discharge, discharge rate and float charging voltage. In real usage, depth of discharge, frequent of discharge, incorrect float charging voltage will effect the battery lifetime directly.

Float Life characteristic curves are as below:

**Float Lifetime vs Temperature**

According to Arrhenius equation, battery design life fluctuated with temperature, temperature increased every 10degree, the float lifetime cut half.

$$\ln \frac{K1}{K2} = \frac{Ea}{R} \left( \frac{1}{T2} - \frac{1}{T1} \right)$$

- K1: Equal constant at T1 temperature
- K2: 1 (Equal constant at T2 temperature)
- Ea: activation energy
- R: air constant, 8.3143J • mole • K-1
- T1: environment temperature at during discharge, K
- T2: standard temperature 293K

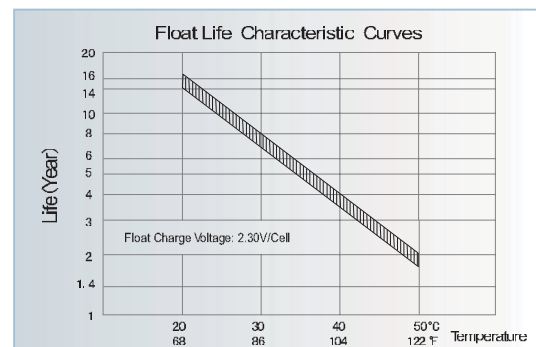

Float Charge Voltage (V)	Battery Actual Float Life at Different Temperature (Year)				
	20°C	25°C	30°C	40°C	50°C
2.30	15.0	10.6	7.5	3.7	1.9

## 10 Record

The operating record of fixed batteries is very important for battery maintenance and protection. This information is useful for user to confirm battery life and adjust the longevity.

Battery is allowed to operate at a temperature lower than 25°C, however, the charging time will be relatively long. After installing batteries and a week of float charge, it's required to record the following information:

- 1) Battery terminal voltage
- 2) Charger voltage
- 3) Float charging voltage of each battery
- 4) Internal resistance of each battery. Within the same battery, put the meter that tests internal resistance at the two terminals that is in farthest diagonal position.
- 5) Environment temperature
- 6) Check if all the connecting points have been fixed to the proper torque (11.3N.M) . Use a milliohmmeter to test internal resistance of each connecting strip. Conduct the test according to the probe position on the instruction manual. If the data range is 20% bigger than that during installation, fix screws again to the torque of 11.3N.M. If the data remains high, please wipe terminals and the interface between terminals and connecting strips.

## 11 Maintenance

Put mask or protective glass when approach battery, make sure not put battery next to fire/ smoking place.

It can prolong battery life and easy to judge when battery need replacement by proper maintenance. If the maintenance way differs from this manual, users can only make the maintenance method according to battery usage and using reliability.

All maintenance needs the professionals to execute.

### 1. Checking

Try to make all checking under float charging conditions. Measurements should be made according to specification from suppliers and keep the records for future collation.

#### 1. 1 Monthly checking

Record for monthly checking:

1. 1. 1 All batteries float charging voltage
1. 1. 2 Current and voltage from charger
1. 1. 3 Temperature, ventilation and monitor equipments situation.
1. 1. 4 Eye check record for battery string:
  - 1) Battery appearance: terminal, connector, any corrosive phenomena with battery rack.
  - 2) The clearance region between batteries and rack
  - 3) Any phenomena of crack or leakage for battery
  - 4) Any phenomena of deformation for battery and rack

#### 1. 2 Quarterly checking

Apart from checking clause of above 12.1 as quarterly checking,

- 1) Resistance per block
- 2) Temperature of negative terminal for each battery
- 3) Check connect resistance at random ( at least check 10% or not less than 6 connectors), if resistance is higher than initial resistance, then need to check all connectors' resistance and dig out reason. (Plz check different connectors each time)

1. 3 Yearly checking and initial checking  
 Apart from checking clause of above 12.1 and 12.2 as yearly checking, plz also checking following issues and keep record ( Need to collate with previous records.)
  - 1) Check all connector resistance ;
  - 2) Try to check AC current and voltage from rectifier.
1. 4 Special checking  
 Batteries need inspection to check if they were get damaged in special situation (like over-discharge, abuse charging machine or charging machine can not work properly ect). The inspection includes all yearly checking clause and make records.
2. Ripple Voltage of rectifier  
 We recommend ripple Voltage of rectifier should not be bigger than 0.5% of charging voltage, and librating ripple time should be shorter than 8 millisecond.
3. Battery cleaning  
 Use water or carbonic acid water to clear battery and cover.
4. Capacity test  
 If batteries can work properly, no need to check capacity. Only to check capacity when doubt battery capacity. Battery cut voltage after discharge should not be lower than suppliers specification.  
 Before capacity testing, make sure battery get fully charged for more than 48 hours under float charge, if not, make a equalization charge for 24 hours then let batteries rest for 8-24 hours.

## 12 Common Faults & Solutions

No.	Common Fault	Solution
1	Leakage	Pls contact the supplier for replacements.
2	Crack	Pls contact the supplier for replacements.
3	Low floating V.	After 24-48hrs equalization charger, still low,
4	Battery less capacity	After 24-48hrs equalization charger, still low,
5	High temp.round pole	Inspect connect point, charger, ventilation and charging current.
6	Abnormal Appearance	Pls contact the supplier for replacements.
7	Grounding Fault	Check leakage or ground faulty.
8	Abnormal connect & inner resistance	Check good connect or charging method.

# 13 Installation Drawing

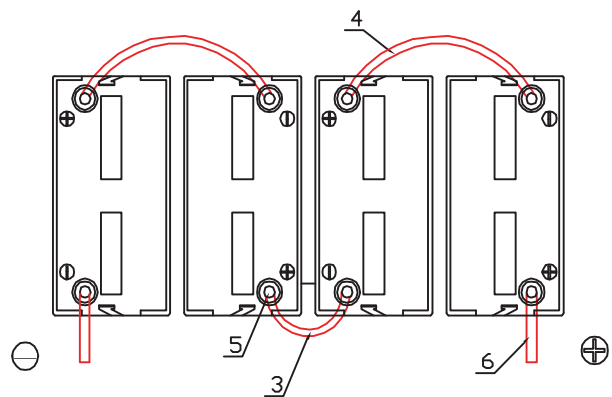
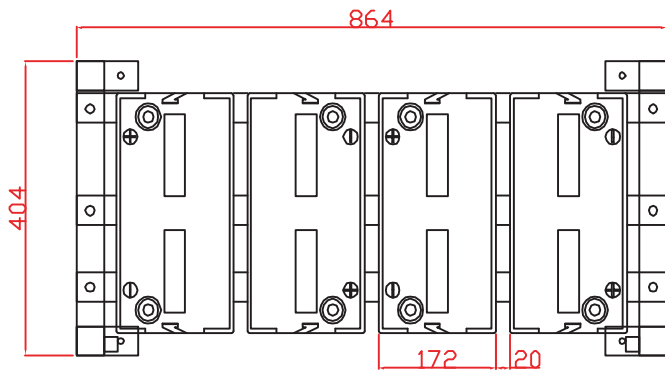
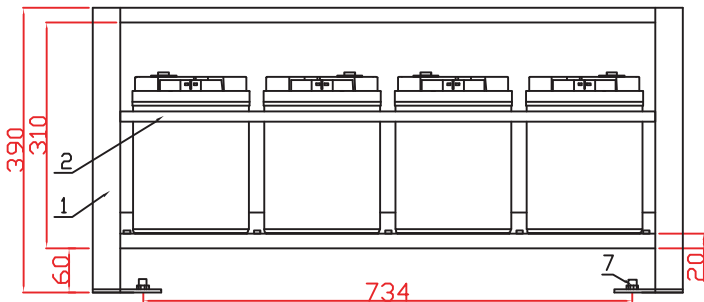

## Technology Requirement:

Pay attention to the positive and the negative of battery when assembled. Please place batteries in terms of our drawings instruction strictly. The gap between two batteries will be 20mm. Please screw the bolts tightly.

7	Bulgy Bolt	M8*60	4							
6	Output Line	200*50mm <sup>2</sup>	2							
5	Bolt	M8*16	8					Including gasket, spring gasket and nut		
4	Soft Connect Line	400*50mm <sup>2</sup>	2							
3	Soft Connect Line	200*50mm <sup>2</sup>	1							
2	SL/DC 12-100 Battery	328*172*222	4							
1	Battery Assembling Rack (48V/SL/DC12-100-00-Z-00)	864*404*390	1							
Series NO.	Title	Specs	Quantity	Material	Single piece	Sum total	Standby			
					Weight					
		Material		Phase Sign	Shenzhen UPSEN Electric CO., LTD.					
0		2009. 04. 18			Series NO.	Quantity	Scale	Quality		
Revision	Mending Version	Date	48V100Ah							
Designed	Technic				Drawing NO.	48V/SL/DC12-100-00-01				
Proof	Standardization									
Checked	Approved				page of					

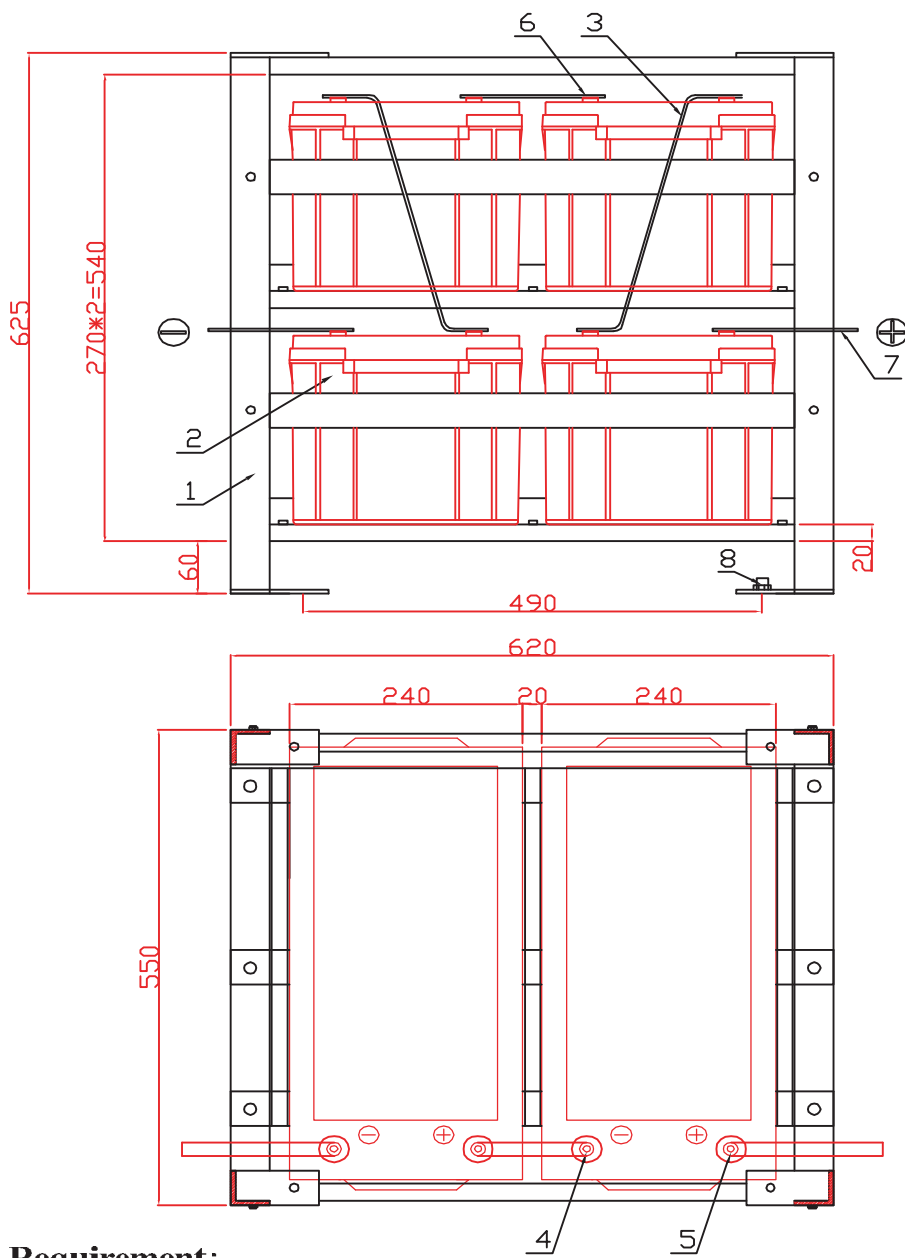

### Technology Requirement:

Pay attention to the positive and the negative of battery when assembled. Please place batteries in terms of our drawings instruction strictly. The gap between two batteries will be 20mm. Please screw the bolts tightly.

8	Bulgy Bolt	M8*60	4						
7	Output Line	500*70mm <sup>2</sup>	2					Copper Nose	
6	Soft Connect Copperplate	120*20*5mm	1						
5	Bolt	M8*20	2					Including gasket, spring gasket and nut	
4	Bolt	M8*16	6					Including gasket, spring gasket and nut	
3	Soft Connect Line	600*70mm <sup>2</sup>	2					Copper Nose	
2	SL/DC12-200 Battery	522*240*224	4						
1	Battery Assembling Rack (48V/SL/DC 12-200-Z-00)	620*550*625	1						
Series NO.	Title	Specs	Quantity	Material	Single piece	Sum total	Standby		
					Weight				
				Material	Phase Sign		Shenzhen UPSEN Electric CO., LTD.		
0		2008. 10. 05			Series NO.	Quantity	Scale	Quality	
Revision	Mending Version	Date							
Designed		Technic							
Proof		Standardization			Drawing NO.	48V/SL/DC12-200-00-01			
Checked		Approved							
				page	of				

48V200Ah

page of

# 14 SL/DC BATTERY CONSTRUCTION

**Figure1 - Construction of 2V Series**

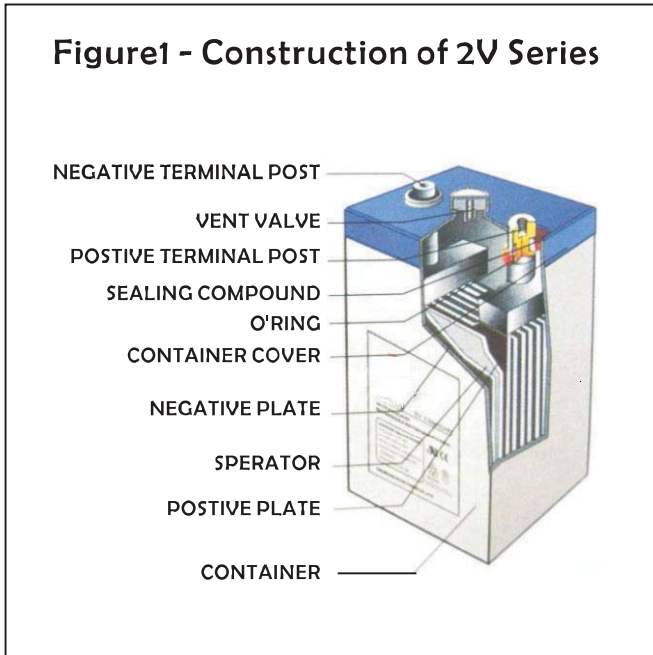

**Figure2 - Construction of 12V Series**

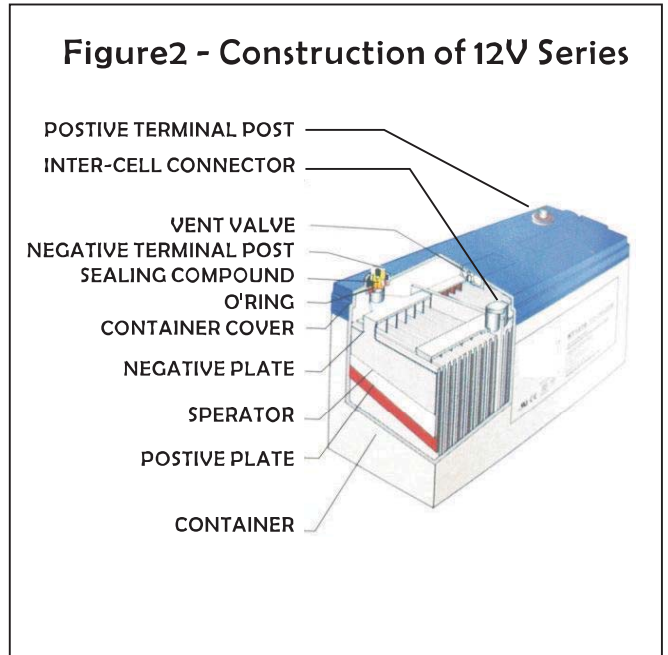

**Table: Show the battery parts and special function**

Battery Parts	Material used	Special Function
Positive and Negative plates	Heavy duty anti-corrosive Lead-calcum alloy gride pasted with active material	<ol style="list-style-type: none"> <li>1. Retain high capacity</li> <li>2. Maintain capacity performance throughout service life</li> <li>3. Minimize self-discharge</li> </ol>
Separator	High density glass fiber	<ol style="list-style-type: none"> <li>1. Prevents short-circuit between (+) and (-) plates</li> <li>2. Prevents active material from shedding</li> <li>3. Retains electrolyte</li> </ol>
Safety valve	Synthetic rubber cap	Release gas if internal pressure rises too high, Operate at 0.07-0.43Kg/cm <sup>3</sup>
Electrolyte	Dilute sulphuric acid fully absorbed by plates & separator	Conduct electro-chemical reaction in (+) and (-) plates
Sealing epoxy	Acud-resistant epoxy resin from Japan	<ol style="list-style-type: none"> <li>1. Sealed construction allow the gas recombination system which transforms the generated gas into water,thus no topping-up is required throughout battery life and is maintenance free</li> <li>2. Leak-proof from terminal of case</li> <li>3. Ensure safety</li> </ol>
Case Components: Container,cover and top lid	Injection-moulded made of ABS plastics resin with UL94HB grade and optionally with UL94V0 grade	<ol style="list-style-type: none"> <li>1. Provides heat-sealed compartment for 2V cell gril groups</li> <li>2. with stands thermal and mechanical shock</li> <li>3. Integral handle incorporated into lid for easy lifting</li> </ol>
Terminal Construction		<ol style="list-style-type: none"> <li>1. Threaded insert terminal provides maximum conductivity and enhance high rate of discharge characteristics</li> </ol>

# 15 MATERIAL SAFETY DATA SHEET

Product Identity: Sealed Maintenance Free Lead-Acid Batteries

## Hazardous Components

Components	%Weight	TLV	Ld50	Lc50	Lc50
			Oral	Inhalation	Contact
Lead(Pb,PbO2,PBSO4)	67-71%	N/A	500mg/lbg	N/A	N/A
Sulfuric Acid	16%	1mg/m3	2120mg/kg	N/A	N/A
Fiberglass Separator	1.5%	N/A	N/A	N/A	N/A
ABS	67-71%	N/A	N/A	N/A	N/A
Others(glue,safety valve, Terminal,O-ring...etc.)	3%	N/A	N/A	N/A	N/A

## Physical Data

Components	Density	Melting Points	Solubility(H2O)	Odor	Appearance
Lead	11.34g/cm3	327.4°C (Boiling)	None	None	Silver-Gray Metal
Lead Sulfate	6.32g/cm3	100+°C (Boiling)	40mg/l(15°C)	None	White Powder
Lead Dioxide	9.37g/cm3	289°C (Boiling)	None	None	Brown Powder
Sulfuric Acid	About 1.3	About 114°C (Boiling)	100%	Acidic	Clear Colorless Liquid
Fiberglass SEP.	135-175g/m <sup>2</sup> .mm	>=900°C	Slight	Toxic	White Fibrous Glass
ABS	1.05±.g.	20g/10min(22°C/10kg)	None	Almost Odorless	Pellet

## Flammability Data

Components			
Lead	None	None	
Sulfuric Acid	None	None	
Hydrogen		4%-72.4%	Sealed batteries can emit hydrogen only if over charged(float volt.>2.4VPC)
Fiberglass Sep.	N/A	N/A	
ABS		1/16"HB	Toxic Vapors may be released.
(Acrylonitrile-styrene)	None	(UL-94,File no.E-6717m)	In case of fire:wear self-contained breathing apparatus. Storage conditions to avoid fire and heating above 60°C Dense smoke from heated material may cause respiratory irritation. In case of inhaling dense smoke, immediately remove a person to fresh air. If necessary,apply artificial respiration and seek medical attention immediately.

## First Aid (Sulfuric Acid Precautions)

Skin contact	Flush with water, see physician if contact area is large or if blisters form
Eye Contact	Call physician immediately and flush with water until physical arrives
Ingestion	Call physician.If patient in conclosum,flush mouth with water, have patient drink milk or sodium bicarbonate solution

## Reactivity Data

Component	Sulfuric Acid
Stability	Stable at all temperature
Polymerization	Will not polymerize
Incompatibility	Reactive metals,strong bases,most organic compounds
Decomposition Products	Sulfuric dioxide,trioxide,hydrogen sulfide,hydrogen
Conditions to Avoid	Prohibit smoking,sparks,eparks,etc.from battery charging area.Avoid mixing acid with other chemicals

## Spill or Leak Procedures

Steps to take in case of leak or spill	If sulfuric acid is spilled from a battery, neutralize acid with bicarbonate (baking soda),or calcium oxide (lime).Flush area with water and discard to the sewage system.Do not allow unneutralized acid into sewage system.
Waste Disposal Method	Neutralized acid may be flushed down the sewer.Spent batteries must be treated as hazardous waste and disposed of according to local,state, and federal guidelines.A copy of this MSDS must be supplied to any scrap dealer or secondary lead smelter with battery.

## Protection

Exposure Site	Protection	Comments
Skin	Rubber gloves,Apron	Protective equipment must be worn if the battery is cracked or otherwise damaged.A respirator should be worn during reclaim operations if the TLV exceeede.
Respiratory	Respirator(for lead)	
Eyes	Safety goggles,Face,Shiele	

## Electrical Safety

Due to the battery's low internal resistance and high power density, high levels of short circuit current can be developed across the battery terminals. Do not rest tools or cables on the battery. Use insulated tools only. Follow all installation instructions and diagrams when installing or maintaining battery systems.

## Health Hazard Data

Lead	The toxic effects of lead are accumulative and slow to appear.It affects the kidneys,Reproductive,and central nervous systems. The symptoms of lead overexposure are anemia,vomiting,headache, stomach pain(lead colic),dizziness,loss of appetite,and muscle and joint pain .Exposure to lead from a battery most often occurs during lead reclaim operations through the breathing or ingestion of lead dust fumes.
Sulfuric Acid	Sulfuric acid is strong corrosive. Contact with acid can cause severe burns on the skin and in eyes. Ingestion of sulfuric acid will cause GI tract burns.Acid can be released if the battery case is damaged or if vents are tampered with.
Fiberglass Separator	Fibrous glass is an irritant of the upper respiratory tract,skin and eyes.For exposure up to 10F/cc use MSA comfoll type type H filter. Above 10F/ CC up to 50F/CC use Ultra-Twin type H filter. This product is not considered. Carcinogenic by NTPor OSHA.