



USER MANUAL

Queen Star Series Online UPS 6K-20KVA

Contents

1. Brief introduction.....	1-6
1.1 System and model description.....	1
1.2 Description of commonly used symbols.....	2
1.3 Appearance.....	2-5
1.4 Product specification and performance.....	5-6
2. Safety Instruction.....	7
3. Installation.....	8-14
3.1 Unpacking and inspection.....	8
3.2 Input and output power wiring and protective earth ground installation.....	8-10
3.3 Operating procedure for connecting the long backup time model UPS with the external battery.....	10-11
3.4 Parallel operation.....	11-14
4. Operation and Operating mode.....	15-22
4.1 Operation.....	15-16
4.2 Operating mode.....	16-22
5. Battery maintenance.....	23
6. Notes for battery disposal and battery replacement.....	24
7. Troubleshooting.....	25-26
Appendix 1 Description of Display panel.....	27-28
Appendix2 Indicator and alarm.....	29-30
8. Chapter Operation (LCD model)	31-42
8.1 Operation Display Panel.....	31
8.2 Operation Mode.....	32-36
8.3 Operating Instructions.....	36-38
8.4 Checking UPS function.....	38
8.5 Setting the output voltage and frequency.....	38-39
8.6 Troubleshooting.....	39-42

1. Brief introduction

1.1 System and model description

The On-Line-Series is an uninterruptible power supply incorporating double-converter technology. It provides perfect protection specifically for strict load. The double-converter principle eliminates all mains power disturbances. A rectifier converts the alternating current from the socket outlet to direct current. This direct current charges the batteries and powers the inverter. In the event of power failure, the maintenance-free batteries power the inverter. Thus the inverter generates a sine wave AC power, which permanently supplies the loads.

Designed with the proven on-line, double conversion architecture, this series of UPS offers the greatest degree of availability in power protection and provides continuous high-quality AC power to connect strict load, especially for the basic equipments in some areas as: finance, communication, government, traffic, manufacture, education and so on.















This manual is applicable to the following models:

Type		Model	Input	Battery
Standard	6KVA	6K	Single phase + N	Inbuilt
	10KVA	10K	Single phase + N	Inbuilt
Long back up time	6KVAL	6KL	Single phase + N	External battery bank
	10KVAL	10KL	Single phase + N	External battery bank
	10KVAL	31 10KL	Three-phase + N + PE	External battery bank
	12KVAL	31 12KL	Three-phase + N + PE	External battery bank
	15KVAL	31 15KL	Three-phase + N + PE	External battery bank
	20KVAL	31 20KL	Three-phase + N + PE	External battery bank

1. Brief introduction

1.2 Description of commonly used symbols

The following symbols will be used in this manual and may appear during the course of your practical applications. Therefore, all users should be familiar with them and understand their meanings.

Notation and Explanation			
Notation	Explanation	Notation	Explanation
	Alert you to pay special attention		Protective ground
	Caution of high voltage		Alarm silence
	Turn on the UPS		Overload indication
	Turn off the UPS		Battery check
	Idle or shut down the UPS		Recyclable
	Alternating current source (AC)		Do not dispose with ordinary trash
	Direct current source (DC)		Battery

1.3 Appearance

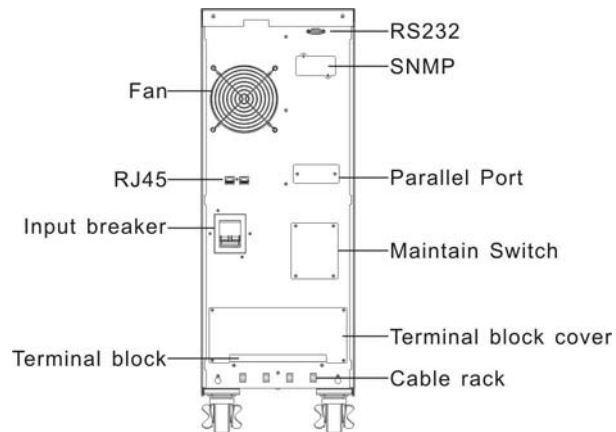

BACK VIEW OF 6K

1. Brief introduction

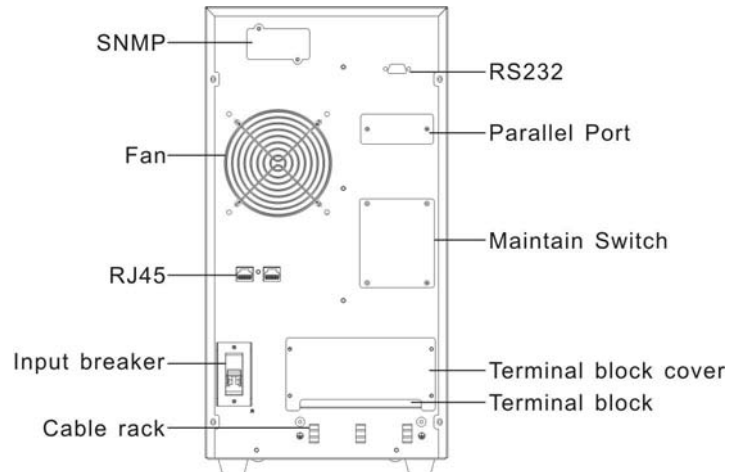

BACK VIEW OF 6KL

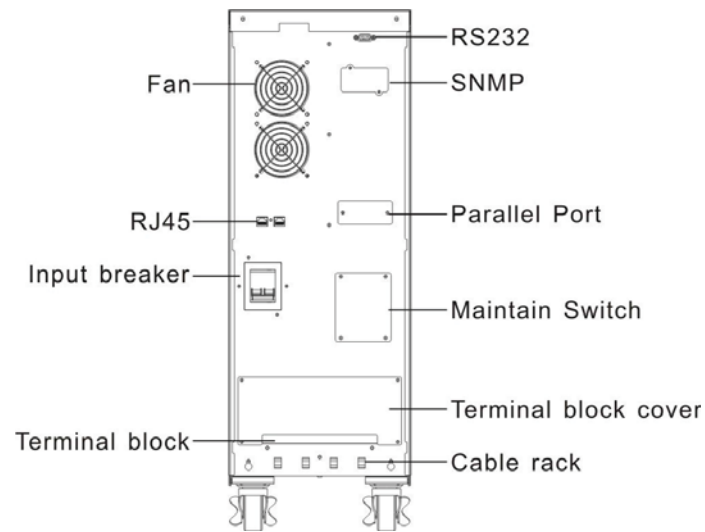

BACK VIEW OF 10K

1. Brief introduction

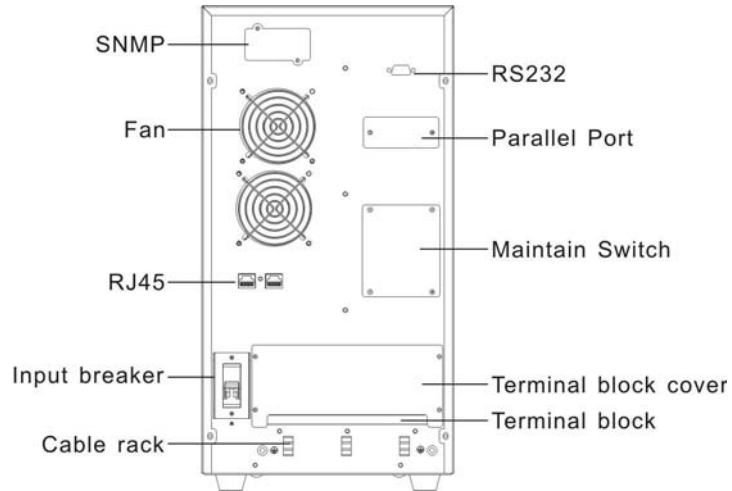

BACK VIEW OF 10KL

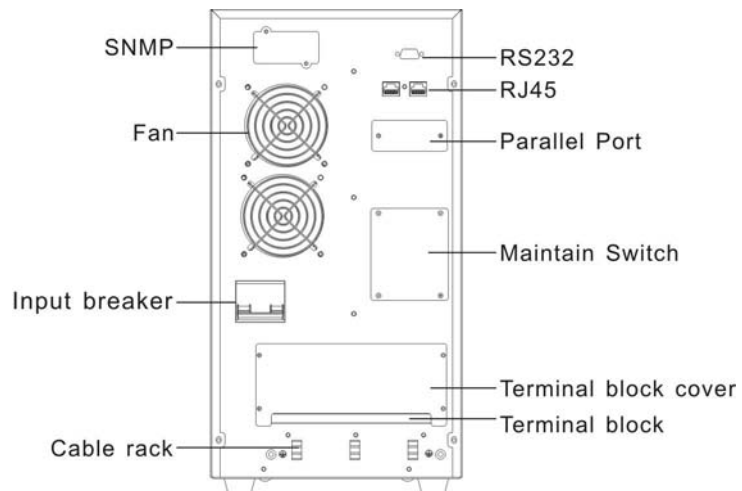

BACK VIEW OF 31 10KL

1. Brief introduction

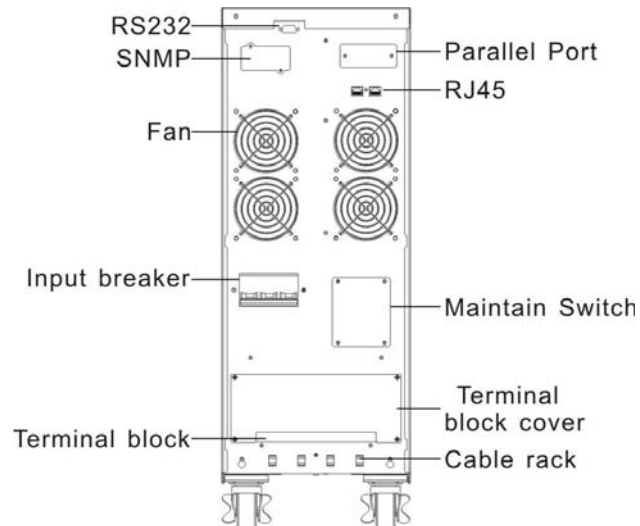

BACK VIEW OF 31 12KL/31 15KL/31 20KL

1.4 Product specification and performance

•General specification

Power Rating	Model	Frequency (Hz)	Input		Output		Dimensions (L*W*H)mm	Weight (kg)
			Voltage (VAC)	Current	Voltage	Current		
6KVA/4.8KW	6K	50	(120-274)	32Amax	220VAC	27A	560x260x717	61.5
6KVA/4.8KW	6KL	50	(120-274)	32Amax	220VAC	27A	533x260x501	21
10KVA/8KW	10K	50	(120-274)	50Amax	220VAC	45A	560x260x717	67.5
10KVA/8KW	10KL	50	(120-274)	50Amax	220VAC	45A	533x260x501	23
10KVA/8KW	31 10KL	50	(120-274)	50Amax	220VAC	45A	533x260x501	24
12KVA/9.6KW	31 12KL	50	(120-274)	80Amax	220VAC	54A	560x260x717	39.5
15KVA/12KW	31 15KL	50	(120-274)	80Amax	220VAC	68A	560x260x717	39.5
20KVA/16KW	31 20KL	50	(120-274)	100Amax	220VAC	91A	560x260x717	39.5

Note: Output voltage can be set: 200V/208V/220V/230V/240V.

Frequency can be set as 60Hz.

1. Brief introduction

●Electrical performance

Input			
Model	Voltage	Frequency	Power Factor
6K(L)/10K(L)	Single-phase(220VAC/230VAC)	50/60Hz	>0.99(Full load)
31 10KL/31 12KL/ 31 15KL/31 20KL	Three-phase (380VAC/220VAC、 380VAC/230VAC)	50/60Hz	>0.95(Full load)

Output					
Voltage regulation	Power factor	Frequency	Distortion	Overload capacity	Current crest ratio
±1%	0.8 lag	Line mode: (1)、Synchronized 46 ~ 54Hz; (2)、50Hz (Line 40~ 46 and 54~ 60Hz) Battery mode: 50Hz	THD<2% Full load (Linear load)	105%-125%load transfers to bypass mode after 1 minutes; 125-135% load transfers to bypass mode after 30second	3:1 maximum

●Operating environment

Temperature	Humidity	Altitude	Storage temperature
0°C-40°C	<95%	<1000m	0°C-40°C

Note: If the UPS is installed or used in a place where the altitude is above than 1000m, the output power must be decrease in use, please refer to the following:

Altitude(M)	1000	1500	2000	2500	3000	3500	4000	4500	5000
Load	100%	95%	91%	86%	82%	78%	74%	70%	67%

2. Safety Instruction

- Even if the interruptible Power System (UPS) is not connected to utility power, the output socket of the UPS may still present 220V/230V output voltage.
- If it is necessary to replace the external battery cord or power cord, please purchase the original material from the service center or distributor of our company so as to avoid overheating or sparks resulting in fire due to insufficient capacity.
- Do not let battery or batteries get close to any heating source and do not incinerate battery or batteries, they may explode.
- Do not open or mutilate the battery or batteries, released electrolyte is highly poisonous and harmful to the skin and eyes.
- Do not short the positive and negative of battery electrode. Otherwise, it may cause electric shock or fire.
- To avoid the risk of being shocked, please do not attempt to open the case of the UPS.
- A battery can present a risk of electric shock and high short circuit current.
- Do not plug household appliances such as hair dryers to UPS.

3. Installation

3.1 Unpacking and inspection

- 1) Unpack the packaging and check the package contents. The shipping package contains:
 - A UPS
 - A user manual
 - A communication cable
- 2) Inspect the appearance of the UPS to see if there is any damage during transportation. Do not turn on the unit and notify the carrier and dealer immediately if there is any damage or lacking of some parts.

3.2 Input and output power wiring and protective earth ground installation

3.2.1 Notes for installation

- 1) The UPS must be installed in a location with good ventilation, far away from water, inflammable gas and corrosive agents.
- 2) The UPS should not be tilted. The air inlet port at the lower part of the front panel and the fan outlet port on the rear panel should not be blocked so as to ensure good ventilation (Allow at least 0.5m of space on each side).
- 3) In case if the UPS is unpacked, installed and used at very low temperatures, condensation of water drops may appear. It is necessary to wait until the UPS is fully dried inside out before proceeding to installation and use. Otherwise, there may be a risk of electric shock.

3.2.2 Installation

Installation and wiring must be performed in accordance with the local electric code and the following instructions by professional personnel. For safety, please cut off the mains power breaker before installation. The battery breaker also needs to be cut off if it is a long backup time model.

- 1) Open the terminal block cover located on the rear panel of the UPS (please refer to the appearance diagram).
- 2) For 6K(L) UPS, it is recommended to select the UL1015 10AWG (6mm²) wire or other insulated wire which complies with AWG Standard for the UPS input and output wirings.

3. Installation

- 3) For 10K(L)/31 10KL UPS, it is recommended to select the UL1015 8AWG (10 mm²) wire or other insulated wire which complies with AWG Standard for the UPS input and output wirings.
- 4) For 31 12KL/31 15KL/31 20KL UPS, it is recommended to select the UL1015 6AWG (25mm²) wire or other insulated wire which complies with AWG Standard for the UPS input and output wirings.

Note: Do not use the wall receptacle as the input power source for the UPS, as its rated current is less than the UPS's maximum input current. Otherwise the receptacle may be burned and destroyed. (Please refer to section 1.4)

- 5) Connect the input and output wires to the corresponding input and output terminals according to the following diagram.

Note: You must make sure that the input and output wires and the input and output terminals are connected tightly.

- 6) The protective earth ground wire refers to the wire connection between the equipment which consumes electro-equipment and the ground wire. The wire diameter of protective earth ground wire should be at least as above mentioned for each model and green wire or green wire with yellow ribbon wire is used.
- 7) After having completed the installation, make sure the wiring is correct.
- 8) Please install the leak current protective breaker at the output power distribution panel of the UPS if necessary.
- 9) To connect the load with the UPS, please turn off all the loads first, then perform the connection and finally turn on the loads one by one.
- 10) No matter the UPS is connected to the utility power or not, the output of the UPS may have electricity. The parts inside the unit may still have hazardous voltage after turning off the UPS. To make the UPS have no output, power off the UPS, and then disconnect the utility power supply.
- 11) Suggest charging the batteries for 8 hours before use. After connection, turn the input breaker in the "ON" position, the UPS will charge the batteries automatically. You can also use the UPS immediately without charging the batteries first, but the backup time may be less than the standard value.

3. Installation

- 12) If it is necessary to connect the inductance load such as a monitor or a laser printer to the UPS, the start-up power should be used for calculating the capacity of the UPS, as its start-up power consumption is too big when it is started.

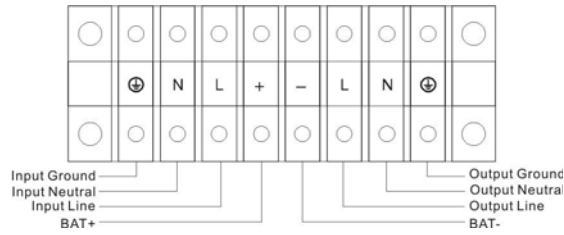

Input and Output Terminal Block wiring diagram of 6K(L)/10K(L)

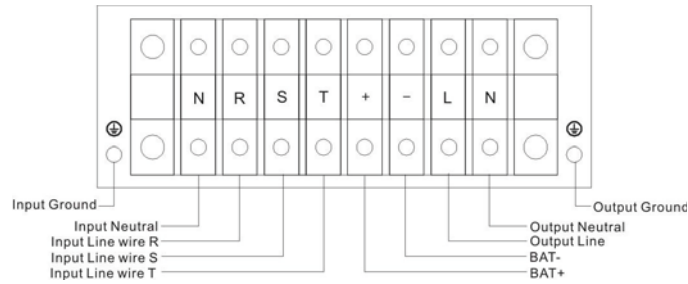

Input and Output Terminal Block wiring diagram of
31 10KL/31 12KL/31 15KL/31 20KL

3.3 Operating procedure for connecting the long backup time model UPS with the external battery

3.3.1 The nominal DC voltage of external battery pack is 192VDC. Each battery pack consists of 16 pieces of 12V “maintenance-free” batteries in series. To achieve longer backup time, it is possible to connect multi-battery packs, but the principle of “same voltage, same type” should be strictly followed.

3.3.2 For 6KL/10KL/31 10KL/31 12KL/31 15KL/31 20KL, the procedure of installing battery bank should be complied with strictly. Otherwise you may encounter the hazardous of electric shock.

3. Installation

- 1) A DC breaker must be connected between the battery pack and the UPS. The capacity of breaker must be not less than the data specified in the general specification as follow.

Model	6K	6KL	10K	10KL	31 10KL	31 12KL	31 15KL	31 20KL
Battery voltage	192VDC	192VDC	192VDC	192VDC	192VDC	192VDC	192VDC	192VDC
Battery current	34A max.	34A max.	56A max.	56A max.	56A max.	62A max.	78A max.	104A max.

Note: 240VDC battery voltage can be choose for 6K(L)/10K(L).

- 2) Set the battery pack breaker in “OFF” position and connect the 16 pieces of batteries in series.

3.3.3 To complete the connection by plugging the connector of the external battery cable into the external battery socket of the UPS. Do not attempt to connect any loads to the UPS now. You should connect the input power wire to the right position first. And then set the breaker of the battery pack in the “ON” position. After that set the input breaker in the “ON” position. The UPS begins to charge the battery packs at the time.

3.4 Parallel operation

3.4.1 Brief introduction of the redundancy

N+X is currently the most reliable power supply structure. N represents the minimum UPS number that the total load needs; X represents the redundant UPS number, i.e. the fault UPS number that the system can handle simultaneously. The bigger the X is, the higher reliability of the power system is. For occasions where reliability is highly required, N+X is the optimal mode. As long as the UPS is equipped with parallel cables, up to 3 of them can be connected in parallel to realize output power sharing and power redundancy.

3.4.2 Parallel installation

- 1) Users need to opt a standard 25-pin communication cable, which should have 25 cores, corresponding stitches and shield, as the UPS parallel cable. The length of the parallel cable is appropriate to be less than 3 m.
- 2) Strictly follow the stand-alone wiring requirement to perform the input wiring of each UPS.

3. Installation

- 3) Connect the output wires of each UPS to an output breaker panel first, and then connect the wiring to the load via the breaker panel.
- 4) The parallel UPS must be equipped with battery individually.
- 5) Please refer the figure followed to see the wiring of parallel operation. The capacity of the breaker must be not less than the specification as follow.

Model No.	Capacity of breaker
6K(L)	≥40A/250VAC
10K(L)/31 10KL	≥60A/250VAC
31 12KL /31 15KL/31 20KL	≥100A/250VAC

*The requirement of the output wiring is as follows:

- When the distance between the UPSs in parallel and the breaker panel is less than 20 meters, the difference between the wires of input & output of the UPSs is required to be less than 20%;
- When the distance between the UPSs in parallel and the breaker panel is greater than 20 meters, the difference between the wires of input & output of the UPSs is required to be less than 10%.

3.4.3 Operation and maintenance

- 1) To perform the general operation, follow the stand-alone operating requirement.
- 2) Start up: The units transfer to INV mode simultaneously as they start up sequentially in utility power mode.
Shutdown: the units shut down sequentially in INV mode. When the last one completes the shutdown action, each unit will shut down the inverter simultaneously and transfer to bypass mode.

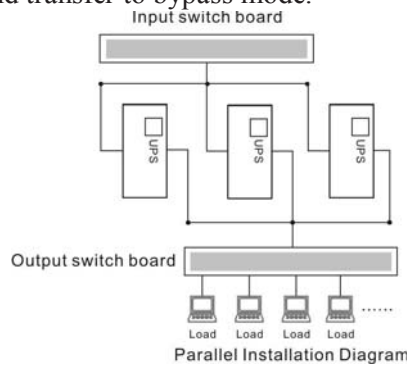

- 3) To perform the maintenance, follow the stand-alone requirement.

3. Installation

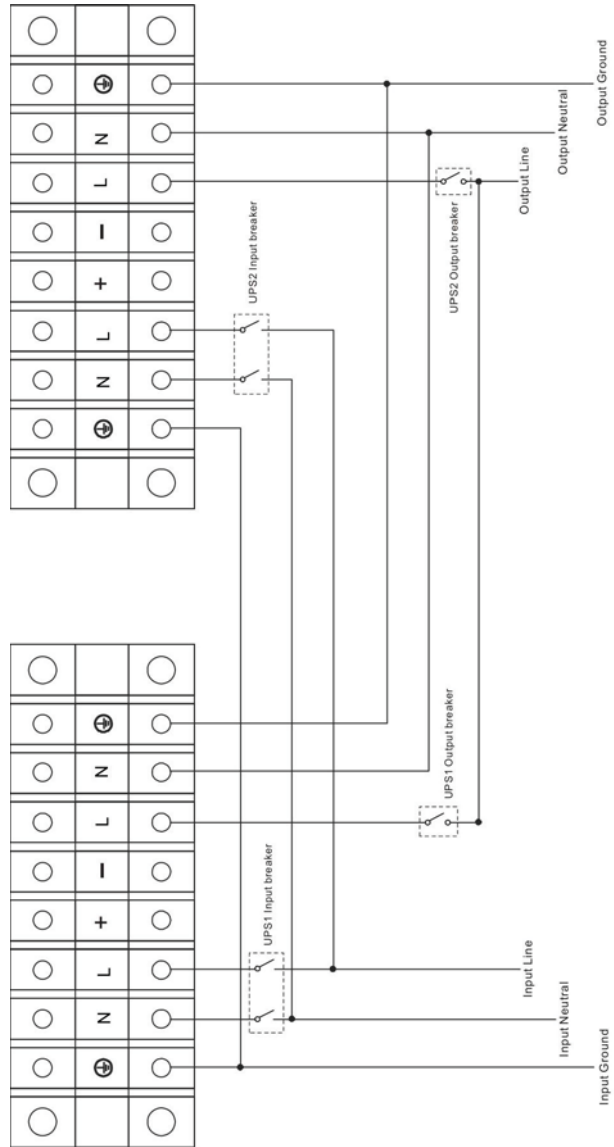

Parallel installation wiring diagram of 6K/10K

3. Installation

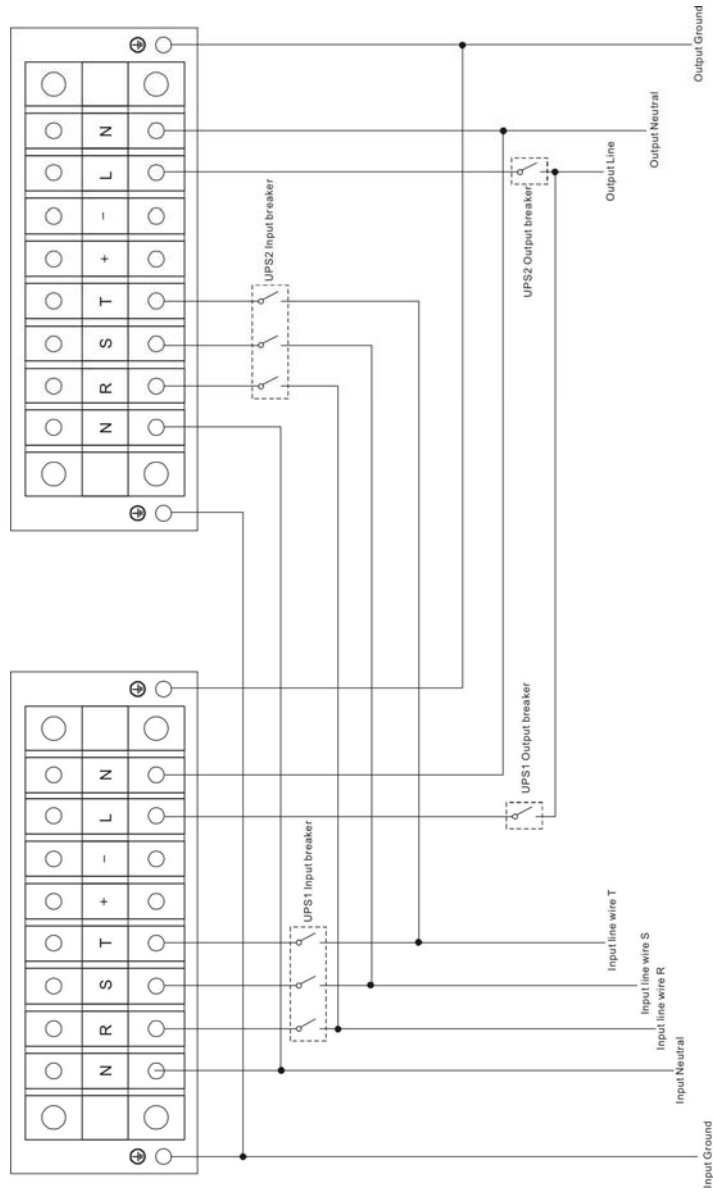

31 Parallel Installation Wiring Diagram

4. Operation and Operating mode

It is easy to operate the equipment, with no previous training. You just need to read through this manual and operate according to the instructions in it. The meaning of the LED indicators, please refer to the appendix 1 “Display panel”.

4.1 Operation

4.1.1 Turn on the UPS with utility power supplied

- 1) After you make sure that the power supply connection is correct, set the input breaker in the “ON” position first. At this time the fan rotates and the UPS supplies power to the load via the bypass. The UPS operates in Bypass mode.
- 2) To power on the UPS by simply pressing the “ON” button continuously for more than 1 second.
- 3) When being powered on, the UPS will perform self-diagnosis, with the load/battery level LEDs turned on and then off one after another in ascending order. A few seconds later, the INV LED is turned on, the UPS is already running in Utility Power mode. If the utility power is abnormal, the UPS will operate in battery mode without output interruption of the UPS.

4.1.2 Turn on the UPS with no utility power supplied

- 1) Press the “ON” button continuously for more than 1 second to power on the UPS. For long back up time model (“L” model), please make sure that the battery breaker is in “ON” position.
- 2) During the course of starting up, the UPS has the same action as if it is connected to utility power except that the utility power LED is not turned on and the battery LED is turned on instead.

4.1.3 Turn off the UPS with utility power supplied

- 1) Press the “OFF” button continuously for more than 1 second to turn off the inverter of the UPS immediately.
- 2) When being powered off, the UPS will perform self-diagnosis, the Load/Battery level LEDs will be turned on and then off one after another in ascending order, then the INV LED will be turned off and Bypass

4. Operation and Operating mode

LED will be turned on. The UPS is working in Bypass mode.

- 3) Upon completion of the above to turn it off, output of electric current of the UPS is still present. In order to cut off the output from the UPS, simply cut off the utility power supply and the UPS will perform self-diagnosis, finally not any display is shown on the display panel and no voltage output is available from the UPS output.

4.1.4 Turn off the UPS with no utility power supplied

- 1) Press the “OFF” button continuously for more than 1 second to power off the UPS.
- 2) When being powered off, the UPS will perform self-diagnosis, the Load/Battery level LEDs will be turned on and then off one after another in ascending order. Finally not any display is shown on the display panel and no voltage is available from the UPS output.

Suggestions:

Please turn off the connected loads before turning on the UPS and turn on the loads one by one after the UPS is working in INV mode. Turn off all of the connected loads before turning off the UPS.

4.2 Operating mode

4.2.1 Normal power mode

In the normal mode, the display on the front panel is shown in the following diagram. The utility power indicator and the Inverter indicator are turn on.

The load/battery capacity indicator will be turned on in accordance with the load capacity connected.

1. If the utility power indicator blinks, it indicates that there are problems with reversed polarity (L, N) of site wiring or disconnect with ground that may result in shock hazard. UPS is still working in normal mode. If the battery indicator is turn on at the same time, it shows that the voltage or frequency of the utility power is out of the normal input range of the UPS. The UPS works in battery mode.

4. Operation and Operating mode

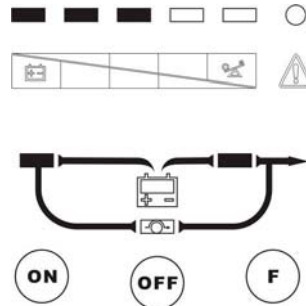

Figure 4-1 Normal Mode

2. If output overloaded, the load level indicators will be turned on and alarm will beep every second. You should get rid of some unnecessary loads one by one to decrease the loads connected to the UPS less than 95% capacity of the UPS.
3. If the battery indicator blinks, it indicates that no battery is connected to the UPS or battery voltage is too low. You should check if battery is properly connected to the UPS, and press function button more than 5 seconds to start the battery self-diagnosis. If the connection between battery and UPS is confirmed without any problem, it may be due to the defect or aging of the battery, please refer to the “troubleshooting” in chapter 7 to solve the problem accordingly.

Note: Connection to the power generator should be made according to the following steps:

- Activate the power generator and wait until the operation is stable before connecting the output of the power generator to the UPS (be sure that the UPS is in idle mode). Then, turn on the UPS according to the startup procedure. After the UPS is turned on, the loads are connected one by one.
- It is recommended that the capacity of the AC generator chosen should double that of the UPS.

4.2.2 Battery mode

In battery mode the display on the front panel is shown in the following diagram. The battery indicator and the inverter indicator are turned on. If the

4. Operation and Operating mode

utility power indicator blinks at the same time, it shows that the utility power is abnormal. The load/battery capacity indicators will be turn on in accordance with the battery capacity. Please note that the load/battery capacity indicator in normal mode will indicate the battery capacity in battery mode.

1. When the UPS is running in battery mode, the alarm will beep every 4 seconds. If the “Function” key is pressed for more than 5 seconds, the alarm will not beep (silence function). Press the “Function” key more than 5 seconds again to resume the alarm function.

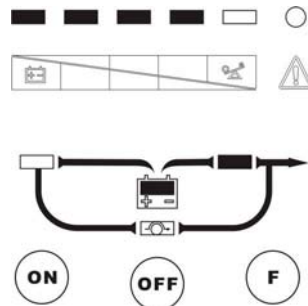

Figure 4-2 Battery Mode

2. When the battery capacity decreases, the number of load/battery capacity indicators turned on will decrease. If the battery voltage drops to the pre-alarm level (capable of maintaining the backup time for more than 2 minutes), the alarm will beep every second to remind the user of insufficient battery capacity.

4.2.3 Bypass mode

When operating in bypass mode set up through UPSilon software, the display on the front panel is show in the following diagram. The utility power indicator and the bypass indicator are turn on. The load/battery capacity indicator will be turned on in accordance with the load capacity connected.

1. If the utility power indicator blinks, it shows that the voltage or frequency of the utility power is out of the input range of the UPS or there are problems with reversed polarity (L/N) of site wiring or

4. Operation and Operating mode

disconnect to the ground for protection.

- When operating in bypass mode, the UPS beeps every 2 minutes, If the “Function” key is pressed for more than 5 seconds, the alarm will not beep (silence function). Press the “Function” key more than 5 seconds again to resume the alarm function.

Notes: When operating in bypass mode, the backup function of the UPS is not available and the power used by the load is directly from the utility power via internal EMI filter.

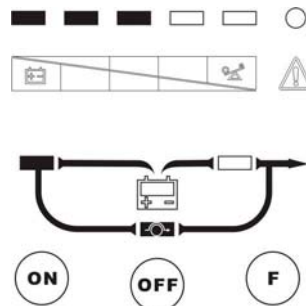

Figure 4-3 Bypass Mode

4.2.4 Abnormality mode

In case the fault LED is turned on when the UPS is in use, it shows that the UPS is operating in abnormal mode. Please refer to the troubleshooting in section 7 for details.

4.2.5 Setting the output voltage and frequency

- Connect the mains input to the UPS, and make the UPS works in standby mode or bypass mode.
- Press the ‘F’ and ‘OFF’ button more than one second, then release, the buzzer will beep once, and the bypass indicator with battery indicators will flash once every second, which means all of bottom are used for UPS setting. At this point, if the voltage setting is enabled (the Inverter indicator is lit), the No of lighted load led indicator represents current setting value of output voltage, and if the frequency setting is enabled (inverter lights flash), the No of lighted load led indicator represents

4. Operation and Operating mode

current output frequency setting value.

- 3) If you need to set the voltage, check the voltage setting is enabled (the inverter indicator is lit), if not, press the 'F' more than one second, then release, the inverter indicator will be turn on, at this point you can start to set output voltage.
- 4) Release the 'OFF' key after you press it more than one second, the next load led indicator will be turn on.
- 5) Repeat the fourth step until the No of lighted load indicator meets the required voltage.
- 6) Press 'ON' key about one second, the output voltage setting completed.
- 7) The frequency setting is the same as the voltage setting, but before the setting, please confirm the frequency setting is enabled (the inverter indicator blink), if not, press 'ON' key about one second in order to switch to the frequency setting screen.
- 8) When done, Press the 'F' and 'OFF' button more than one second, then release, the buzzer will beep once, exit the setting mode.

In the setting process, if no key is detected within twenty second, the UPS exits the setting screen automatically.

The relation of the No of lighted load led and voltage/ frequency as follows.

Current setting	L1	L2	L3	L4	L5	L6
value of output						
voltage and	220V	230V	240V	208V	200V	
frequency	50Hz	60Hz	Automatically detect the frequency			

Note: L1 ~ L4 are the green lights, L5 is the yellow light, L6 is the red light.

4.2.6 Backup time for the standard model

The backup time of the long backup time model is dependent on the external battery pack capacity and the load level as well as other factors.

The backup time of standard model may vary from different models and load level.

4. Operation and Operating mode

Please refer to the following:

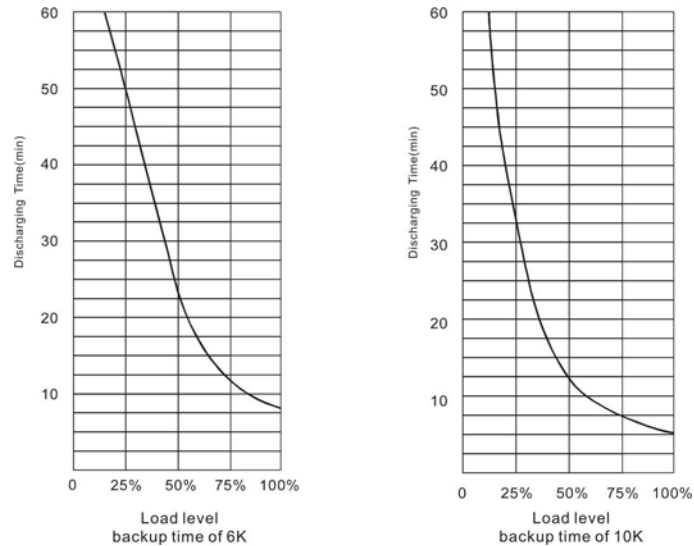

4.2.7 Internet Communication

This series is equipped with an intelligent slot for Web power (optional accessory) or other optional card to achieve remote management of the UPS. Please contact your local distributor for further information.

4.2.8 Description of communication interface

1) The standard RS232 port is applicable to communicate with computer.

Description and pin assignment of RS232

Baud rate: 2400bps

Data bit: 8 bit

Ending bit: 1bit

Parity bit: None

DB-9 pin assignment:

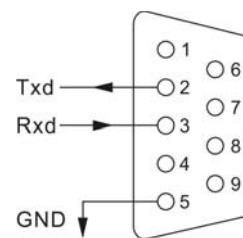

RS232 Interface

4. Operation and Operating mode

Pin number	Function description	I/O
3	Rxd	Input
2	Txd	Output
5	GND	Ground

2) User enables to monitor and manage the UPS through installed the AS400 card (optional).

PIN1: UPS failure (normally open, active close)

PIN2: Summary alarm

PIN3: Ground

PIN4: Remote shutdown

PIN5: Common

PIN6: Bypass active (relay close)

PIN7: Low battery

PIN8: UPS on (relay close)

PIN9: Utility Power failure (normally open, active close)

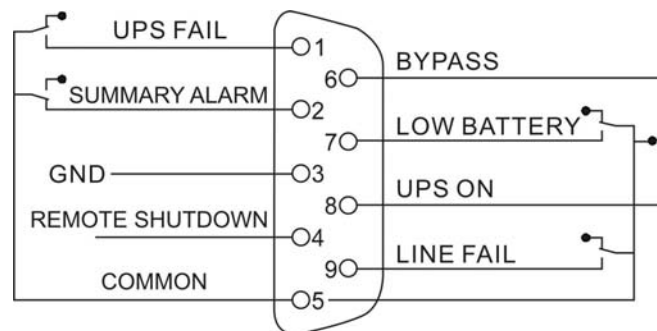

AS400 Interface

5. Battery maintenance

- This series UPS only requires minimal maintenance. The battery used for standard models is valve regulated sealed lead-acid maintenance free battery. These models require minimal repairs. The only requirement is to charge the UPS regularly in order to maximize the expected life of the battery. When being connected to the utility power, whether the UPS is turned on or not, the UPS keeps charging the batteries and also offers the protective function of overcharging and over discharging.
- The UPS should be charged once every 4 to 6 months if it has not been used for a long time. In the regions of hot climates, the battery should be charged and discharged every 2 months. The standard charging time should be at least 12 hours.
- Under normal conditions, the battery life lasts 3 to 5 years. In case if the battery is found not in good condition, earlier replacement should be made. Battery replace event should be performed by qualified personnel.
- Replace batteries with the same number and same type of batteries.
- Keep the ambient temperature between 15°C and 25°C.
- Do not replace the battery individually. All the batteries should be replaced at the same time following the instructions of the battery supplier.
- Normally, the batteries should be charged and discharged once every 4 to 6 months. Charging should begin after the UPS shuts down automatically in the course of discharging, the standard charging time for the standard UPS should be at least 12 hours. Discharge the battery with the load more than 50%.

6. Notes for battery disposal and battery replacement

- 1) Before disposing batteries, remove conductive articles such as necklace, wrist watches and rings.
- 2) If it is necessary to replace any connection cables, please purchase the original materials from the authorized distributors or service centers, so as to avoid overheating or spark resulting in fire due to insufficient capacity.
- 3) Do not dispose of batteries or battery packs in a fire, they may explode.
- 4) Do not open or mutilate batteries, released electrolyte is highly poisonous and harmful to the skin and eyes.
- 5) Do not short the positive and negative electrodes of the battery, otherwise, it may result in electric shock or fire.
- 6) Make sure that there is no voltage before touching the batteries. The battery circuit is not isolated from the input potential circuit. There may be hazardous voltage between the battery terminals and the ground.
- 7) Even though the input breaker is disconnected, the components inside the UPS are still connected with the batteries, and there are potential hazardous voltages. Therefore, before any maintenance and repairs work is carried out, switch off the breaker of the battery pack or disconnect the jumper wire of connecting between the batteries.
- 8) Batteries contain hazardous voltage and current. Battery maintenance such as the battery replacement must be carried out by qualified personnel who are knowledgeable about batteries. No other persons should handle the batteries.

7. Troubleshooting

Problem	Possible cause	Solution
The 1# Fault LED and the 6# LED are turned on, the buzzer beeps continuously	The UPS shutdown due to internal overheat	Make sure the UPS is not overloaded; the air vents are not blocked and the ambient temperature is not too high. Wait for 10 minutes for the UPS to cool down before turning on again. If failed, please contact the distributor or service center.
The 1# Fault LED and the 2# and 5# LED are turned on, and the buzzer beeps continuously	The UPS output is short circuited.	Turn off the UPS. Remove all the loads. Ensure that the load is not failed or the UPS has no internal faults before turning it on again. If failed, please contact the distributor or service center.
The 1# Fault LED and the 4# LED are turned on, the UPS beeps continuously	The UPS shuts down due to its internal fault.	Please contact the distributor or service center.
The 1# Fault LED and the 5# LED are turned on, the UPS beeps continuously	The UPS shuts down due to its internal fault.	Please contact the distributor or service center.
The utility power LED flashes	The voltage or frequency of the utility power is out of the input range of the UPS.	The UPS is running in battery mode. To save your data and close the application program. Make sure the utility power is within the input voltage or frequency range permitted by the UPS.
The 1# Fault LED and the 2# LED are turned on, the UPS beeps continuously	The UPS is overloaded or the load equipment is faulty	Check the loads and remove all no critical equipment. Recalculate the load power and reduce the number of loads connected to the UPS. Check that the loads are not failed.
The 1# Fault LED and the battery LED are turned on, the buzzer beeps every second	The charger of the UPS is defective.	Please contact the distributor or service center.

7. Troubleshooting

Problem	Possible cause	Solution
Battery LED flashes	Low battery	Check the battery. If the battery is damaged, replace the battery immediately and ensure that the battery breaker is in "ON" position.
The utility power is normal, but the UPS can not turn in line mode	AC input breaker in "OFF" position	Set the input breaker in "ON" position.
Battery discharging time diminishes	Battery not yet been fully charged	Keep UPS connected to utility power persistently for more than 10 hours to recharge the batteries again.
	UPS overloaded	Check the loads and remove the non-critical equipment.
	Battery aged	Replace the batteries. Please contact the distributor to obtain the parts and replacement service.
The UPS cannot power on after pressing the "ON" button	The "ON" button is pressed too briefly	Press the "ON" button for more than 1 second.
	The UPS is not connected to the battery or the battery pack voltage is too low.	Check the battery or recharge the battery.
	UPS internal fault	Please connect the distributor or service center.

When you contact the service center, please provide the following information:

- Model No. and the serial No. of the UPS;
- The date when the problem arose;
- Complete description of the problem, including the LED display, alarm warning, power condition and load capacity. If your UPS is a long backup time model, you may also provide the battery information.

Appendix 1 Description of Display panel

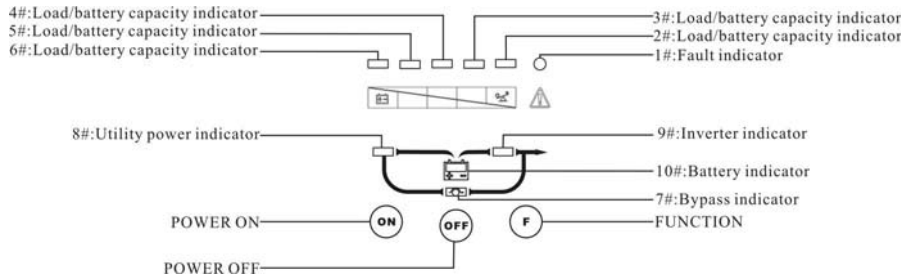

1. ON button:
Pressing the ON/OFF button more than 1 second, the UPS system is turned on.
2. OFF button:
By pressing this button more than 1 second turns off the UPS system whenever the UPS run under the normal mode/battery mode.
3. Function button
The Function button provides the following functions:
 - 1) Battery self- diagnosis: When the UPS ran in normal mode, pressing this button more than 5 seconds (buzzer beeps twice) can start the battery self-diagnosis.
 - 2) Silence function in battery/bypass mode
In battery/bypass mode, when the buzzer beeps, pressing and holding the function button for more than 5 seconds (buzzer beeps one times) can silence the buzzer. Press the button for more than 5 seconds (buzzer beeps twice) again to resume the alarm function.

Note: The alarm silencing function of the Function button is valid only in battery mode, and invalid for any other UPS alarm.
4. LED indicators
The LEDs contains Fault indicator, Load/battery capacity indicator, Bypass indicator, utility power indicator, Inverter indicator, Battery indicator.

Appendix 1 Description of Display panel

Table Appendix 1 Description of indicators

No.	Color	Indicator	Description
1#	Red	Fault indicator	When the indicator on, it shows that the UPS in abnormal condition.
2#	Orange	Load/battery capacity indicator	Show the capacity of load/battery: 1. Indicate the percentage of the load capacity in normal mode and bypass mode. 2. Indicate the battery capacity level in battery mode.
3#	Green	Load/battery capacity indicator	
4#	Green	Load/battery capacity indicator	
5#	Green	Load/battery capacity indicator	
6#	Green	Load/battery capacity indicator	
7#	Orange	Bypass indicator	When the indicator on, it shows that the loading current is supplied from the utility power directly.
8#	Green	Utility power indicator	When the indicator on, it shows that the utility power is normal.
9#	Green	Inverter indicator	When the indicator on, it shows that the load current is supplied from utility power or battery via the inverter.
10#	Orange	Battery indicator	When the indicator on, it shows that the load current is supplied from battery via the inverter.

Appendix2 Indicator and alarm

No.	Operating status		LED indicators										Audible alarm
			1 #	2 #	3 #	4 #	5 #	6 #	7 #	8 #	9 #	10 #	
1	Normal mode	0%--25% Load						●		●	●		None
2		26%--50% Load					●	●		●	●		None
3		51%--75% Load				●	●	●		●	●		None
4		76%--100% Load			●	●	●	●		●	●		None
5		101%--105% Load		●	●	●	●	●		●	●		None
6	Battery mode	0~20% Battery capacity		●							●	●	Beep once every sec
7		21%~40% Battery capacity		●	●						●	●	Beep once every 4 sec.
8		41%~60% Battery capacity		●	●	●					●	●	Beep once every 4 sec.
9		61%~80% Battery capacity		●	●	●	●				●	●	Beep once every 4 sec.
10		81%~100% Battery capacity		●	●	●	●	●			●	●	Beep once every 4 sec.
11	Bypass mode			↑	↑	↑	↑	●	●	●			Beep once every 2 min.
12	Overloaded in Normal mode			●	●	●	●	●		●	●		Beep twice every sec
13	Overloaded in bypass mode			●	●	●	●	●	●	●			Beep twice every sec
14	Utility power abnormal			↑	↑	↑	↑	↑	↑	★	↑	↑	None
15	Bypass mode abnormal			↑	↑	↑	↑	↑	↑	★	↑	↑	None
16	Overload in Battery mode, pre-alarm			●	↑	↑	↑	↑		↑	●	●	Beep twice every sec
17	Overload fault		●	●						↑			Sustained beep
18	Overheating fault		●					●	↑	↑			Sustained beep
19	Inverter fault		●				●		↑	↑			Sustained beep
20	Output short circuit		●	●			●			↑			Sustained beep

Appendix2 Indicator and alarm

No.	Operating status	LED indicators										Audible alarm
		1 #	2 #	3 #	4 #	5 #	6 #	7 #	8 #	9 #	10 #	
21	BUS voltage fault	●			●			↑	↑			Sustained beep
22	Charger or battery fault	●						↑	↑		★	Beep once every sec
23	Fan failure	●	●				●	↑	↑	↑	↑	Beep once every sec
24	Parallel fault	●	●	●			●	↑	↑			Sustained beep
25	ID repetition	●	●		●			↑				Sustained beep
27	BAT voltage low	↑	↑	↑	↑	↑	↑	↑	↑	↑	★	Beep once every sec
28	Over Charger	●		●				↑	↑	↑	↑	Sustained beep
29	Reversed polarity (L, N) of input wiring or disconnected with ground.		↑	↑	↑	↑	●	↑	★	↑	↑	Beep once every sec
30	BAT fault	●		●	●			↑	↑			Sustained beep
31	EPO mode	↑	↑	↑	↑	↑	↑	★	★	★	★	Beep once every sec
32	Bus short	●			●	●		↑	↑			Sustained beep
33	Negative power fault	●	●	●	●			↑	↑			Sustained beep
34	React Power Fault	●		●	●		●	↑	↑			Sustained beep
35	Power Fault	●	●		●	●	●	↑				Sustained beep
36	Inv Rly Stick Fault	●			●		●	↑	↑			Sustained beep
37	Inv Rly Open Fault	●				●	●	↑	↑			Sustained beep
38	Line SCR Fault	●			●	●	●	↑	↑			Sustained beep
39	Line In Fuse Open Fault	●		●		●		↑	↑			Sustained beep

LED indicator description: ●: On ★: Flash ↑: Depending on other conditions

8. Chapter Operation (LCD model)

8.1 Operation Display Panel

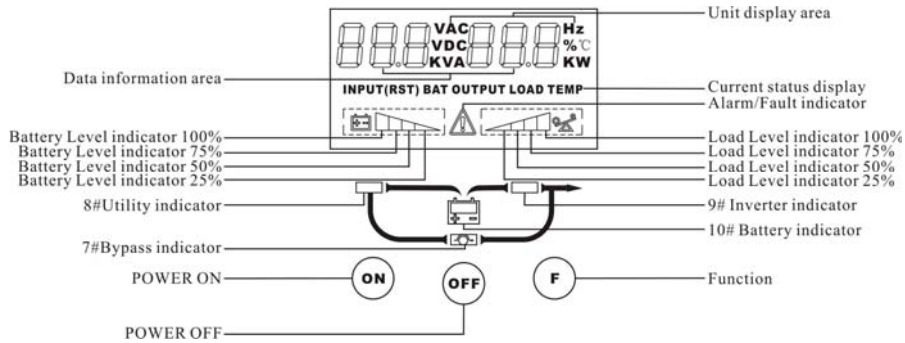

1. ON button:
Pressing the ON button more than 1 second (buzzer beeps once), the UPS system is turned on.
2. OFF button:
By pressing this button more than 1 second (buzzer beeps once) turns off the UPS system whenever the UPS run under the normal mode/battery mode.
3. Function button
The Function button provides the following functions:
 - a) Battery self- diagnosis: When the UPS ran in normal mode, pressing this button more than 5 seconds (buzzer beeps twice) can start the battery self-diagnosis.
 - b) Silence function in battery/bypass mode
In battery/bypass mode, when the buzzer beeps, pressing and holding the function button for more than 5 seconds (buzzer beeps two times) can silence the buzzer. Press the button for more than 5 seconds (buzzer beeps twice) again to resume the alarm function.
 - c) LCD display screen switch
Pressing the function button for more than 1 seconds (buzzer beeps once) to switch LCD display screen.
4. LED indicators
The LED indicators contains Fault indicator, Bypass indicator, utility power indicator, Inverter indicator, Battery indicator. The definition of each indicator is the same as LED panel (refer to table Appendix 1).

8. Chapter Operation (LCD model)

8.2 Operation Mode

UPS operation mode contains normal mode, battery mode and bypass mode. Under the three modes, the page showing output voltage and output frequency is the main display page. If users need more information about UPS, Pressing the function button can initiate display screen switch. If the current page is not the main page, UPS will auto switch back the main page after 30 seconds. In order to extend the LCD usage life, the backlight will turn off after 1 minute without any switch operation. At this point, Users just need to touch any button briefly, the backlight will be turn on.

8.2.1 Normal mode

When operating in the normal mode, the display of main page on the front panel is shown as the figure 8-2. The utility power indicator and the Inverter indicator are turn on. Load information area shows load value, and the battery level area indicates dynamically when the battery is not full charged (the battery level icons lit one after another circularly). When the battery is full charged, all the level icons are turn on.

- 1) If the utility power indicator blinks, it indicates that there are problems with reversed polarity (L, N) of site wiring or disconnect with ground. UPS is still working in normal mode. If the battery indicator is turn on at the same time, it shows that the voltage or frequency of the utility power is out of the normal input range of the UPS. The UPS works in battery mode.

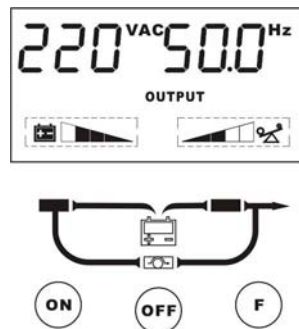

Figure 8-2 Normal Mode

8. Chapter Operation (LCD model)

- 2) If load is more than 105 percent, the buzzer beeps twice every second, meanwhile, the warning icon blinks every second too, reminding that you have been overloaded. You should get rid of some unnecessary loads one by one to decrease the loads until the alarm clear.
- 3) If the battery indicator blinks, it indicates that no battery is connected to the UPS or battery voltage is too low. You should check if battery is properly connected to the UPS, and press function button more than 5 seconds to start the battery self-diagnosis. If the connection between battery and UPS is confirmed without any problem, it may be due to the defect or aging of the battery, please refer to the “troubleshooting” in chapter 7 to solve the problem accordingly.
- 4) The other four display pages are load percent page, actual load page, input information page and the maximum temperature page.

Note: Connection to the power generator should be made according to the following steps:

- *Activate the power generator and wait until the operation is stable before connecting the output of the power generator to the UPS (be sure that the UPS is in idle mode). Then, turn on the UPS according to the startup procedure. After the UPS is turned on, the loads are connected one by one.*
- *It recommended that the capacity of the AC generator chosen should double that of the UPS.*

8.2.2 Battery Mode

When operating in the normal mode, the display of main page on the front panel is shown as the figure 8-3. The battery indicator and the Inverter indicator are turn on. If the utility power indicator blinks at the same time, it shows that the utility power is abnormal. Load information area shows load value, and bat level area shows current battery capacity.

- 1) When the UPS is running in battery mode, the alarm will beep every 4 seconds. If the “Function” key is pressed for more than 5 seconds, the alarm will not beep (silence function). Press the “Function” key more than 5 seconds again to resume the alarm function.

8. Chapter Operation (LCD model)

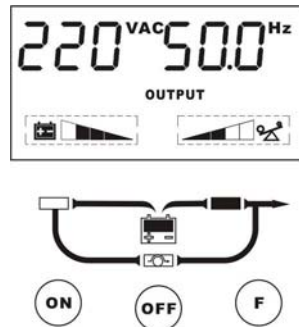

Figure 8-3 Battery Mode

- 2) When the battery capacity decreases, the number of load/battery capacity indicators turned on will decrease. If the battery voltage drops to the pre-alarm level (capable of maintaining the backup time for more than 2 minutes), the alarm will beep every second to remind the user of insufficient battery capacity.
- 3) The other four display pages are load percent page, actual load page, battery information page and the maximum temperature page.

8.2.3 Bypass Mode

When operating in bypass mode set up through UPSilon software, the display on the front panel is shown as the figure 8-4, the utility power indicator and the bypass indicator are turn on. The load/battery capacity indicator will be turned on in accordance with the load capacity connected. Load information area shows load value, and the battery level area indicates dynamically when the battery is not full charged (the battery level icons lit one after another circularly). When the battery is full charged, all the level icons are turn on.

- 1) When operating in bypass mode, the UPS beeps every 2 minutes. If the “Function” key is pressed for more than 5 seconds, the alarm will not beep (silence function). Press the “Function” key more than 5 seconds again to resume the alarm function.
- 2) If the utility power indicator blinks, it shows that the voltage or frequency of the utility power is out of the input range of the UPS or there are problems with reversed polarity (L/N) of site wiring or disconnect to the ground for protection.

8. Chapter Operation (LCD model)

- 3) The other four display pages are load percent page, actual load page, input information page and the maximum temperature page.

Notes: When operating in bypass mode, the backup function of the UPS is not available and the power used by the load is directly from the utility power via internal EMI filter.

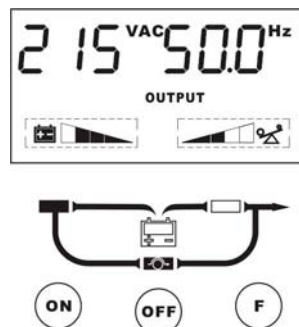

Figure 8-4 Bypass Mode

8.2.4 LCD indication of UPS alarm status and faults

In the event of an UPS fault, UPS enters fault operation mode, at this point, the fault icon turn on consistently, the buzzer beeps continuously and the data information area shows current fault code (refer to table 8.5-1), the display on the front panel is shown as the figure8-5.

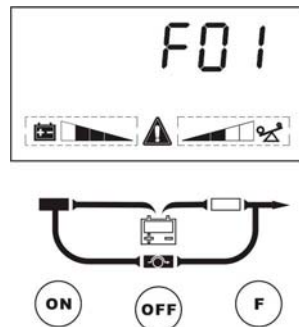

Figure 8-5 Fault display

8. Chapter Operation (LCD model)

When a warning occurred, the fault icon blinks every second, and users can switch to the alarm display page shown as the figure 8-6 to check the warning code.

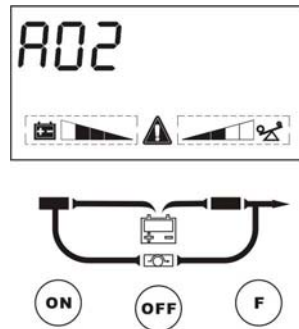

Figure 8-6 Alarm display

8.3 Operating Instructions

8.3.1 UPS ON/OFF Operation

Note: *The battery is fully charged before delivery. However, storage and transportation will inevitably cause some charge loss. Therefore, it is advisable to charge the battery for 10 hours before using it, so as to ensure adequate battery autonomy.*

1. Turning on the UPS

The operation of turning on the UPS contains: turning on with utility power and turning on without utility power.

1) Turning on with utility power:

Connect the mains input to the UPS, press the ON button more than one second, UPS start to turn on. At this point, the LCD begins to conduct self-diagnosis (all the LCD indicators are turn on about 4 seconds). Seconds later, the UPS will begin to operate in Normal mode; meanwhile, the utility power indicator, inverter indicators will turn on. If the utility power is abnormal, the UPS will work in battery mode.

2) Turning on without utility power:

With no mains input feed to the UPS, press the ON button more than one

8. Chapter Operation (LCD model)

second, UPS start to turn on, At this point, the LCD begins to conduct self-diagnosis (all the LCD indicators are turn on about 4 seconds). Seconds later, the battery indicator, inverter indicators will be turn on to indicate that the UPS is working in battery mode.

2. Powering down the UPS

The operation of powering down the UPS contains: turning off UPS in normal mode, turning off UPS in battery mode.

1) Completely power down the UPS from Normal mode

Hold and press the OFF button persistently for more than 1 second to power off the UPS. If it has been set up to work in bypass mode by software, the bypass indicator will be turn on to indicate that the UPS is working in bypass mode. In order to cut off the output from the UPS, simply cut off the utility power supply. LCD begins to conduct self-diagnosis (all the LCD indicators are turn on about 4 seconds), seconds later, not any display is shown on the front panel and no output is available from the UPS outlets, system completely power down.

2) Completely power down the UPS from Battery mode

Press the “OFF” button persistently for more than 1 second to power off the UPS. When being powered off, the LCD will start self-diagnosis (all the LCD indicators are turn on about 4 seconds), seconds later, not any display is shown on the front panel and no voltage output is available from the UPS outlets, system completely power down.

8.3.2 Conducting Battery self-diagnosis

In UPS operation, users can manually initiate battery self-diagnosis to check the battery conditions. There are two methods to initiate the battery self-diagnosis:

1. Through the function button

In normal mode, press and hold the function for more than 5 seconds until the buzzer beeps twice. At this point the indicators (LED7~10) will blink cyclically, indicating the UPS has worked in battery mode and the battery self-diagnosis has started. The battery self-diagnosis will last for 5 seconds default. In the event of a battery fault during battery self-diagnosis, the UPS will transfer to normal mode automatically.

8. Chapter Operation (LCD model)

2. Through the monitor software

Users can also initiate battery self-diagnosis through the background monitoring software.

8.4 Checking UPS function

Every time when conducting field maintenance, please check the regular function of the UPS, including:

1. Check the operation status of the UPS

If the main voltage is within the specifications, the UPS should operate in normal mode; if the main voltage is abnormal, the UPS should operate in battery mode. In both cases, there should be no fault indication.

2. Check the transfer between the UPS operation modes

Disconnect the main input to simulate a mains failure, the UPS should transfer to battery mode and operate normally; then recover the mains input, the UPS should transfer to normal mode and operate normally.

3. Check the LED indicators of the UPS

During the check processes stated above, check that the LED indication of the UPS agrees with the UPS operation mode.

8.5 Setting the output voltage and frequency

1) Connect the mains input to the UPS, and make the UPS works in standby mode or bypass mode.

2) Press the 'F' and 'OFF' button more than one second, then release, the buzzer will beep once, the "OUTPUT" is flashing, which means all of bottom are used for UPS setting, at this point, if the "VAC" is flashing, which means the output voltage is set to enable; if the "Hz" is flashing, which means the frequency is set to enable, the LCD screen indicator represents current output voltage and frequency setting value.

3) If you need to set the voltage, check the voltage setting is enabled ("VAC" is flashing). If not, press the 'F' more than one second, then release, the output setting is enabled, at this point you can start to set output voltage.

4) Release the 'OFF' key after you press it more than one second, LCD display the selected output voltage in turn.

5) Repeat the fourth step until the LCD indicator meets the required voltage.

8. Chapter Operation (LCD model)

- 6) Press 'ON' key about one second, the output voltage setting completed.
- 7) The frequency setting is the same as the voltage setting, but before the setting, please confirm the frequency setting is enabled, if not, press 'F' key about one second in order to switch to the frequency setting screen ("Hz" is flashing).
- 8) When done, Press the 'F' and 'OFF' button more than one second, then release, the buzzer will beep once, exit the setting mode.

In the setting process, if no key is detected within twenty second, the UPS exits the setting screen automatically.

8.6 Troubleshooting

In the event of an UPS fault, shoot the trouble according to Table8.5-1. If the fault still persists, please contact our customer service center.

Faults			Possible cause	Solution
Fault/Warning code	Fault icon	Alarm		
F01	On constantly	Beep continuously	Bus soft start fails	Please contact the distributor or Service center.
F02	On constantly	Beep continuously	BUS over voltage fault	Please contact the distributor or Service center.
F03	On constantly	Beep continuously	BUS low voltage fault	Please contact the distributor or Service center.
F05	On constantly	Beep continuously	Bus short	Please contact the distributor or Service center.
F06	On constantly	Beep continuously	INV soft start fails	Please contact the distributor or Service center.
F07	On constantly	Beep continuously	INV over voltage fault	Please contact the distributor or Service center.
F08	On constantly	Beep continuously	INV low voltage fault	Please contact the distributor or Service center.

8. Chapter Operation (LCD model)

Faults			Possible cause	Solution
Fault/ Warning code	Fault icon	Alarm		
F10	On constantly	Beep continuously	R INV short	Turn off the UPS. Remove all loads. Ensure that the loads are not failed or the UPS has no internal short before turn on it again. If failed, please contact the distributor or service center.
F17	On constantly	Beep continuously	R negative power fault	Please contact the distributor or Service center.
F21	On constantly	Beep continuously	React power fault	Please contact the distributor or Service center.
F22	On constantly	Beep continuously	Over load fault	Please contact the distributor or Service center.
F23	On constantly	Beep continuously	Over heat fault	Please contact the distributor or Service center.
F24	On constantly	Beep continuously	INV Rly open fault	Please contact the distributor or Service center.
F25	On constantly	Beep continuously	INV Rly stick fault	Please contact the distributor or Service center.
F26	On constantly	Beep continuously	Line input SCR fault	Please contact the distributor or Service center.
F32	On constantly	Beep continuously	Parallel line loss	Please check parallel line connect or not.
F34	On constantly	Beep continuously	CAN parallel line loss	Please contact the distributor or Service center.
F35	On constantly	Beep continuously	Synchronous signal fault	Please contact the distributor or Service center.
F36	On constantly	Beep continuously	Power supply fault	Please contact the distributor or Service center.
F42	On constantly	Beep continuously	Line input fuse open fault	Please contact the distributor or Service center.
F55	On constantly	Beep continuously	NTC fault	Please contact the distributor or Service center.
F57	On constantly	Beep continuously	Battery fault	Please contact the distributor or Service center.
F59	On constantly	Beep continuously	Over charge fault	Please contact the distributor or Service center.

8. Chapter Operation (LCD model)

Faults			Possible cause	Solution
Fault/ Warning code	Fault icon	Alarm		
A04	Blink once every second	4min beep one sound	Line fail	Please check line voltage.
A07	Blink once every second	2min beep one sound	Reversed polarity of LAN	Please check the polarity of the neutral wiring and the line wiring.
A08	Blink once every second	1 sound /4s	Bypass fail	Please check line voltage.
A10	Blink once every second	Beep one sound every second	Battery unconnected	Please check battery line connect or not.
A11	Blink once every second	Beep one sound every second	Battery voltage low	The UPS output will be cut off, please switch to the backup power.
A12	Blink once every second	Beep continuously	Battery overcharging	Please contact the distributor or Service center.
A14	Blink once every second	Beep two sounds every second	Overload pre-warning	Reduce the member of loads connected to the UPS.
A15	Blink once every second	Beep two sounds every second	Overload fault	Reduce the member of loads connected to the UPS.
A16	Blink once every second	Beep one sound every second	Fan failure	Ensure that the fan is not locked
A18	Blink once every second	Beep one sound every second	Charger fail	Please contact the distributor or Service center.
A20	Blink once every second	Beep 3 sounds	Start UPS fail	Please check the battery cables connect or not.
A33	Blink once every second	No beep	Parallel mode fault	Please contact the distributor or Service center.
A34	Blink once every second	1.5s beep 1 sounds total 3 sounds	Eeprom fault	Please contact the distributor or Service center.
A35	Blink once every second	Beep continuously	ID repetition	Please contact the distributor or Service center.
A53	Blink once every second	Beep continuously	Unrecognized UPS model	Please contact the distributor or Service center.
A61	Blink once every second	Beep continuously	Slave PSDR fault	Please contact the distributor or Service center.

Table 8.5-1 UPS troubleshooting of LCD panel indicator

8. Chapter Operation (LCD model)

When you contact the service center, please provide the following information:

- Model No and Serial No of the UPS.
- The date when the problem arose.
- Complete description of the problem, including the panel display, alarm warning, and power condition and the load capacity. If the UPS is a long backup time model, you may also provide the battery information.