

SIT305 Photo Interrupter

The SIT305 is a photointerrupter high-performance standard type, combines high-output GaAs IRED with high sensitive phototransistor.

Features

- PCB direct mount type
- GAP:3.0mm
- With the installation positioning boss
- Compact/High performance
- RoHS Compliance

Applications

- Printers
- FAX
- Copiers
- Car stereo
- Amusement machines

Dimensions

(Unit: mm)

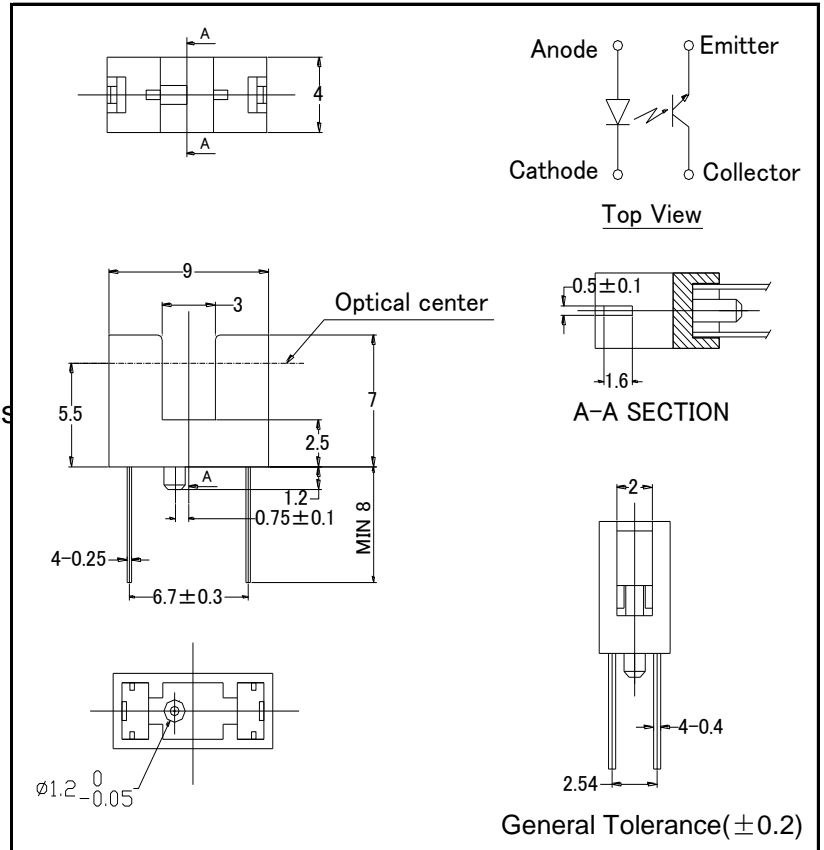

MAXIMUM RATINGS

(Ta = 25°C)

Item		Symbol	Ratings	Unit
Input	Power dissipation	P_D	75	mW
	Forward current	I_F	50	mA
	Reverse voltage	V_R	5	V
Output	Collector power dissipation	P_C	75	mW
	Collector current	I_C	20	mA
	Collector-Emitter voltage	V_{CEO}	30	V
	Emitter-Collector voltage	V_{ECO}	5	V
Operating temperature		Topr.	-20 ~ +85	°C
Storage temperature		Tstg.	-30 ~ +85	°C
Soldering temperature ^{*1}		Tsol.	260	°C

* 1 The soldering should be 1mm away from bottom of the holder. t=within 3s

Photo Interrupter

SIT305

Electro-Optical Characteristics

($T_a=25^\circ\text{C}$)

Item		Symbol	Conditions	Min	Typ	Max	Unit
Input	Forward voltage	V_F	$I_F=20\text{mA}$	-	1.2	1.4	V
	Reverse current	I_R	$V_R=5\text{V}$	-	-	10	μA
	Peak wavelength	λ_p	$I_F=20\text{mA}$	-	940	-	nm
Output	Dark current	I_{CEO}	$V_{CE}=10\text{V}, E_V=0\text{lX}$	-	1	100	nA
Transfer characteristics	Light current	I_C	$I_F=20\text{mA}, V_{CE}=5\text{V}, \text{Non-shading}$	0.7	-	14	mA
	Leak current	I_{CEOD}	$I_F=20\text{mA}, V_{CE}=5\text{V}, \text{Shading}$	-	0.5	10	μA
	C-E saturation voltage	$V_{CE(sat)}$	$I_F=20\text{mA}, I_C=0.1\text{mA}$	-	0.15	0.4	V
	Rise time	tr	$I_C=0.5\text{mA}, V_{CC}=10\text{V}, R_L=100\Omega$	-	10	-	μs
	Fall time	tf		-	15	-	μs

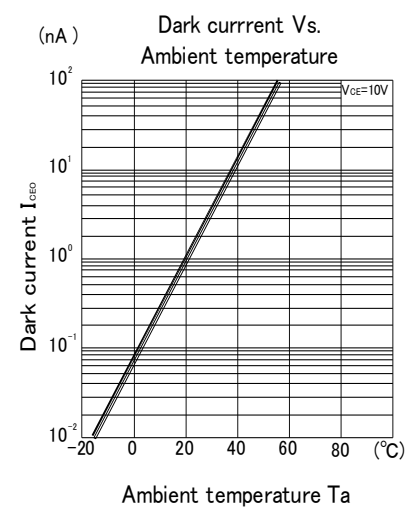
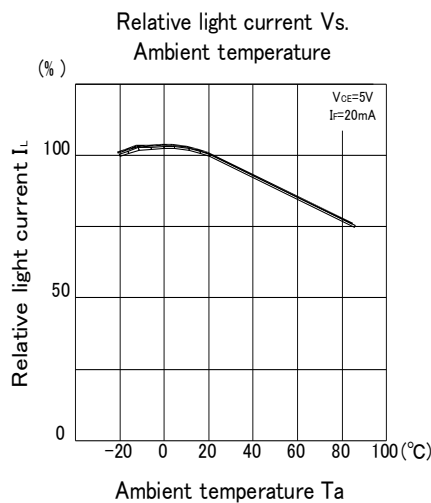
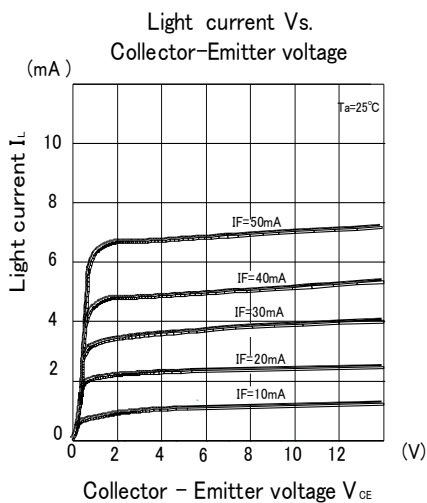
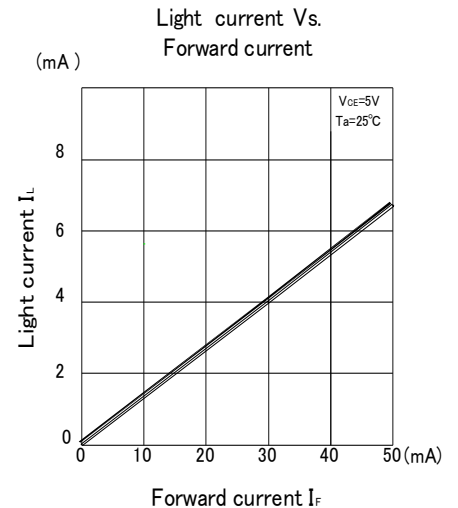
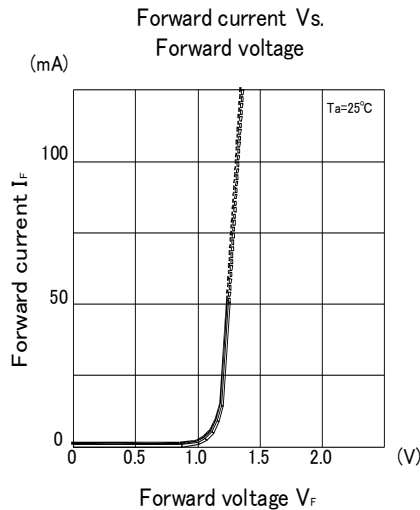
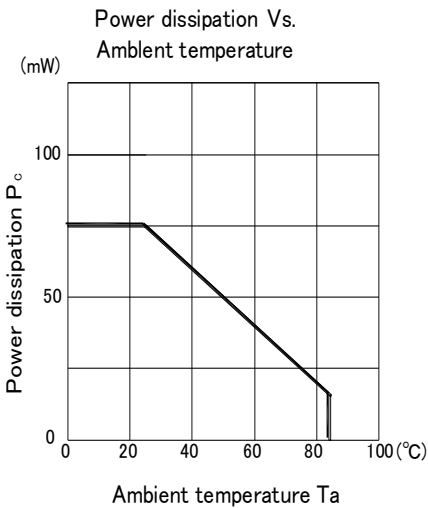
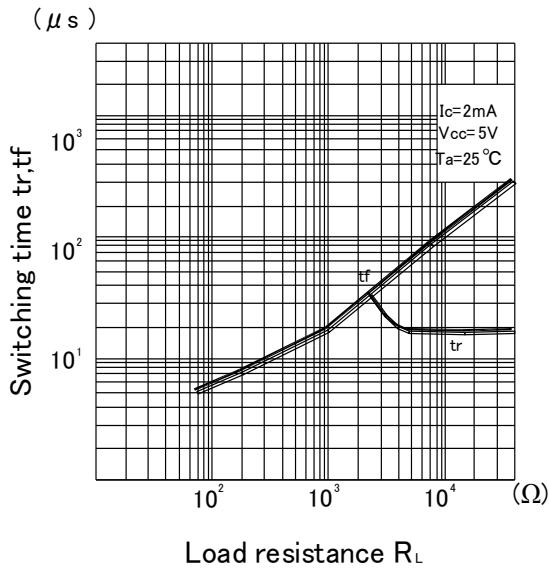

Photo Interrupter

SIT305

Switching time Vs. Load resistance ※1



Relative output current Vs. Moving distance ※2

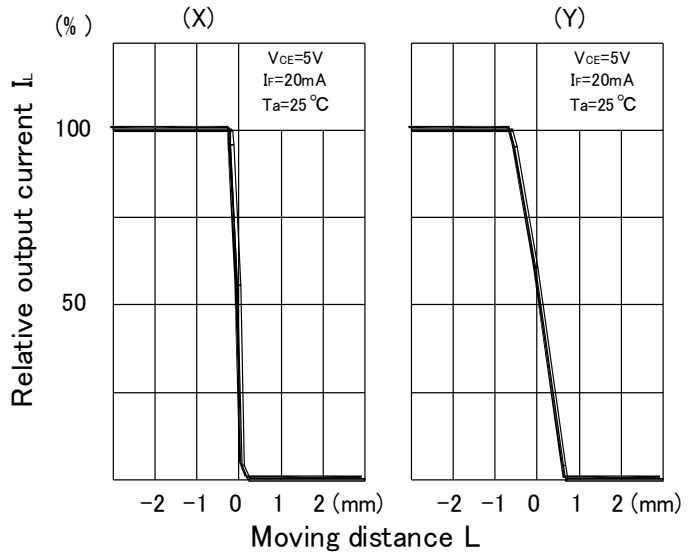

※1 Switching time measurement circuit

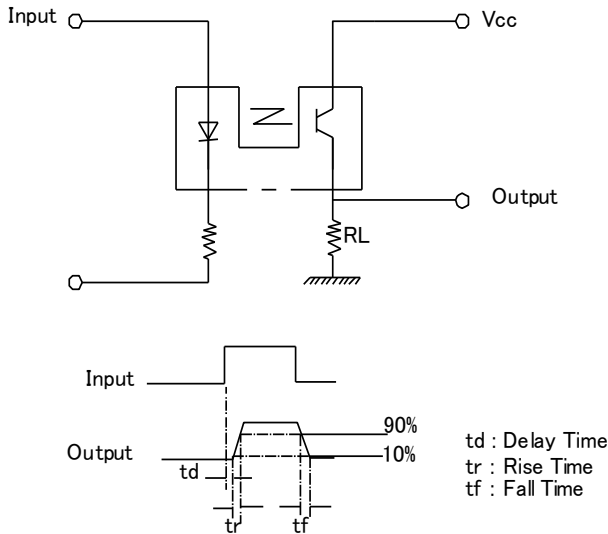

※2 Method of measuring position detection characteristic

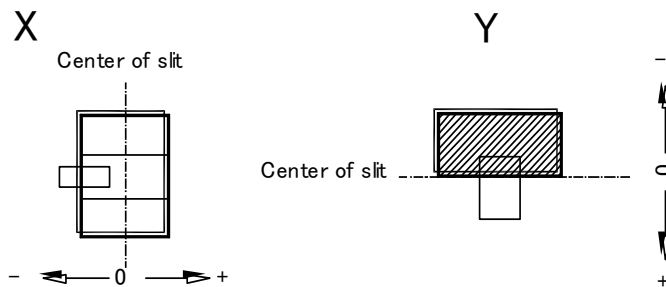

Packing Specification

- 1.Fixed quantity (max 1000pcs) of the products are packed into plastic bag
- 2.Ten bags of the products are put into #2 box
- 3.Two #2 boxes are put into #3 box(max 20000pcs)
- 4.Packing slip is pasted on #3 box

