

PRODUCT SPECIFICATION

Model No.: FYLS-0603BXXC

| Features: |
|----------------------------------------------------------------------------------------------------------------------------------------------------------------------------------------------------------------------------------------------------------------------------------------------------------------------------------------------------------------------|
| <ul style="list-style-type: none"> ■ SMD Type ■ Size (mm):1.60*0.80*0.60 ■ Lens Color: Water clear. ■ Viewing Angle(2θ^{1/2}):130° ■ SMT package ■ Suitable for all SMT assembly and soldering method ■ Pb-free Reflow soldering application ■ RoHS Compliant ■ MSL:4 |

| Applications: |
|---------------------------------------------------------------------------------------------------------------------------------------------------------------------------------------------------------------------------------|
| <ul style="list-style-type: none"> ■ Light Strips ■ LCD Backlight ■ Decorative lighting ■ Indicators ■ Interior automotive ■ Illuminations ■ Mobile Phones |



| CUSTOMER APPROVED SIGNATURES | APPROVED BY | CHECKED BY | PREPARED BY |
|------------------------------|-------------|------------|-------------|
| | | | |

NINGBO FORYARD OPTOELECTRONICS CO.,LTD.

Add:No. 666 Jinghua Road, Hi-tech Park, Ningbo, Zhejiang, China

Zip:315103

Tel: 0086-574-87933652 87927870

Fax: 0086-574-87927917

E-mail:Sales@foryard.com (General)

Model No.: FYLS-0603BXXXC

■ Mechanical Dimensions

● Positive polarity

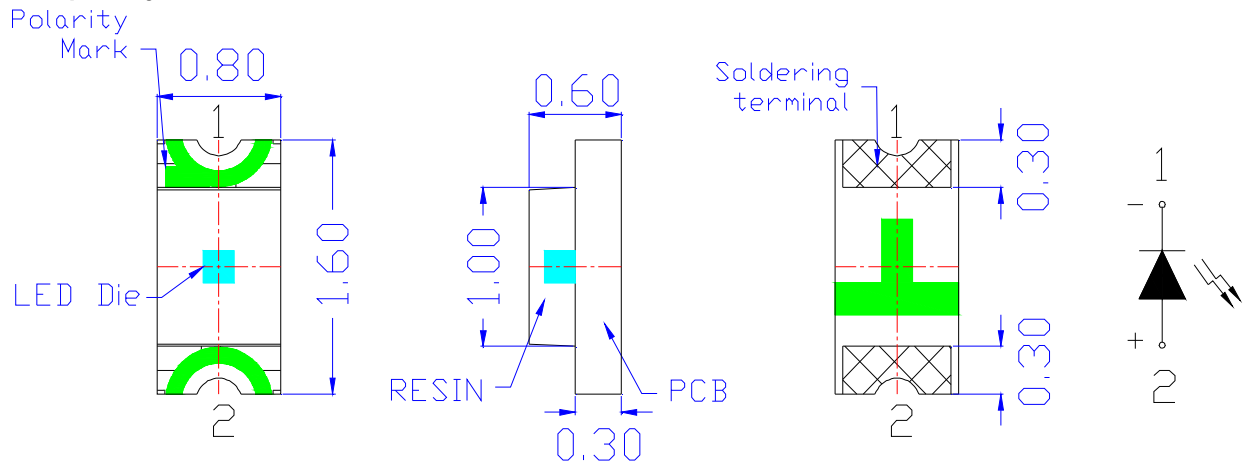

FYLS-0603BKURC, FYLS-0603BSURC, FYLS-0603BKUEC, FYLS-0603BKUYC
 FYLS-0603BKUGC, FYLS-0603BSUGC, FYLS-0603BPGC, FYLS-0603BUBC

● Reverse polarity

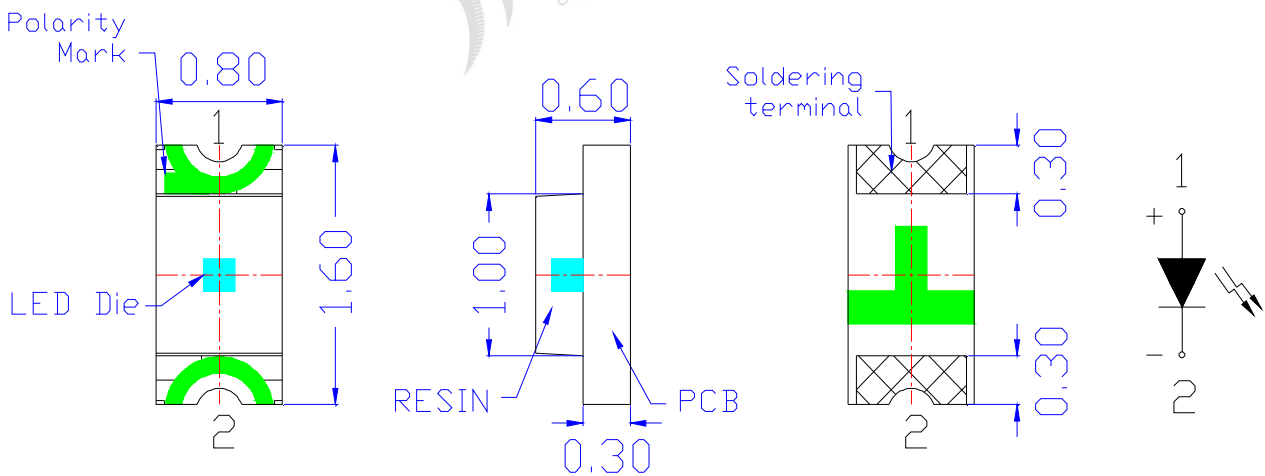

FYLS-0603BSCURC, FYLS-0603BPURC, FYLS-0603BPUAC, FYLS-0603BPUYC

■ Recommend Soldering pad design(unit=mm)

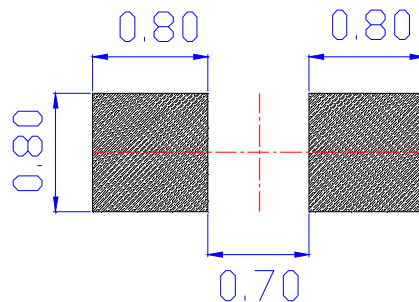

Notes:

1. Dimension in millimeter, tolerance is ± 0.10 .
2. Angle: $\pm 5^\circ$
3. The specifications, characteristics and technical data described in the datasheet are subject to change without prior notice.
4. The drawing is different from the actual one, please refer to the sample.

Model No.: FYLS-0603BXXXC

■ Absolute maximum ratings

| Parameter | Symbol | MAX. | | | | | Unit |
|-----------------------------|--------|----------|-----|--------|---------|-----------|------|
| | | GaAsP | GaP | AlGaAs | AlGaInP | InGaN/GaN | |
| Power Dissipation | PD | 78 | 80 | 69 | 78 | 100 | mW |
| Peak Forward Current* | IFP | 100 | 100 | 100 | 100 | 100 | mA |
| Continuous Forward Current | IF | 25 | 25 | 25 | 25 | 25 | mA |
| Reverse Voltage | VR | 5 | | | | | V |
| Reverse Current (VR=5V) | IR | 10 | | | | | u A |
| Operating Temperature Range | Topr | -40~ +85 | | | | | ℃ |
| Storage Temperature Range | Tstg | -40~ +85 | | | | | ℃ |

*1/10 Duty Cycle, 0.1ms Pulse Width

■ Electrical-Optical Characteristics

● Color Code & Chip Characteristics:(Test Condition : If=20mA,Ta=25℃)

| Model No.: | Emitting Color | Dice Material | Peak Wave | Dominant Wave | | | Spectral Line halfwidth (Δλ1/2) nm | Forward Voltage(VF) Unit:V | | | Luminous Intensity (Iv) Unit:mcd | | |
|-------------------------|--------------------|---------------|------------------|---------------|-------|------|------------------------------------------|-------------------------------|------|------|-------------------------------------|------|------|
| | | | Length(λP) nm | Min. | Typ. | Max. | | Min. | Typ. | Max. | Min. | Typ. | Max. |
| Ultra brightness | | | | | | | | | | | | | |
| FYLS-0603BKURC | Ultra Red | AlGaInP | 645 | 623 | 632 | 640 | 20 | 1.70 | 2.00 | 2.40 | 57 | 90 | 145 |
| FYLS-0603BSURC | Ultra Red | AlGaInP | 645 | 623 | 632 | 640 | 20 | 1.70 | 2.00 | 2.40 | 72 | 115 | 180 |
| FYLS-0603BSCURC | Ultra Red | AlGaInP | 645 | 623 | 632 | 640 | 20 | 1.70 | 2.00 | 2.40 | 180 | 225 | 360 |
| FYLS-0603BPURC | Ultra Red | AlGaInP | 645 | 623 | 632 | 640 | 20 | 1.70 | 2.00 | 2.40 | 225 | 300 | 450 |
| FYLS-0603BKUEC | Ultra Orange | AlGaInP | 625 | 614 | 622 | 627 | 30 | 1.70 | 2.00 | 2.40 | 72 | 115 | 145 |
| FYLS-0603BPUAC | Ultra Amber | AlGaInP | 610 | 598 | 606 | 610 | 20 | 1.70 | 2.00 | 2.40 | 225 | 300 | 450 |
| FYLS-0603BKUYC | Ultra Yellow | AlGaInP | 593 | 586 | 590 | 594 | 20 | 1.70 | 2.00 | 2.40 | 57 | 90 | 145 |
| FYLS-0603BPUYC | Ultra Yellow | AlGaInP | 593 | 586 | 590 | 594 | 20 | 1.70 | 2.00 | 2.40 | 225 | 300 | 450 |
| FYLS-0603BKUGC | Ultra Yellow Green | AlGaInP | 570 | 568 | 572 | 576 | 30 | 1.70 | 2.00 | 2.40 | 18 | 28.5 | 45 |
| FYLS-0603BSUGC | Ultra Yellow Green | AlGaInP | 570 | 568 | 572 | 576 | 30 | 1.70 | 2.00 | 2.40 | 22.5 | 36 | 57 |
| FYLS-0603BPGC | Purea Green | InGaN/GaN | 520 | 514 | 521.5 | 529 | 36 | 2.60 | 3.00 | 3.50 | 360 | 450 | 950 |
| FYLS-0603BUBC | Ultra Blue | InGaN/GaN | 468 | 463.5 | 470 | 476 | 30 | 2.60 | 3.00 | 3.50 | 90 | 145 | 225 |

■ Material

| Item | Reflector | Wire | Encapsulate |
|----------|-----------|------|-------------|
| Material | / | Gold | Epoxy |

Note:

- 1.Luminous Intensity is based on the Foryard standards.
- 2.Pay attention about static for InGaN

Model No.: FYLS-0603BXXXX

■ The Luminous Intensity Grade of Products(Unit: mcd) ;Test Condition: If=20mA,Ta=25℃

| A | | B | | C | | D | | E | | F | |
|------|------|------|------|------|------|------|------|------|-------|-------|-------|
| A1 | A2 | B1 | B2 | C1 | C2 | D1 | D2 | E1 | E2 | F1 | F2 |
| 0.10 | 0.20 | 0.40 | 0.70 | 1.20 | 2.20 | 3.60 | 5.10 | 7.20 | 9.00 | 11.50 | 14.50 |
| | | | | | | | | | | | |
| 0.20 | 0.40 | 0.70 | 1.20 | 2.20 | 3.60 | 5.10 | 7.20 | 9.00 | 11.50 | 14.50 | 18.00 |

| G | | H | | J | | K | | L | | M | |
|-------|-------|-------|-------|-------|-------|-------|--------|--------|--------|--------|--------|
| G1 | G2 | H1 | H2 | J1 | J2 | K1 | K2 | L1 | L2 | M1 | M2 |
| 18.00 | 22.50 | 28.50 | 36.00 | 45.00 | 57.00 | 72.00 | 90.00 | 115.00 | 145.00 | 180.00 | 225.00 |
| | | | | | | | | | | | |
| 22.50 | 28.50 | 36.00 | 45.00 | 57.00 | 72.00 | 90.00 | 115.00 | 145.00 | 180.00 | 225.00 | 285.00 |

| N | | P | | Q | | R | | SA | | SB | |
|--------|--------|--------|--------|--------|--------|--------|---------|---------|---------|---------|---------|
| N1 | N2 | P1 | P2 | Q1 | Q2 | R1 | R2 | S1 | S2 | S3 | S4 |
| 285.00 | 360.00 | 450.00 | 550.00 | 650.00 | 750.00 | 850.00 | 950.00 | 1050.00 | 1150.00 | 1250.00 | 1350.00 |
| | | | | | | | | | | | |
| 360.00 | 450.00 | 550.00 | 650.00 | 750.00 | 850.00 | 950.00 | 1050.00 | 1150.00 | 1250.00 | 1350.00 | 1450.00 |

| SC | | TA | | TB | | TC | | UA | | UB | |
|---------|---------|---------|---------|---------|---------|---------|---------|---------|---------|---------|---------|
| S5 | S6 | T1 | T2 | T3 | T4 | T5 | T6 | U1 | U2 | U3 | U4 |
| 1450.00 | 1550.00 | 1650.00 | 1750.00 | 1850.00 | 1950.00 | 2050.00 | 2250.00 | 2450.00 | 2650.00 | 2850.00 | 3050.00 |
| | | | | | | | | | | | |
| 1550.00 | 1650.00 | 1750.00 | 1850.00 | 1950.00 | 2050.00 | 2250.00 | 2450.00 | 2650.00 | 2850.00 | 3050.00 | 3350.00 |

| UC | | VA | | VB | | VC | | WA | | WB | |
|---------|---------|---------|---------|---------|---------|---------|---------|---------|---------|---------|---------|
| U5 | U6 | V1 | V2 | V3 | V4 | V5 | V6 | W1 | W2 | W3 | W4 |
| 3350.00 | 3650.00 | 3950.00 | 4250.00 | 4650.00 | 5050.00 | 5550.00 | 6050.00 | 6650.00 | 7250.00 | 7950.00 | 8650.00 |
| | | | | | | | | | | | |
| 3650.00 | 3950.00 | 4250.00 | 4650.00 | 5050.00 | 5550.00 | 6050.00 | 6650.00 | 7250.00 | 7950.00 | 8650.00 | 9450.00 |

| WC | | XA | | XB | | XC | |
|----------|----------|----------|----------|----------|----------|----------|----------|
| W5 | W6 | X1 | X2 | X3 | X4 | X5 | X6 |
| 9450.00 | 10250.00 | 11250.00 | 13250.00 | 16250.00 | 19250.00 | 23250.00 | 27250.00 |
| | | | | | | | |
| 10250.00 | 11250.00 | 13250.00 | 16250.00 | 19250.00 | 23250.00 | 27250.00 | 32250.00 |

Tolerance of measurement of luminous intensity is $\pm 15\%$

■ Forward Voltage Grade of Products (Unit: V); Test Condition: If=20mA,Ta=25℃

| 1 | 2 | 3 | 4 | 5 | 6 | 7 | 8 | 9 | 10 | 11 | 12 |
|------|------|------|------|------|------|------|------|------|------|------|------|
| 1.40 | 1.50 | 1.60 | 1.70 | 1.80 | 1.90 | 2.00 | 2.10 | 2.20 | 2.30 | 2.40 | 2.50 |
| | | | | | | | | | | | |
| 1.50 | 1.60 | 1.70 | 1.80 | 1.90 | 2.00 | 2.10 | 2.20 | 2.30 | 2.40 | 2.50 | 2.60 |

| 13 | 14 | 15 | 16 | 17 | 18 | 19 | 20 | 21 | 22 | 23 | 24 |
|------|------|------|------|------|------|------|------|------|------|------|------|
| 2.60 | 2.70 | 2.80 | 2.90 | 3.00 | 3.10 | 3.20 | 3.30 | 3.40 | 3.50 | 3.60 | 3.70 |
| | | | | | | | | | | | |
| 2.70 | 2.80 | 2.90 | 3.00 | 3.10 | 3.20 | 3.30 | 3.40 | 3.50 | 3.60 | 3.70 | 3.80 |

Tolerance of measurement of forward voltage is $\pm 0.1V$

Model No.: FYLS-0603BXXXC

■ Dominate Wavelength Grade of Products (Unit: nm); Test Condition: If=20mA, Ta=25°C

| Red/Ultra Red | | | |
|---------------|--------|--------|--------|
| UR | | | |
| 0 | 1 | 2 | 3 |
| 620.00 | 623.00 | 627.00 | 632.00 |
| | | | |
| 623.00 | 627.00 | 632.00 | 640.00 |

| Ultra Orange | | | |
|--------------|--------|--------|--------|
| UE | | | |
| 1 | 2 | 3 | 4 |
| 614.00 | 618.00 | 622.00 | 627.00 |
| | | | |
| 618.00 | 622.00 | 627.00 | 632.00 |

| Ultra Amber | | | |
|-------------|--------|--------|--------|
| UA | | | |
| 1 | 2 | 3 | 4 |
| 598.00 | 602.00 | 606.00 | 610.00 |
| | | | |
| 602.00 | 606.00 | 610.00 | 614.00 |

| Ultra Yellow | | | | | |
|--------------|--------|--------|--------|--------|--------|
| UY | | | | | |
| 1 | 2 | 3 | 4 | 5 | 6 |
| 584.00 | 586.00 | 588.00 | 590.00 | 592.00 | 594.00 |
| | | | | | |
| 586.00 | 588.00 | 590.00 | 592.00 | 594.00 | 596.00 |

| Ultra Yellow Green | | | | |
|--------------------|--------|--------|--------|--------|
| UG | | | | |
| 0 | 1 | 2 | 3 | 4 |
| 568.00 | 570.00 | 572.00 | 574.00 | 576.00 |
| | | | | |
| 570.00 | 572.00 | 574.00 | 576.00 | 578.00 |

| Purea Green | | | | | | | | | |
|-------------|--------|--------|--------|--------|--------|--------|--------|--------|--------|
| PG | | | | | | | | | |
| 1 | 2 | 3 | 4 | 5 | 6 | 7 | 8 | 9 | A |
| 511.50 | 514.00 | 516.50 | 519.00 | 521.50 | 524.00 | 526.50 | 529.00 | 531.50 | 534.00 |
| | | | | | | | | | |
| 514.00 | 516.50 | 519.00 | 521.50 | 524.00 | 526.50 | 529.00 | 531.50 | 534.00 | 536.50 |

| Ultra Blue | | | | | |
|------------|--------|--------|--------|--------|--------|
| UB | | | | | |
| 0 | 1 | 2 | 3 | 4 | 5 |
| 460.00 | 463.50 | 466.00 | 468.50 | 471.00 | 473.50 |
| | | | | | |
| 463.50 | 466.00 | 468.50 | 471.00 | 473.50 | 476.00 |

Tolerance for each Dominate Wavelength bin is ±1nm



Model No.: FYLS-0603BXXXC

Electrical-Optical Characteristics-

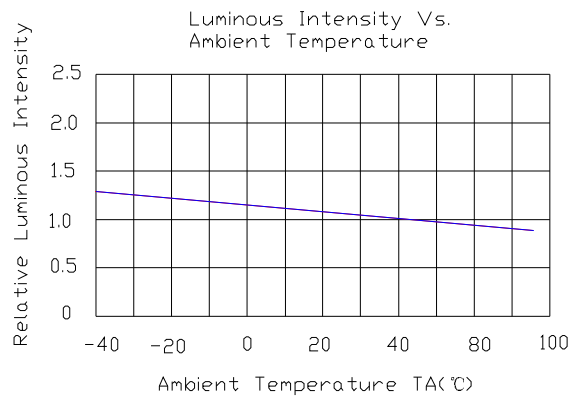
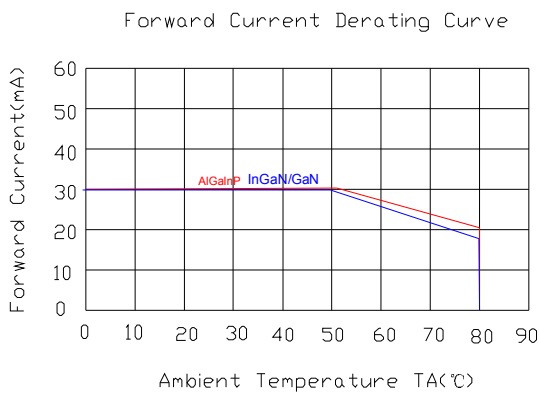
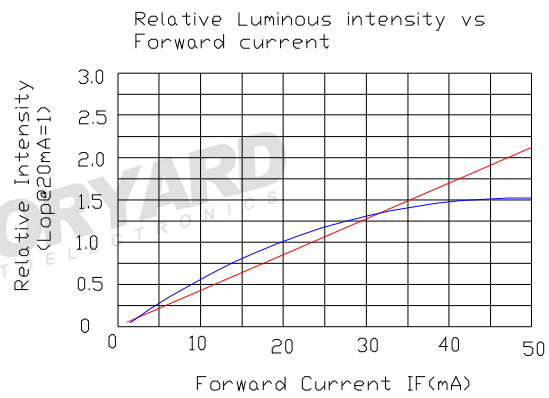
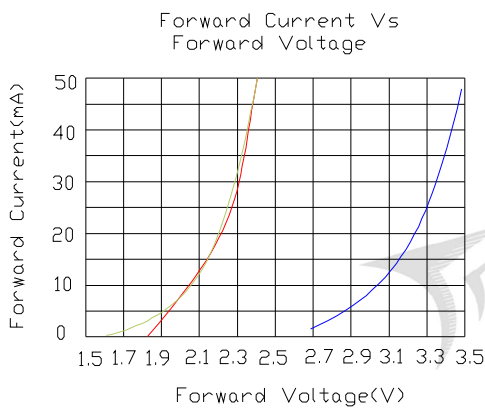
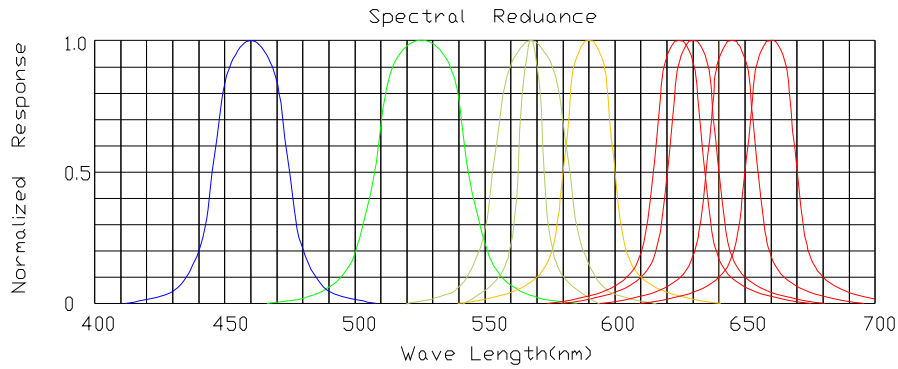

NOTE:25°C free air temperature unless otherwise specified

Radiation pattern-

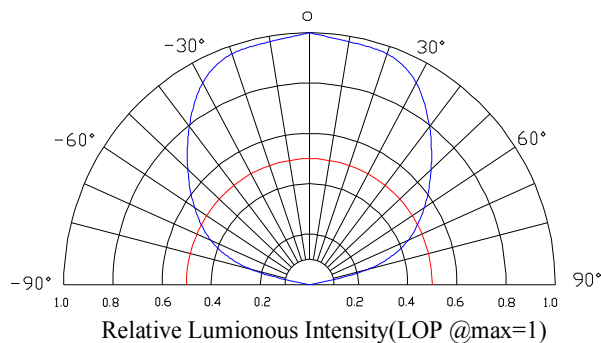

Model No.: FYLS-0603BXXXC

Package-

1. Reel Dimension

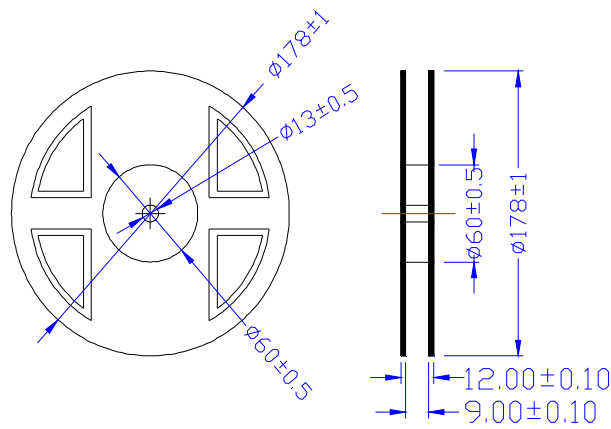

2. Tape Dimension

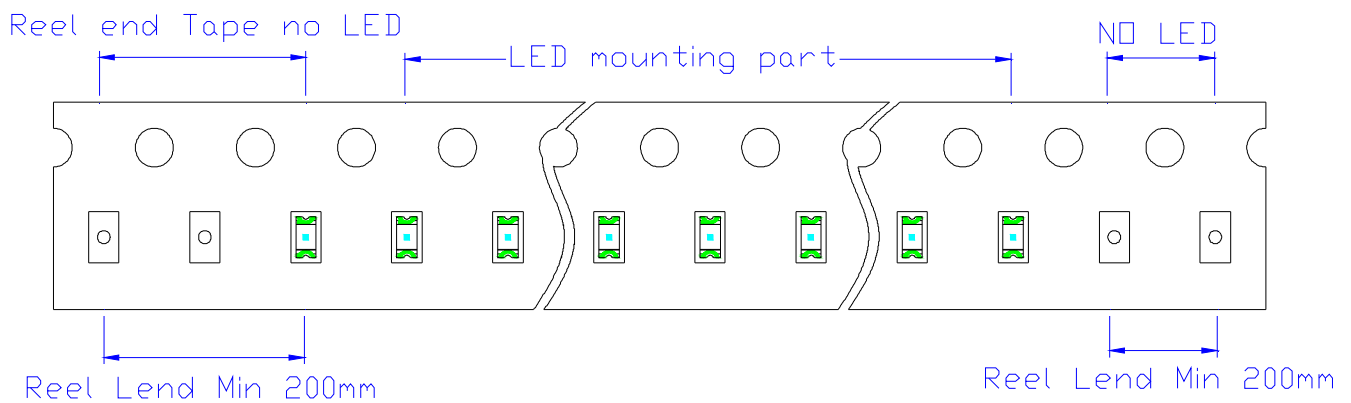
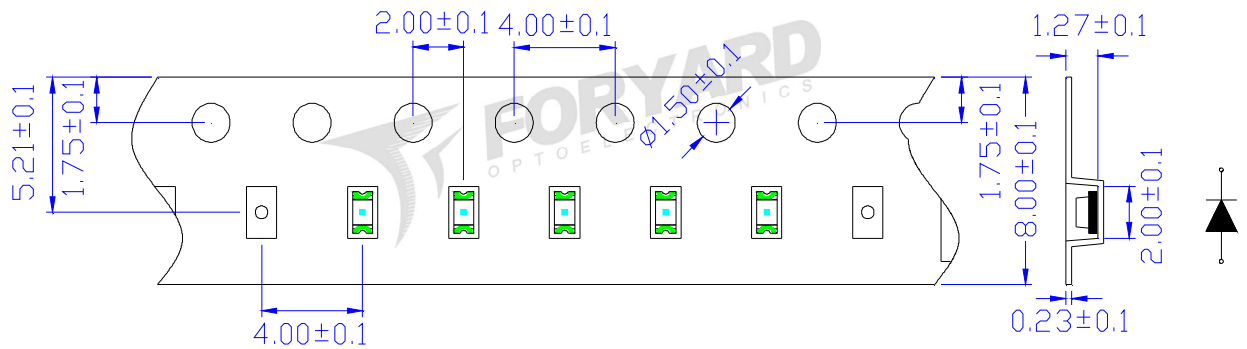

FYLS-0603BKURC, FYLS-0603BSURC, FYLS-0603BKUEC, FYLS-0603BKUYC
 FYLS-0603BKUGC, FYLS-0603BSUGC, FYLS-0603BPGC, FYLS-0603BUBC

Notice:

1. Tolerance unless mentioned is $\pm 0.2\text{mm}$

Model No.: FYLS-0603BXXXC

Package-

1. Reel Dimension

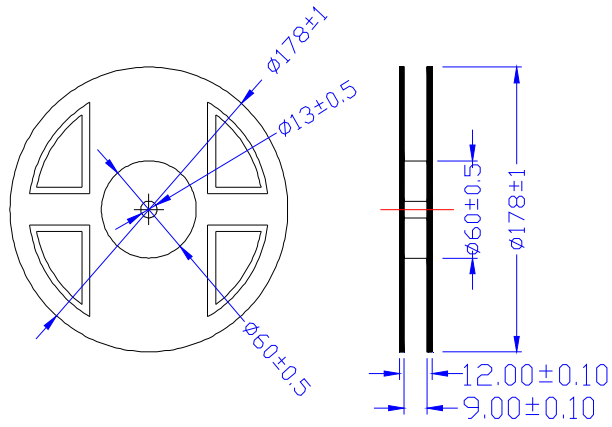

2. Tape Dimension

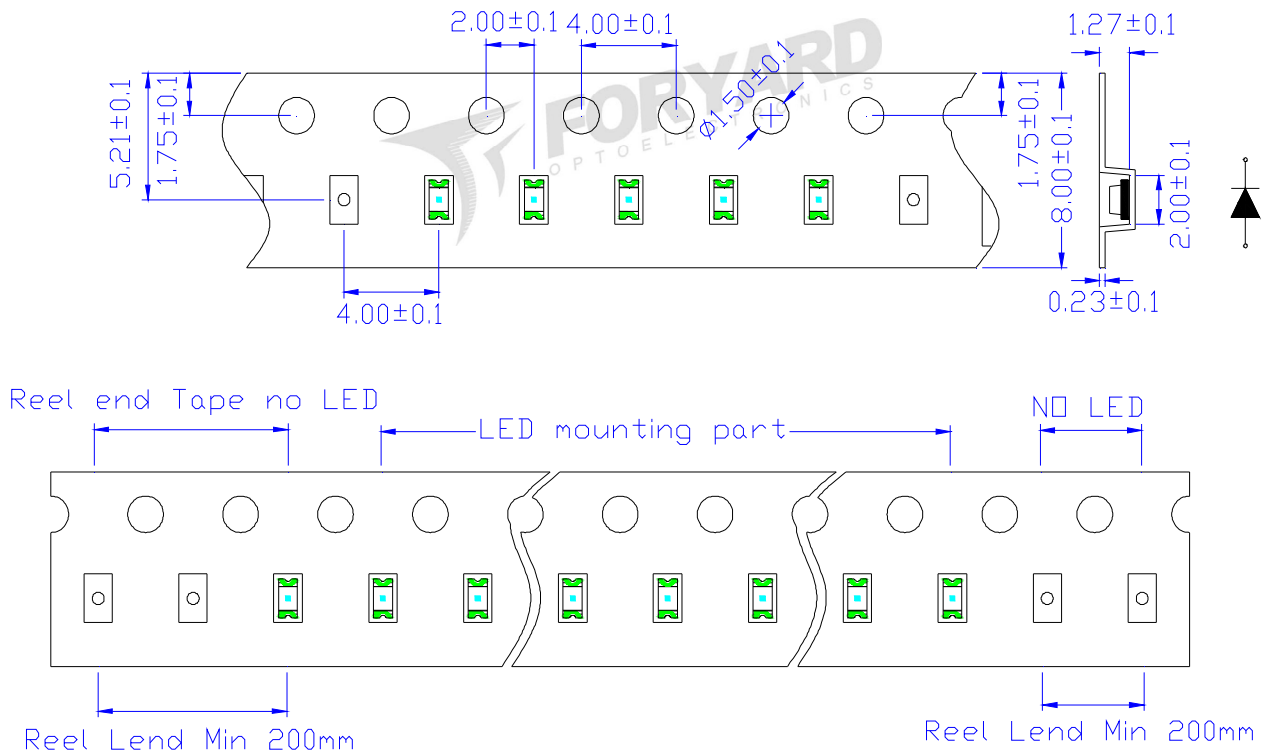



FYLS-0603BPURC, FYLS-0603BPUAC, FYLS-0603BPUYC

Notice:

1. Tolerance unless mentioned is $\pm 0.2\text{mm}$

Model No.: FYLS-0603BXXXC

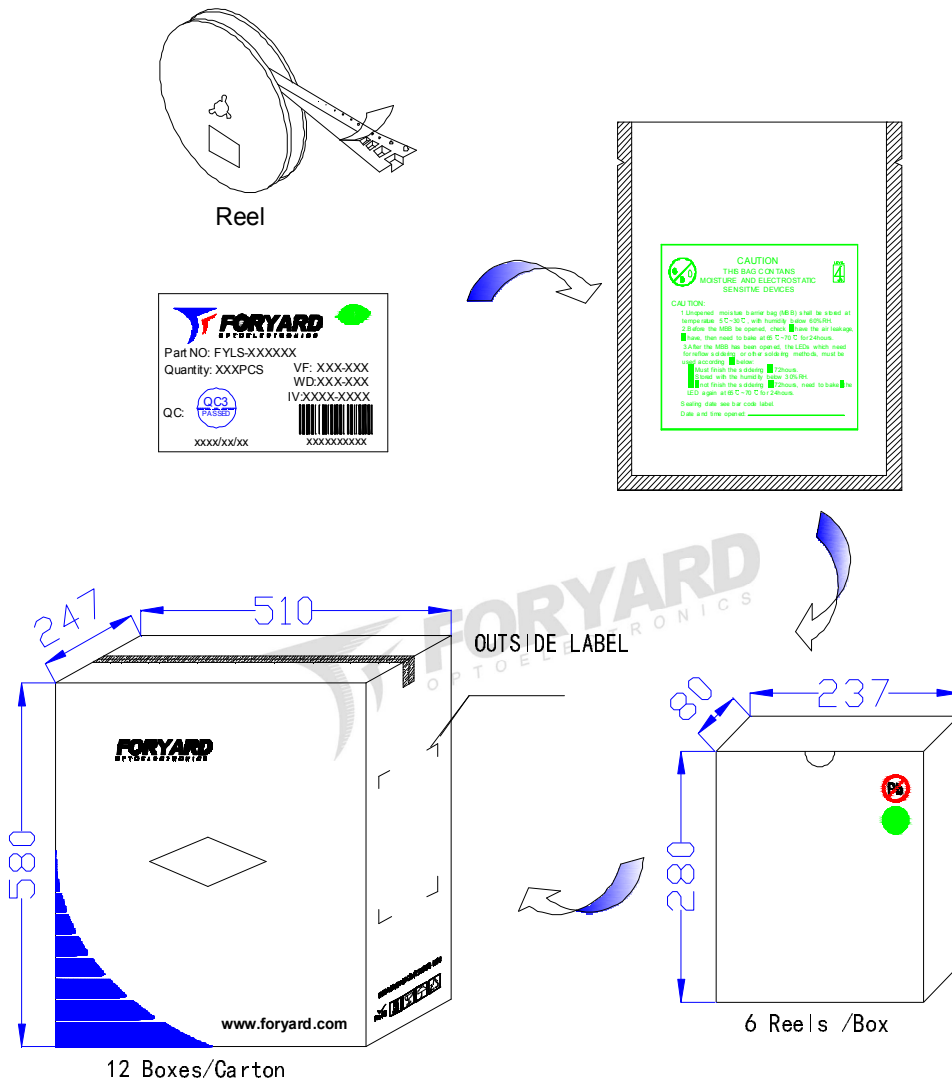

3. Packing Diagram

LED
PN: FYLS-XXXXXXXXXX
Qty: XXXX PCS
Date: XXXX/XX/XX
GW: XX.XX KG
NW: XX.XX KG



XXXXXXXXXX

OUTSIDE LABEL

Notice:

- 1.Quantity:4000 PCS/Reel
- 2.The specifications are subject to change without notice. Please contact us for updated information.

Model No.: FYLS-0603BXXXC

■ Soldering Characteristics-

● Reflow Soldering

● Lead Solder

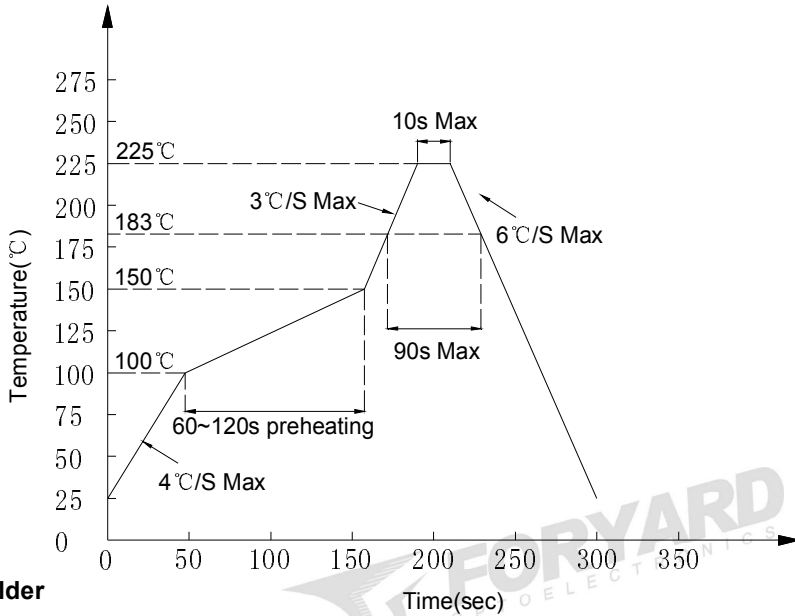

● Lead-free Solder

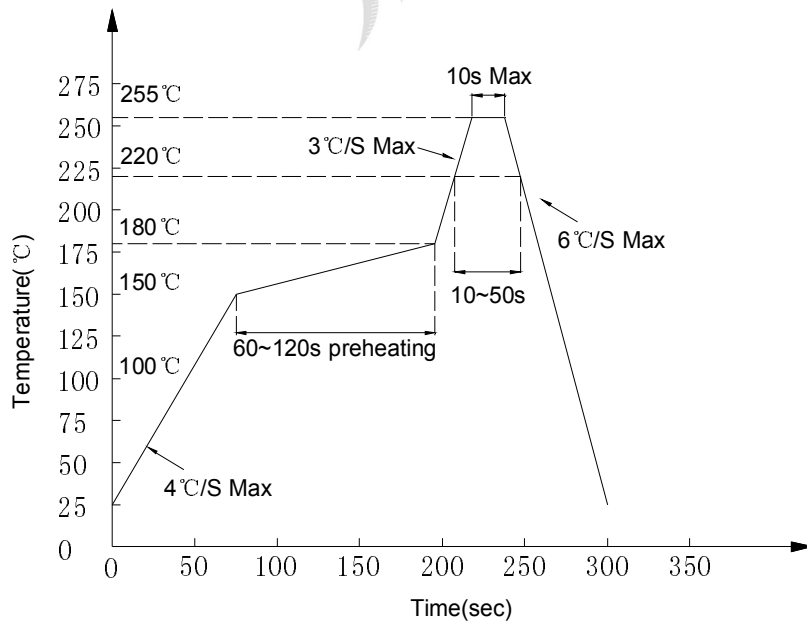

Notes:

1. Although the recommended soldering conditions are specified in above table, reflow or hand soldering at the lowest possible temperature is desired for the LEDs.
2. A rapid-rate process is not recommended for cooling the LEDs down from the peak temperature.
3. All temperatures refer to solder Pad.

● Hand Soldering

| | | |
|-----------------------|-----------------------|---------------|
| Soldering temperature | 300°C Max. (25W Max.) | One time only |
| Soldering time | 5 ±1sec | |

Model No.: FYLS-0603BXXXC

■ Handling of Silicone Resin LEDs-

● Handling Indications

When handling the product, do not touch it directly with bare hands as it may contaminate the surface and affect on optical characteristics. In the worst cases, excessive force to the product might result in catastrophic failure due to package damage and/or wire breakage.



When handling the product with tweezers, LEDs should only be handled from the side and make sure that excessive force is not applied to the resin portion of the product. Failure to comply can cause the resin portion of the product to be cut, chipped, delaminated and/or deformed, and wire to be broken, and thus resulting in catastrophic failure.

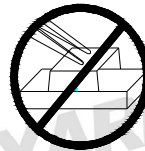
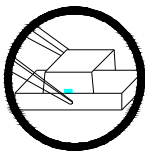

■ Recommended circuit-

• In designing a circuit, the current through each LED must not exceed the absolute maximum rating specified for each LED. It is recommended to use Circuit B which regulates the current flowing through each LED. In the meanwhile, when driving LED with a constant voltage in Circuit A, the current through the LEDs may vary due to the variation in forward voltage (VF) of the LEDs. In the worst case, some LED may be subjected to stresses in excess of the absolute maximum rating.

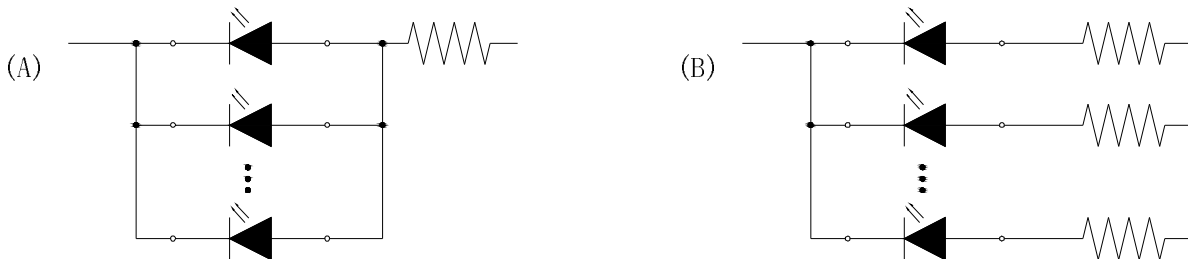

• This product should be operated in forward bias. A driving circuit must be designed so that the product is not subjected to either forward or reverse voltage while it is off. In particular, if a reverse voltage is continuously applied to the product; such operation can cause migration resulting in LED damage.

■ Storage-

● Storage Conditions

1. Unopened moisture barrier bag (MBB) shall be stored at temperature below 5°C~30°C, with humidity below 60%RH.
2. Before the MBB be opened, check if have the air leakage, if have, then need to bake at 65°C~70°C for 24hours.
3. After the MBB has been opened, the LEDs which need for reflow soldering or other soldering methods, must be used according to below:
 - a: Must finish the soldering in 72hours
 - b: Stored with the humidity below 30%RH
 - c: If not finish the soldering in 72hours, need to bake the LED again at 65°C~70°C for 24hours