

# PRODUCT SPECIFICATION

**Model No.: FYLS-1206EXXXC-RM**

Features:
<ul style="list-style-type: none"> <li>■ SMD Type</li> <li>■ Size (mm):3.20*1.60*1.10</li> <li>■ Lens Color: Water clear.</li> <li>■ Viewing Angle(2θ½):140°</li> <li>■ SMT package</li> <li>■ Suitable for all SMT assembly and soldering method</li> <li>■ Pb-free Reflow soldering application</li> <li>■ RoHS Compliant</li> <li>■ MSL:4</li> </ul>

Applications:
<ul style="list-style-type: none"> <li>■ Light Strips</li> <li>■ LCD Backlight</li> <li>■ Decorative lighting</li> <li>■ Indicators</li> <li>■ Interior automotive</li> <li>■ Illuminations</li> <li>■ Mobile Phones</li> </ul>



CUSTOMER APPROVED SIGNATURES	APPROVED BY	CHECKED BY	PREPARED BY

**NINGBO FORYARD OPTOELECTRONICS CO.,LTD.**

**Add:**No. 666 Jinghua Road, Hi-tech Park, Ningbo, Zhejiang, China

**Zip:**315103

**Tel:** 0086-574-87933652 87927870 87922206

**Fax:** 0086-574-87927917

**E-mail:**Sales@foryard.com ( General)

**Model No.: FYLS-1206EXXC-RM**

**Mechanical Dimensions**

**Positive polarity**

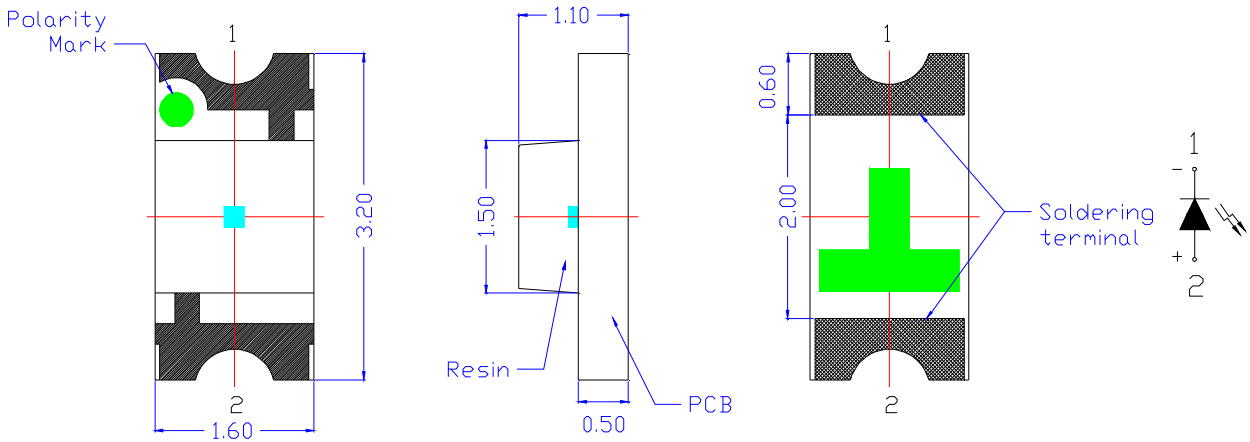

FYLS-1206EYC-RM, FYLS-1206EGC-RM, FYLS-1206EKURC-RM

FYLS-1206EKUEC-RM, FYLS-1206ESUEC-RM, FYLS-1206EUAC-RM, FYLS-1206EKUYC-RM

FYLS-1206EKUGC-RM, FYLS-1206ESUGC-RM, FYLS-1206EPGC-RM, FYLS-1206EUBC-RM

**Reverse polarity**

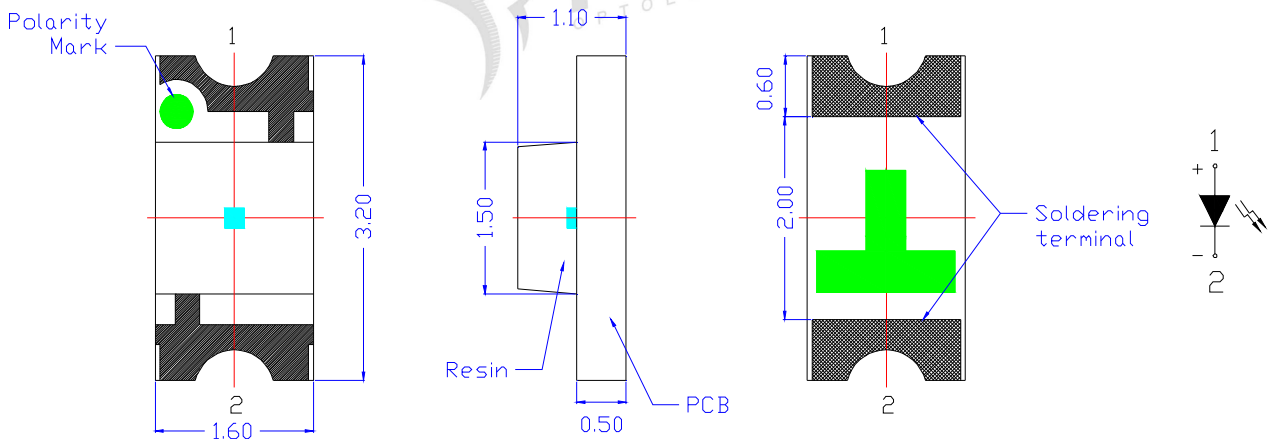

FYLS-1206ESRC-RM, FYLS-1206EHRC-RM, FYLS-1206EPURC-RM, FYLS-1206EPUAC-RM, FYLS-1206EPUYC-RM

**Recommend Soldering pad design(unit=mm)**

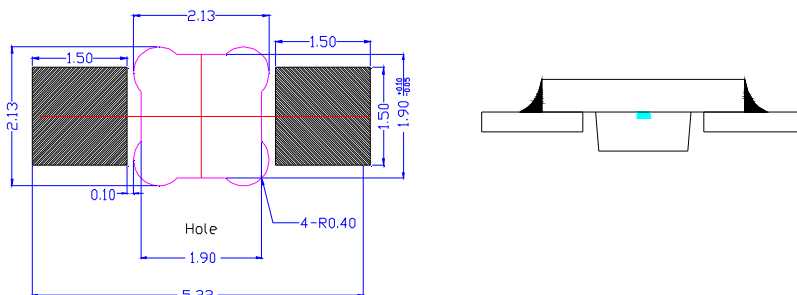

Notes:

1. Dimension in millimeter, tolerance is  $\pm 0.10$ .
2. Angle:  $\pm 5^\circ$
3. The specifications, characteristics and technical data described in the datasheet are subject to change without prior notice.
4. The drawing is different from the actual one, please refer to the sample.

**Model No.: FYLS-1206EXXC-RM**

**■ Absolute maximum ratings**

Parameter	Symbol	MAX.					Unit
		GaAsP	GaP	AlGaAs	AlGaInP	InGaN/GaN	
Power Dissipation	PD	78	80	69	78	100	mW
Peak Forward Current*	IFP	100	100	100	100	100	mA
Continuous Forward Current	IF	25	25	25	30	25	mA
Reverse Voltage	VR	5					V
Reverse Current (VR=5V)	IR	10					u A
Operating Temperature Range	Topr	-40~ +85					℃
Storage Temperature Range	Tstg	-40~ +85					℃

\*1/10 Duty Cycle, 0.1ms Pulse Width

**■ Electrical-Optical Characteristics**

**● Color Code & Chip Characteristics:(Test Condition:IF=20mA)**

(Ta=25℃)

Model No.:	Emitting Color	Dice Material	Peak Wave Length(AP) nm	Dominant Wave Length(Ad) nm			Spectral Line halfwidth (Δλ1/2) nm	Forward Voltage(VF) Unit:V			Luminous Intensity (Iv) Unit:mcd		
				Min.	Typ.	Max.		Min.	Typ.	Max.	Min.	Typ.	Max.
<b>Standard brightness</b>													
FYLS-1206ESRC-RM	Hi Red	AlGaAs	660	623	640	660	20	1.70	2.00	2.40	7.2	9	11.5
FYLS-1206EHRC-RM	Super Red	AlGaAs	660	623	640	660	20	1.70	2.00	2.40	11.5	18	22.5
FYLS-1206EYC-RM	Yellow	GaAsP	593	586	590	594	35	1.70	2.00	2.40	3.6	7.2	9.0
FYLS-1206EGC-RM	Green	GaP	570	570	572	574	10	1.70	2.00	2.40	7.2	9	14.5
<b>Ultra brightness</b>													
FYLS-1206EKURC-RM	Ultra Red	AlGaInP	645	623	632	640	20	1.70	2.00	2.40	57	72	115
FYLS-1206EPURC-RM	Ultra Red	AlGaInP	645	623	632	640	20	1.70	2.00	2.40	285	360	410
FYLS-1206EKUEC-RM	Ultra Orange	AlGaInP	625	617	622	627	35	1.70	2.00	2.40	90	145	180
FYLS-1206ESUEC-RM	Ultra Orange	AlGaInP	625	617	622	627	35	1.70	2.00	2.40	115	170	225
FYLS-1206EUAC-RM	Ultra Amber	AlGaInP	610	602	606	610	20	1.70	2.00	2.40	72	90	145
FYLS-1206EPUAC-RM	Ultra Amber	AlGaInP	610	602	606	610	20	1.70	2.00	2.40	225	285	360
FYLS-1206EKUYC-RM	Ultra Yellow	AlGaInP	593	586	590	594	20	1.70	2.00	2.40	72	90	145
FYLS-1206EPUYC-RM	Ultra Yellow	AlGaInP	593	586	590	594	20	1.70	2.00	2.20	285	360	410
FYLS-1206EKUGC-RM	Ultra Green	AlGaInP	570	570	572	574	30	1.70	2.00	2.40	22.5	30	45
FYLS-1206ESUGC-RM	Ultra Green	AlGaInP	570	570	572	574	30	1.70	2.00	2.40	36	45	72
FYLS-1206EPGC-RM	Purea Green	InGaN/GaN	520	516.5	521.5	526.5	30	2.60	3.00	3.50	550	650	850
FYLS-1206EUBC-RM	Ultra Blue	InGaN/GaN	468	463.5	470	476	30	2.60	3.00	3.50	90	120	180

**■ Material**

Item	Reflector	Wire	Encapsulate
Material	/	Gold	Epoxy

Note:

- 1.Luminous Intensity is based on the Foryard standards.
- 2.Pay attention about static for InGaN

**Model No.: FYLS-1206EXXC-RM**

■ The Luminous Intensity Grade of Products(Unit: mcd) ;Test Condition: If=20mA,Ta=25℃

A		B		C		D		E		F	
A1	A2	B1	B2	C1	C2	D1	D2	E1	E2	F1	F2
0.10	0.20	0.40	0.70	1.20	2.20	3.60	5.10	7.20	9.00	11.50	14.50
0.20	0.40	0.70	1.20	2.20	3.60	5.10	7.20	9.00	11.50	14.50	18.00
G		H		J		K		L		M	
G1	G2	H1	H2	J1	J2	K1	K2	L1	L2	M1	M2
18.00	22.50	28.50	36.00	45.00	57.00	72.00	90.00	115.00	145.00	180.00	225.00
22.50	28.50	36.00	45.00	57.00	72.00	90.00	115.00	145.00	180.00	225.00	285.00
N		P		Q		R		SA		SB	
N1	N2	P1	P2	Q1	Q2	R1	R2	S1	S2	S3	S4
285.00	360.00	450.00	550.00	650.00	750.00	850.00	950.00	1050.00	1150.00	1250.00	1350.00
360.00	450.00	550.00	650.00	750.00	850.00	950.00	1050.00	1150.00	1250.00	1350.00	1450.00
SC		TA		TB		TC		UA		UB	
S5	S6	T1	T2	T3	T4	T5	T6	U1	U2	U3	U4
1450.00	1550.00	1650.00	1750.00	1850.00	1950.00	2050.00	2250.00	2450.00	2650.00	2850.00	3050.00
1550.00	1650.00	1750.00	1850.00	1950.00	2050.00	2250.00	2450.00	2650.00	2850.00	3050.00	3350.00
UC		VA		VB		VC		WA		WB	
U5	U6	V1	V2	V3	V4	V5	V6	W1	W2	W3	W4
3350.00	3650.00	3950.00	4250.00	4650.00	5050.00	5550.00	6050.00	6650.00	7250.00	7950.00	8650.00
3650.00	3950.00	4250.00	4650.00	5050.00	5550.00	6050.00	6650.00	7250.00	7950.00	8650.00	9450.00
WC		XA		XB		XC					
W5	W6	X1	X2	X3	X4	X5	X6				
9450.00	10250.00	11250.00	13250.00	16250.00	19250.00	23250.00	27250.00				
10250.00	11250.00	13250.00	16250.00	19250.00	23250.00	27250.00	32250.00				
10250.00	11250.00										

Tolerance of measurement of luminous intensity is ±15%

■ Forward Voltage Grade of Products (Unit: V); Test Condition: If=20mA,Ta=25℃

1	2	3	4	5	6	7	8	9	10	11	12
1.40	1.50	1.60	1.70	1.80	1.90	2.00	2.10	2.20	2.30	2.40	2.50
1.50	1.60	1.70	1.80	1.90	2.00	2.10	2.20	2.30	2.40	2.50	2.60
13	14	15	16	17	18	19	20	21	22	23	24
2.60	2.70	2.80	2.90	3.00	3.10	3.20	3.30	3.40	3.50	3.60	3.70
2.70	2.80	2.90	3.00	3.10	3.20	3.30	3.40	3.50	3.60	3.70	3.80

Tolerance of measurement of forward voltage is ±0.1V

**Model No.: FYLS-1206EXXC-RM**

■ Dominate Wavelength Grade of Products (Unit: nm); Test Condition: If=20mA, Ta=25°C

Red/Ultra Red			
UR			
0	1	2	3
620.00	623.00	627.00	632.00
623.00	627.00	632.00	640.00

Red	
SR/HR	
1	2
632.00	640.00
640.00	660.00

Orange/Ultra Orange			
E/UE			
1	2	3	4
614.00	618.00	622.00	627.00
618.00	622.00	627.00	632.00

Amber/Ultra Amber			
A/UA			
1	2	3	4
598.00	602.00	606.00	610.00
602.00	606.00	610.00	614.00

Yellow /Ultra Yellow					
Y/UY					
1	2	3	4	5	6
584.00	586.00	588.00	590.00	592.00	594.00
586.00	588.00	590.00	592.00	594.00	596.00

Yellow Green/Ultra Yellow Green				
G/UG				
0	1	2	3	4
568.00	570.00	572.00	574.00	576.00
570.00	572.00	574.00	576.00	578.00

Purea Green									
PG									
1	2	3	4	5	6	7	8	9	A
511.50	514.00	516.50	519.00	521.50	524.00	526.50	529.00	531.50	534.00
514.00	516.50	519.00	521.50	524.00	526.50	529.00	531.50	534.00	536.50

Ultra Blue					
UB					
0	1	2	3	4	5
460.00	463.50	466.00	468.50	471.00	473.50
463.50	466.00	468.50	471.00	473.50	476.00



Tolerance for each Dominate Wavelength bin is ±1nm

**Model No.: FYLS-1206EXXC-RM**

**Electrical-Optical Characteristics-**

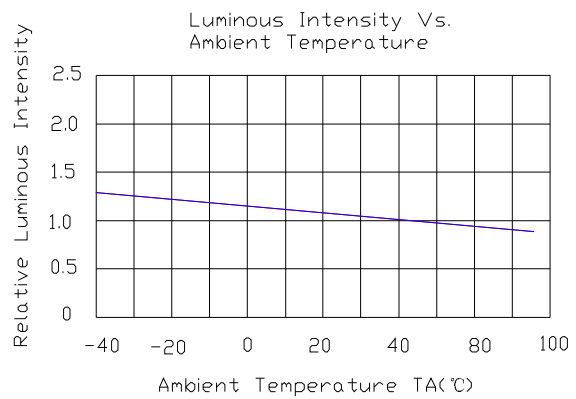
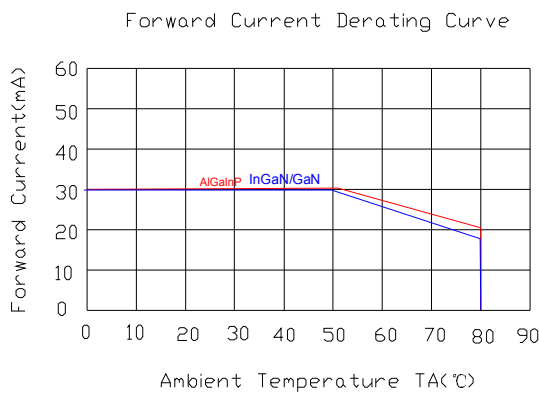
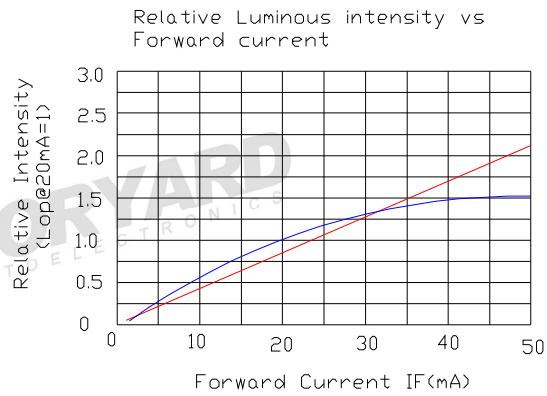
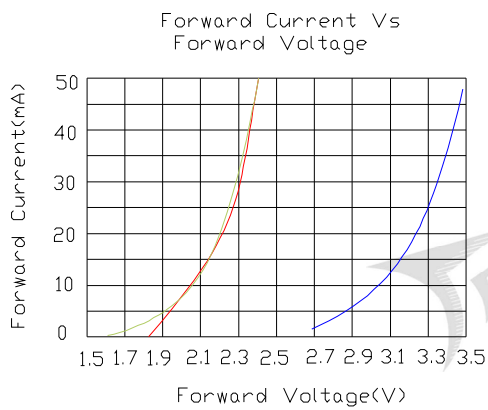
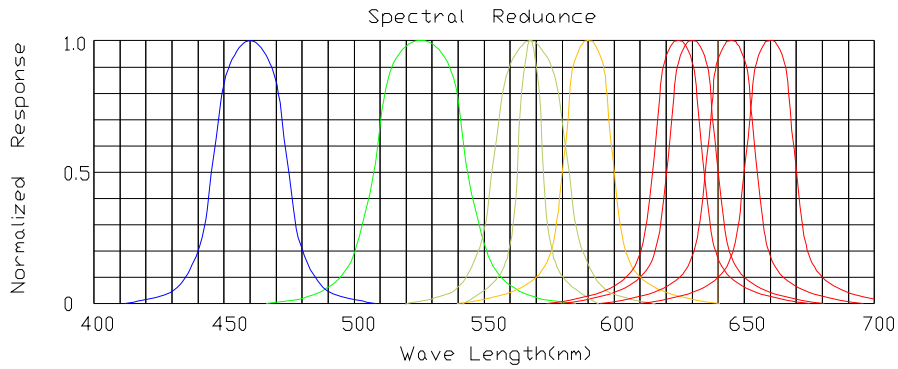

**NOTE: 25°C free air temperature unless otherwise specified**

**Radiation pattern-**

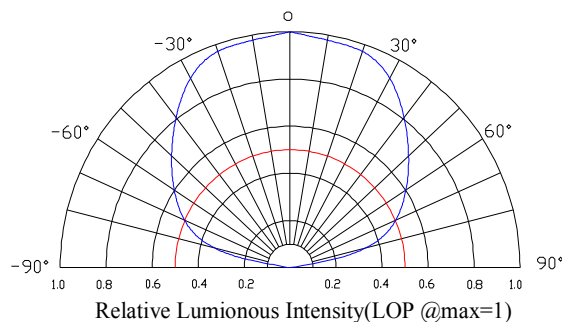

**Model No.: FYLS-1206EXXC-RM**

■ **Package-**

1. Reel Dimension

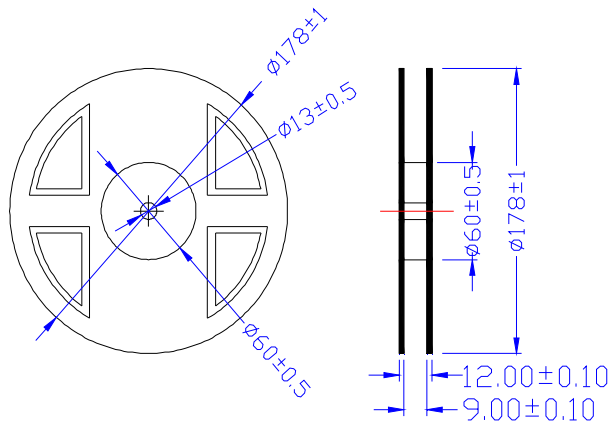

2. Tape Dimension

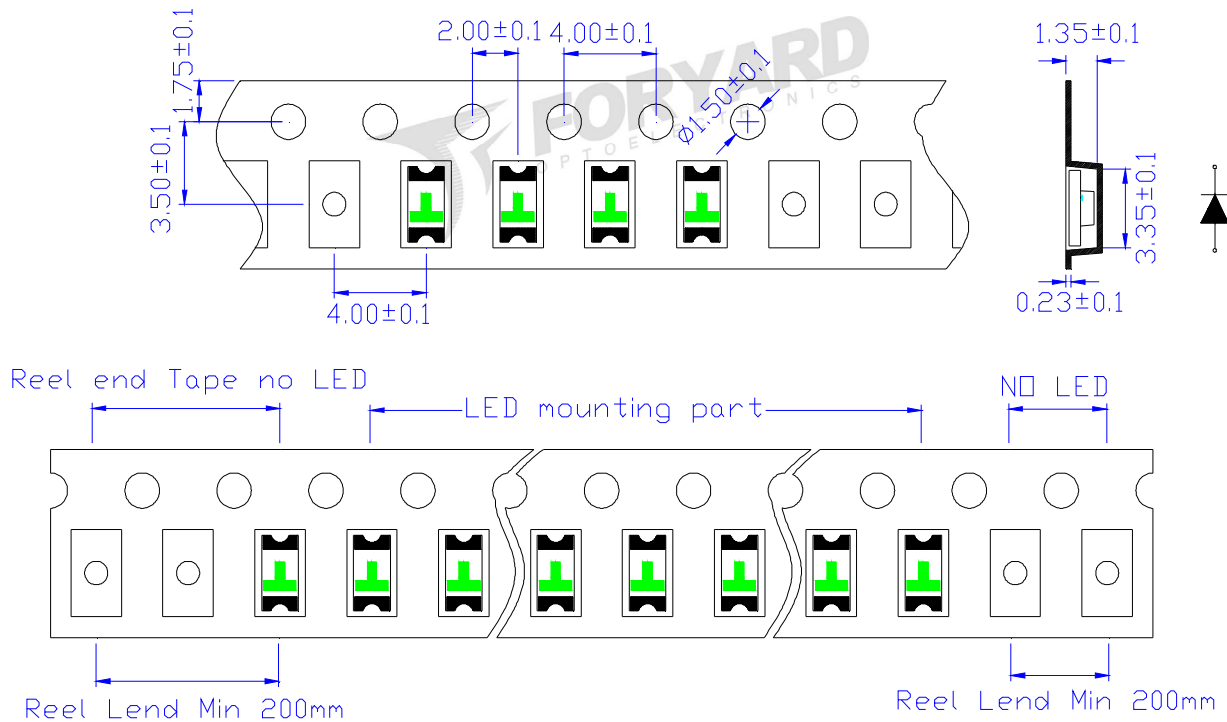

FYLS-1206EYC-RM, FYLS-1206EGC-RM, FYLS-1206EKURC-RM

FYLS-1206EKUEC-RM, FYLS-1206ESUEC-RM, FYLS-1206EUAC-RM, FYLS-1206EKUYC-RM

FYLS-1206EKUGC-RM, FYLS-1206ESUGC-RM, FYLS-1206EPGC-RM, FYLS-1206EUBC-RM

Notice:

1. Tolerance unless mentioned is  $\pm 0.2\text{mm}$

**Model No.: FYLS-1206EXXXC-RM**

■ Package-

1. Reel Dimension

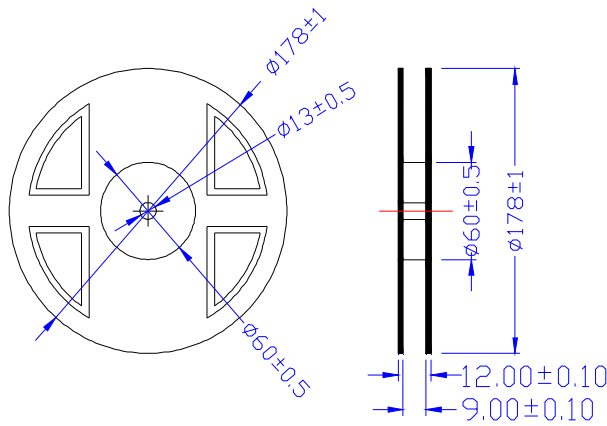

2. Tape Dimension

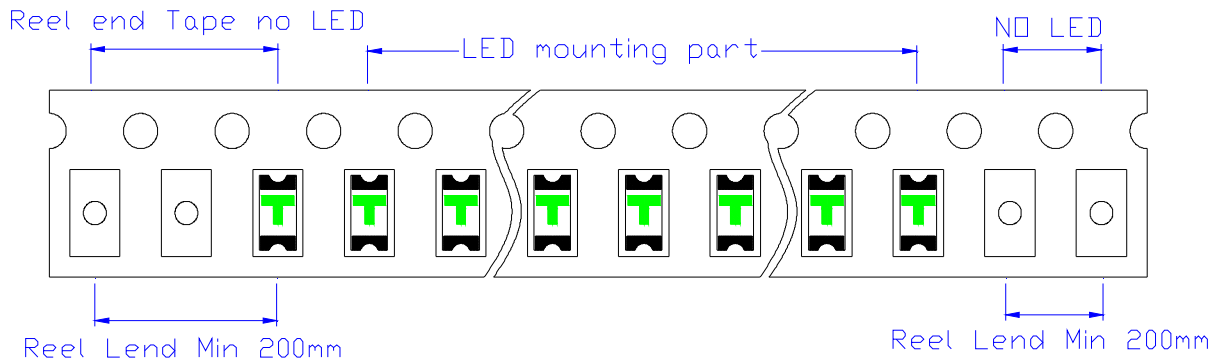
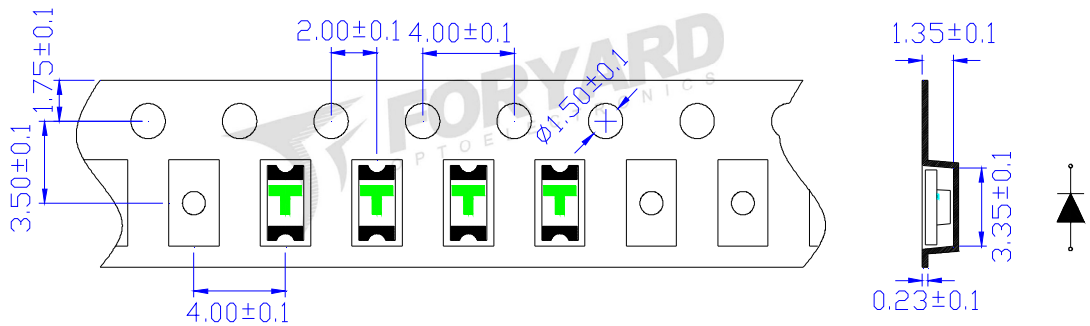

FYLS-1206ESRC-RM, FYLS-1206EHRC-RM, FYLS-1206EPURC-RM, FYLS-1206EPUAC-RM, FYLS-1206EPUYC-RM

Notice:



1. Tolerance unless mentioned is  $\pm 0.2\text{mm}$



Model No.:	FYLS-1206EXXC-RM
Date / Rev.	2023.02.24 / C

**Model No.: FYLS-1206EXXC-RM**

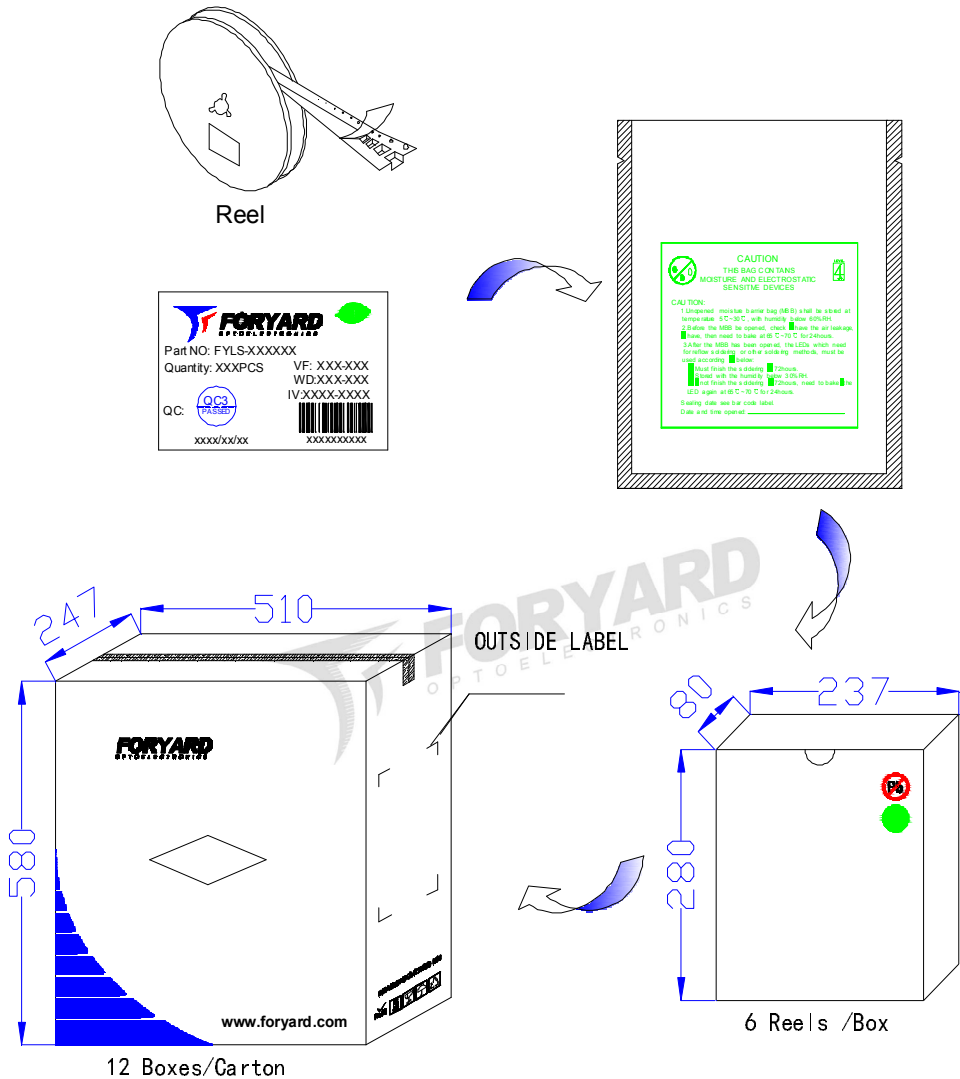
3. Packing Diagram

**LED**

PN: FYLS-XXXXXXXXXX

Qty: XXXXX PCS

Date: XXXX/XX/XX

GW: XX.XX KG

NW: XX.XX KG

XXXXXXXXXX

RoHS

ATTENTION

OUTSIDE LABEL

Notice:

- 1.Quantity:3000 PCS/Reel
- 2.The specifications are subject to change without notice. Please contact us for updated information.

**Model No.: FYLS-1206EXXC-RM**

**■ Soldering Characteristics-**

**● Reflow Soldering**

**● Lead Solder**

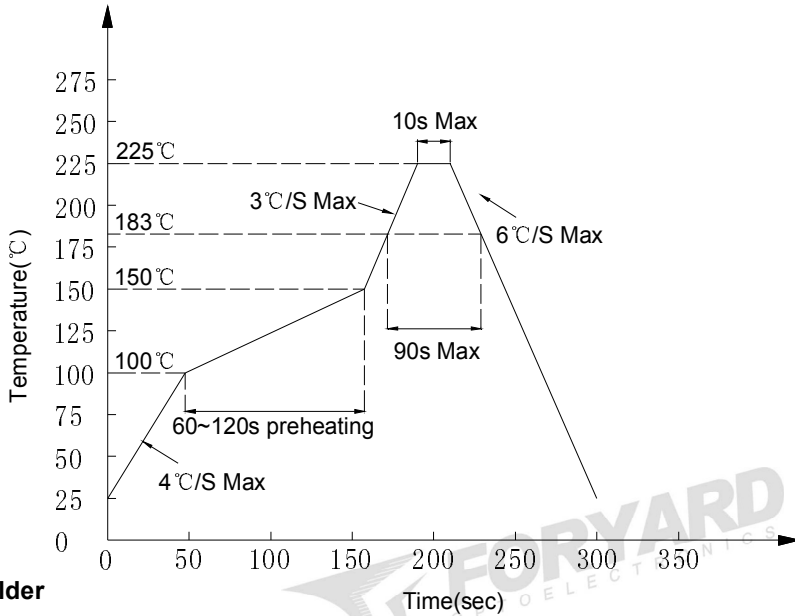

**● Lead-free Solder**

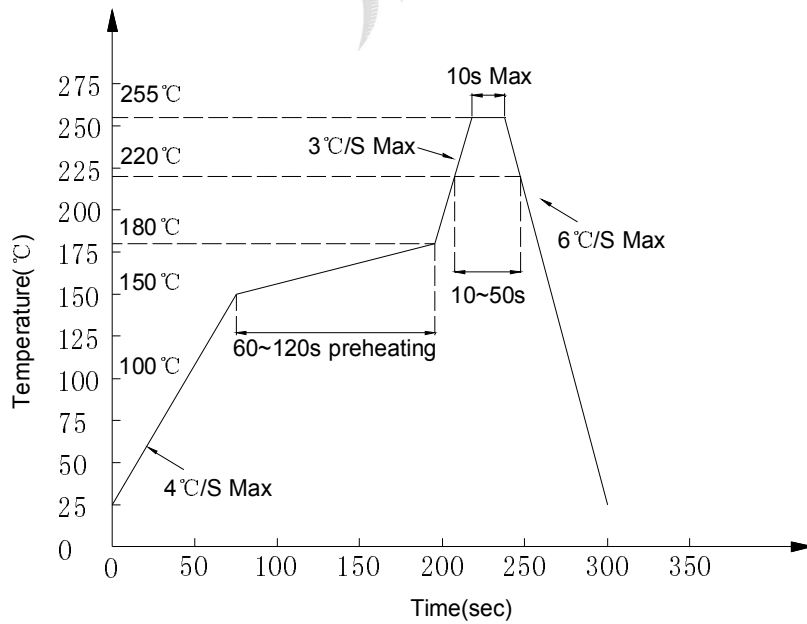

**Notes:**

1. Although the recommended soldering conditions are specified in above table, reflow or hand soldering at the lowest possible temperature is desired for the LEDs.
2. A rapid-rate process is not recommended for cooling the LEDs down from the peak temperature.
3. All temperatures refer to solder Pad.

**● Hand Soldering**

Soldering temperature	300°C Max. (25W Max.)	One time only
Soldering time	5 ±1sec	

**Model No.: FYLS-1206EXXC-RM**

**■ Handling of Silicone Resin LEDs-**

**● Handling Indications**

When handling the product, do not touch it directly with bare hands as it may contaminate the surface and affect on optical characteristics. In the worst cases, excessive force to the product might result in catastrophic failure due to package damage and/or wire breakage.



When handling the product with tweezers, LEDs should only be handled from the side and make sure that excessive force is not applied to the resin portion of the product. Failure to comply can cause the resin portion of the product to be cut, chipped, delaminated and/or deformed, and wire to be broken, and thus resulting in catastrophic failure.

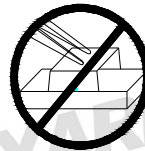
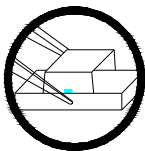

**■ Recommended circuit-**

• In designing a circuit, the current through each LED must not exceed the absolute maximum rating specified for each LED. It is recommended to use Circuit B which regulates the current flowing through each LED. In the meanwhile, when driving LED with a constant voltage in Circuit A, the current through the LEDs may vary due to the variation in forward voltage (VF) of the LEDs. In the worst case, some LED may be subjected to stresses in excess of the absolute maximum rating.

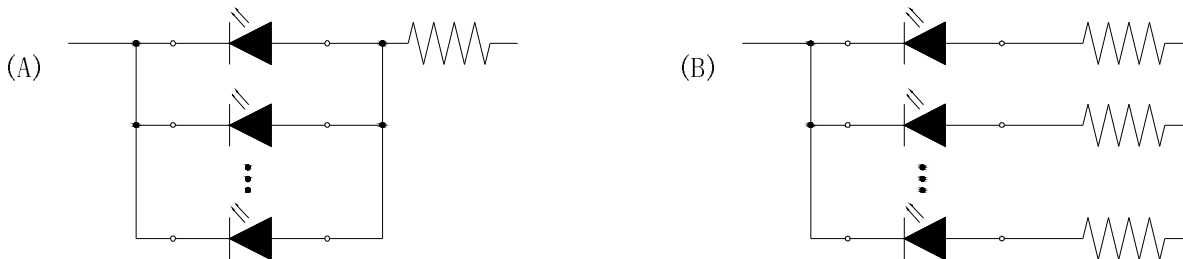

• This product should be operated in forward bias. A driving circuit must be designed so that the product is not subjected to either forward or reverse voltage while it is off. In particular, if a reverse voltage is continuously applied to the product; such operation can cause migration resulting in LED damage.

**■ Storage-**

**● Storage Conditions**

1. Unopened moisture barrier bag (MBB) shall be stored at temperature below 5°C~30°C, with humidity below 60%RH.
2. Before the MBB be opened, check if have the air leakage, if have, then need to bake at 65°C~70°C for 24hours.
3. After the MBB has been opened, the LEDs which need for reflow soldering or other soldering methods, must be used according to below:
  - a: Must finish the soldering in 72hours
  - b: Stored with the humidity below 30%RH
  - c: If not finish the soldering in 72hours, need to bake the LED again at 65°C~70°C for 24hours