

PRODUCT SPECIFICATION

Model No.: FYLS-3014UWCXX-0.2W

Features:
<ul style="list-style-type: none"> ■ SMD Type ■ Size (mm):3.00*1.40*0.70 ■ Emitting Color: White. ■ Lens Color: Yellow Diffused. ■ SMT package ■ Suitable for all SMT assembly and soldering method ■ Pb-free Reflow soldering application ■ RoHS Compliant ■ MSL:6

Applications:
<ul style="list-style-type: none"> ■ Light Strips ■ LCD Backlight ■ Decorative lighting ■ Indicators ■ Interior automotive ■ Illuminations ■ Mobile Phones



CUSTOMER APPROVED SIGNATURES	APPROVED BY	CHECKED BY	PREPARED BY

NINGBO FORYARD OPTOELECTRONICS CO.,LTD.

Add:No. 666 Jinghua Road, Hi-tech Park, Ningbo, Zhejiang, China

Zip:315103

Tel: 0086-574-87933652 87927870 87922206

Fax: 0086-574-87927917

E-mail:Sales@foryard.com (General)

Model No.: FYLS-3014UWCXX-0.2W

■ Mechanical Dimensions

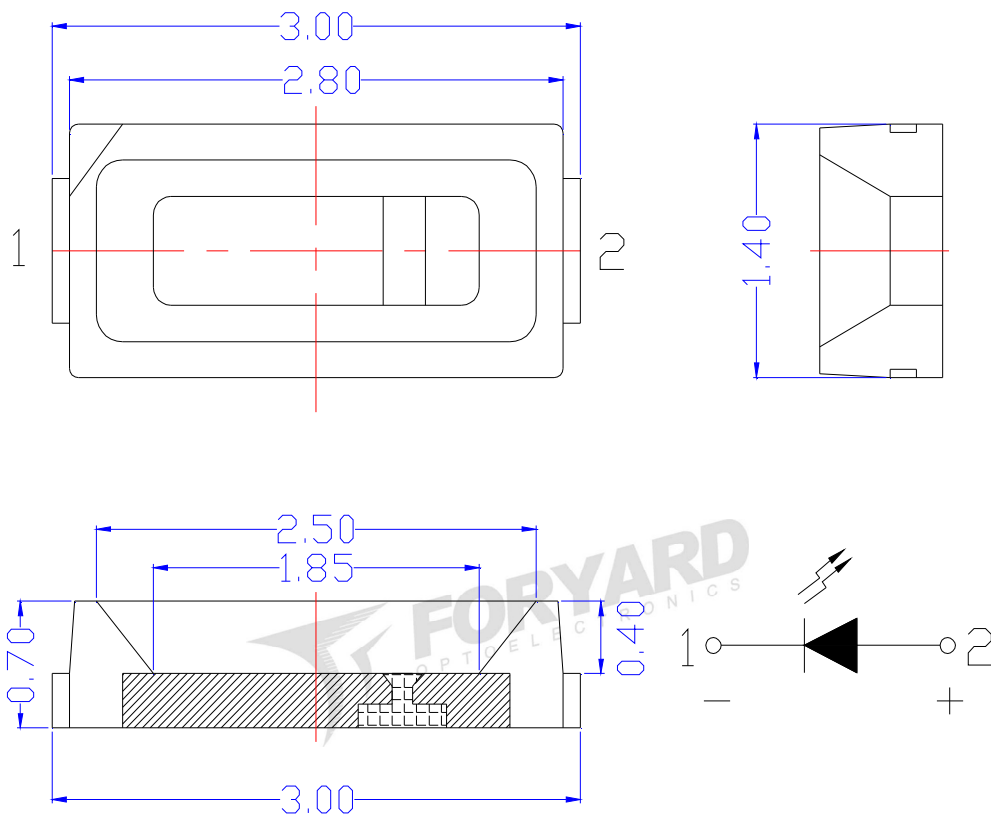

■ Recommend Soldering pad design(unit=mm)

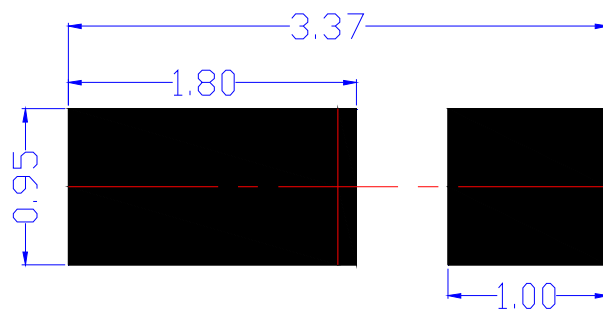

Notes:

1. Dimension in millimeter, tolerance is ± 0.10 .
2. Angle: $\pm 5^\circ$
3. The specifications, characteristics and technical data described in the datasheet are subject to change without prior notice.
4. The drawing is different from the actual one, please refer to the sample.

Model No.: FYLS-3014UWCXX-0.2W

Absolute Maximum Ratings(Ta=25°C)

Parameter	Symbol	MAX.	Unit
Power Dissipation	PD	200	mW
Peak Forward Current*	IFP	60	mA
Continuous Forward Current	IF	60	mA
Reverse Voltage	VR	5	V
Operating Temperature Range	Topr	-40~ +85	°C
Storage Temperature Range	Tstg	-40~ +85	°C

*1/10 Duty Cycle, 0.1ms Pulse Width

Typical Electrical & Optical Characteristics(Ta=25°C)

Parameter	Symbol	Test Condition	Min.	Typ.	Max.	Unit
Forward Voltage	V _F	IF=60mA	2.6	3	3.4	V
Reverse Current	I _R	VR=5V	---	---	10	μA
Chromaticity coordinates	X	IF=60mA	---	0.38	---	---
	Y	IF=60mA	---	0.38	---	---
Color temperature	CCT	IF=60mA	2850	4000	7200	K
Luminous Flux	Φ	IF=60mA	24	28	---	Lm
Color Rendering Index	Ra	IF=60mA	---	80	---	---
Viewing Angle	2θ _{1/2}	IF=60mA	---	120	---	Deg

Material

Item	Reflector	Wire	Encapsulate	Chip
Material	PPA	Gold	Silicone	InGaN/GaN

Note:

- 1.Luminous Intensity is based on the Foryard standards.
- 2.Pay attention about static for InGaN

The Luminous Intensity Grade of Products(Unit: Lm) ;Test Condition: IF=60mA,Ta=25°C

Code	B20	B21	B22
Luminous Flux (Lm)	24~26	26~28	28~30

Tolerance of measurement of luminous intensity is ±15%

Forward Voltage Grade of Products (Unit: V); Test Condition: IF=60mA,Ta=25°C

Code	6	7	8	9
Forward Voltage(V)	2.6~2.8	2.8~3.0	3.0~3.2	3.2~3.4

Tolerance of measurement of forward voltage is ±0.1V

Model No.:	Color temperature (CCT) Unit:K			Luminous Flux (Iv) Unit:Lm		
	Min.	Typ.	Max.	Min.	Typ.	Max.
FYLS-3014UWC65-0.2W	6150	6610	7150	26	28	---
FYLS-3014UWC50-0.2W	4950	5200	5550	26	28	---
FYLS-3014UWC40-0.2W	3900	4116	4400	26	28	---
FYLS-3014UWC30-0.2W	2850	2977	3150	24	26	---

Model No.: FYLS-3014UWCXX-0.2W

■ Chromaticity Coordinate Grade of White Chip-LED Products

Test Condition: @IF=60mA Ta=25°C

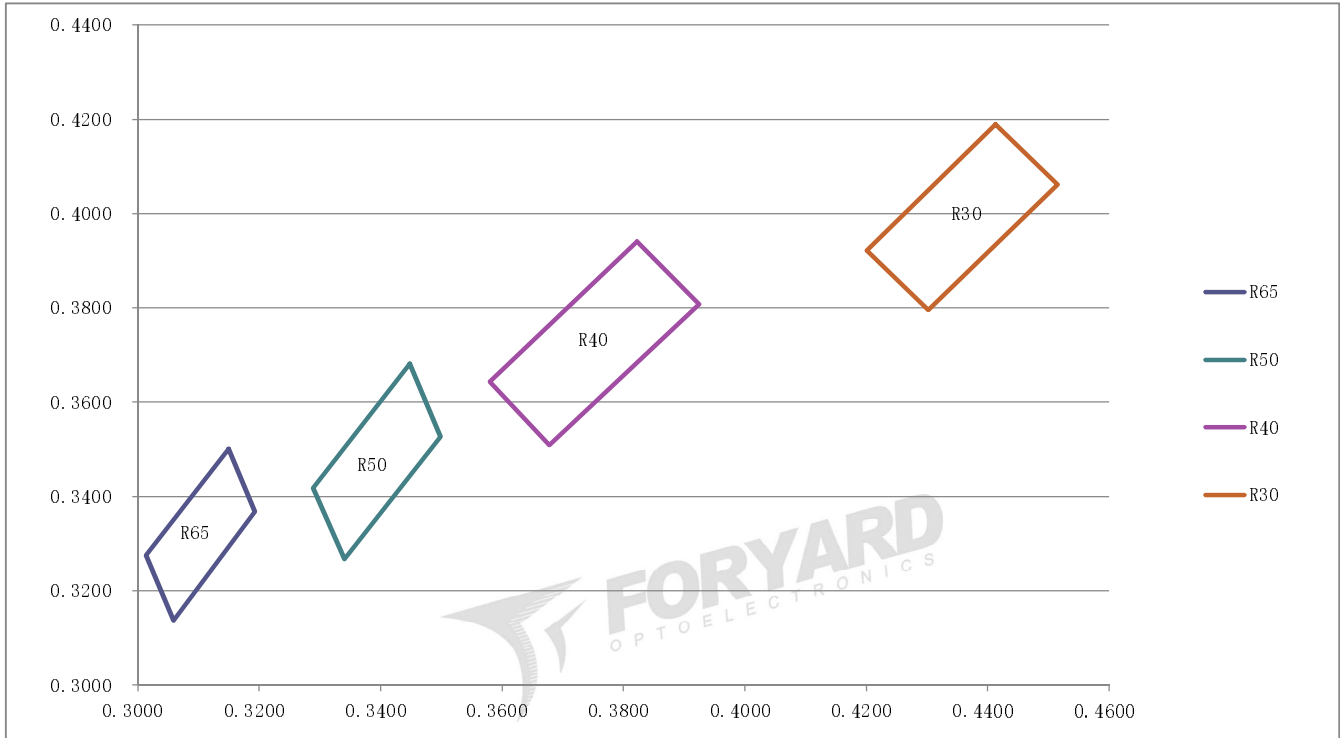

BIN	CIE	Top	Right	Bottom	Left
6500K					
R65	X	0.3149	0.3013	0.3059	0.3193
	Y	0.3501	0.3276	0.3137	0.3368
5000K					
R50	X	0.3448	0.3289	0.3340	0.3498
	Y	0.3682	0.3418	0.3268	0.3527
4000K					
R40	X	0.3822	0.3580	0.3678	0.3925
	Y	0.3941	0.3643	0.3509	0.3808
3000K					
R30	X	0.4413	0.4201	0.4302	0.4515
	Y	0.4189	0.3922	0.3796	0.4061

Model No.: FYLS-3014UWCXX-0.2W

Electrical-Optical Characteristics-

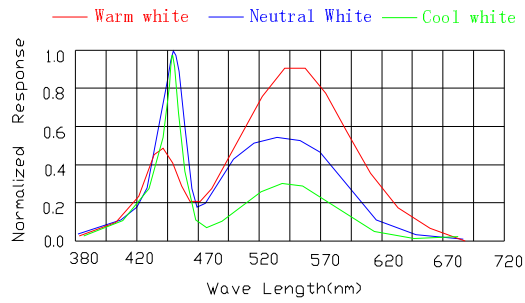

Soldering Temperature VS. Forward Current

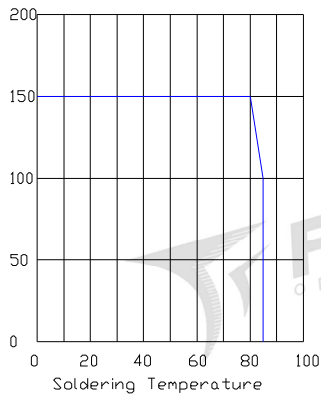

Forward Current VS. Relative Intensity

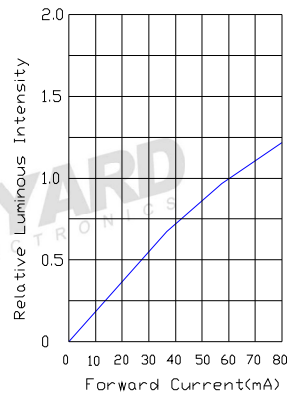

Forward Current vs. Forward Voltage

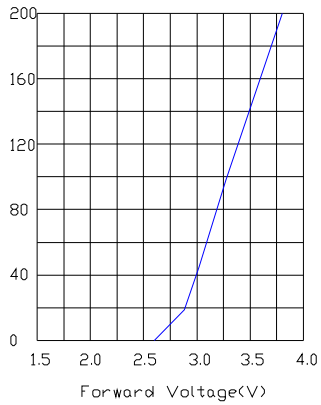

Ambient Temperature vs. Relative Intensity

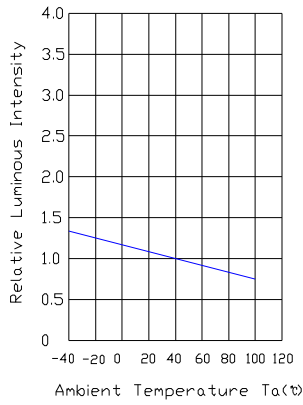

NOTE: 25°C free air temperature unless otherwise specified

Radiation pattern-

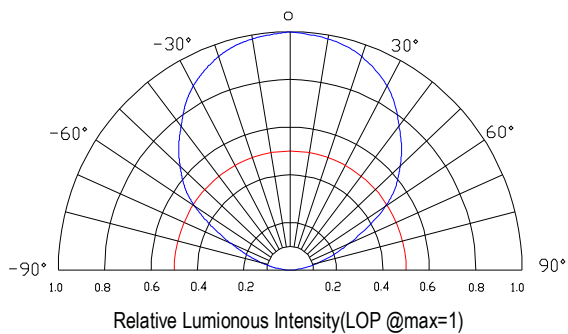

Model No.: FYLS-3014UWCXX-0.2W

■ **Package-**

1. Reel Dimension

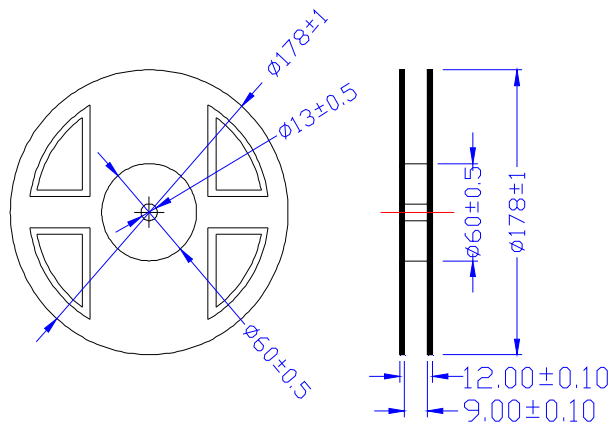

2. Tape Dimension

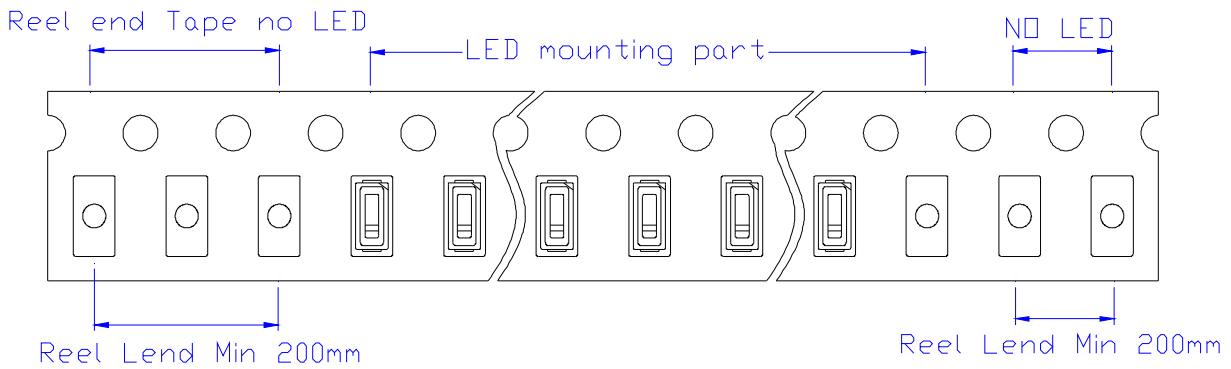
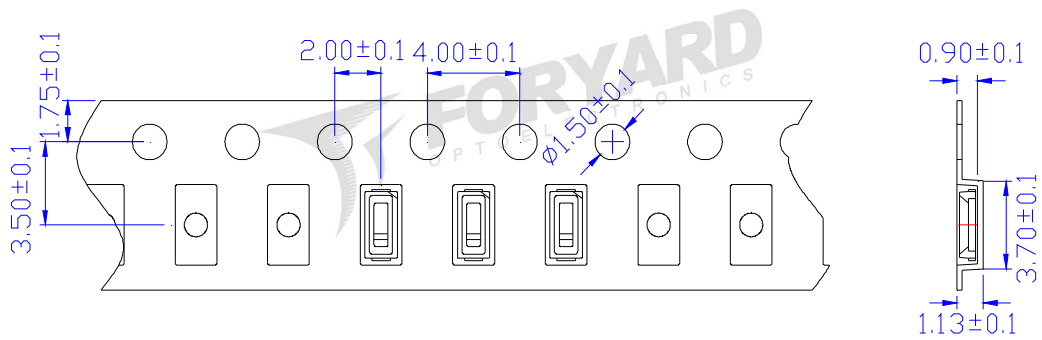



Notice:

1. Tolerance unless mentioned is $\pm 0.2\text{mm}$

Model No.:	FYLS-3014UWCXX-0.2W
Date / Rev.	2021.02.21 / B

Model No.: FYLS-3014UWCXX-0.2W

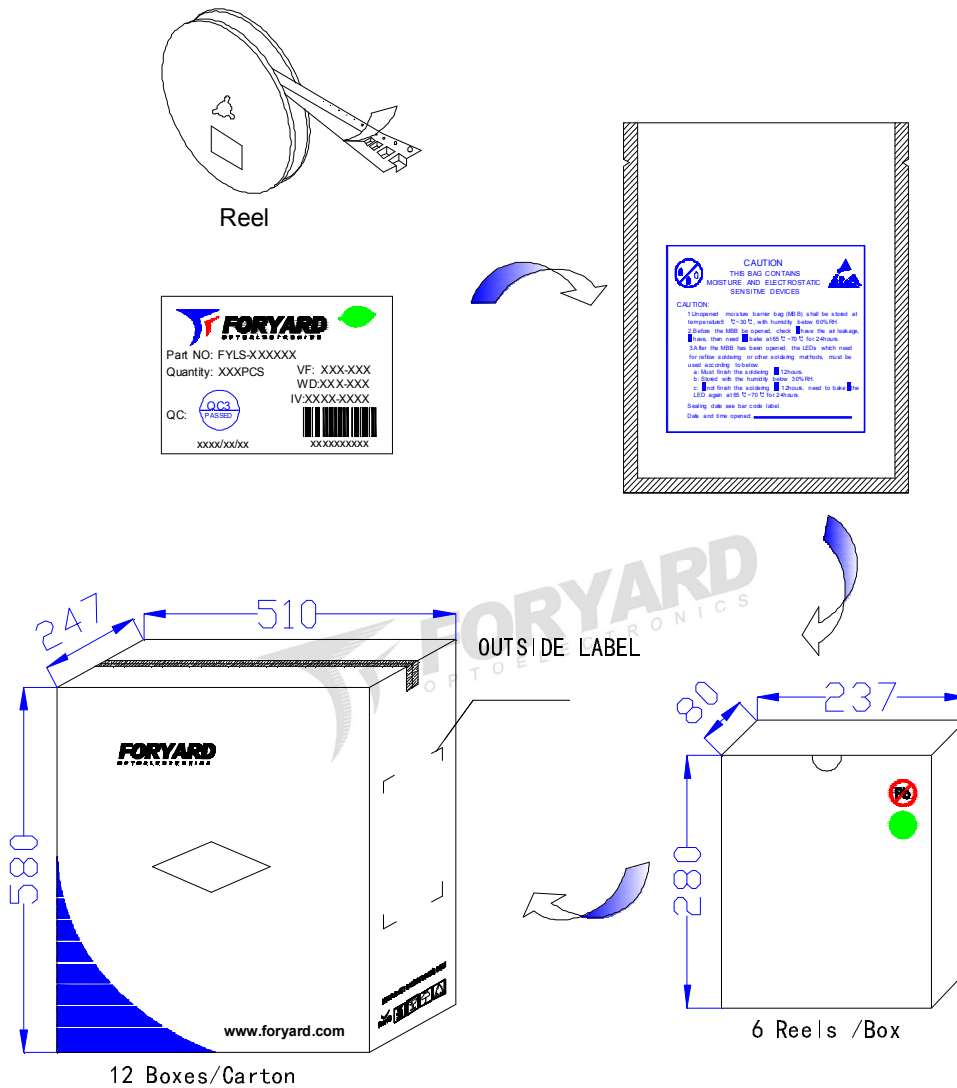

3. Packing Diagram

LED
PN: FYLS-XXXXXXXXXX
Qty: XXXXX PCS
Date: XXXX/XX/XX
GW: XX.XX KG
NW: XX.XX KG



XXXXXXXXXX

OUTSIDE LABEL

Notice:

- 1.Quantity:4000 PCS/Reel
- 2.The specifications are subject to change without notice. Please contact us for updated information.

Model No.: FYLS-3014UWCXX-0.2W

■ Soldering Characteristics-

● Reflow Soldering

● Lead Solder

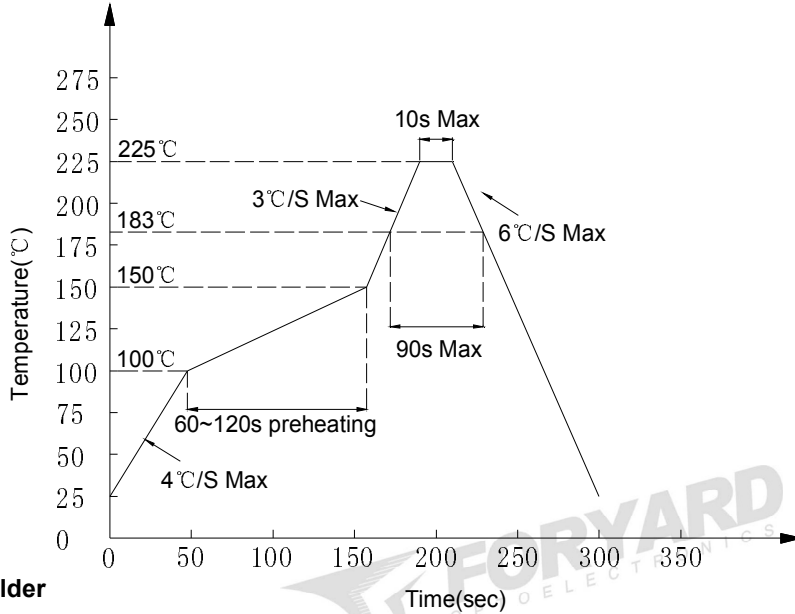

● Lead-free Solder

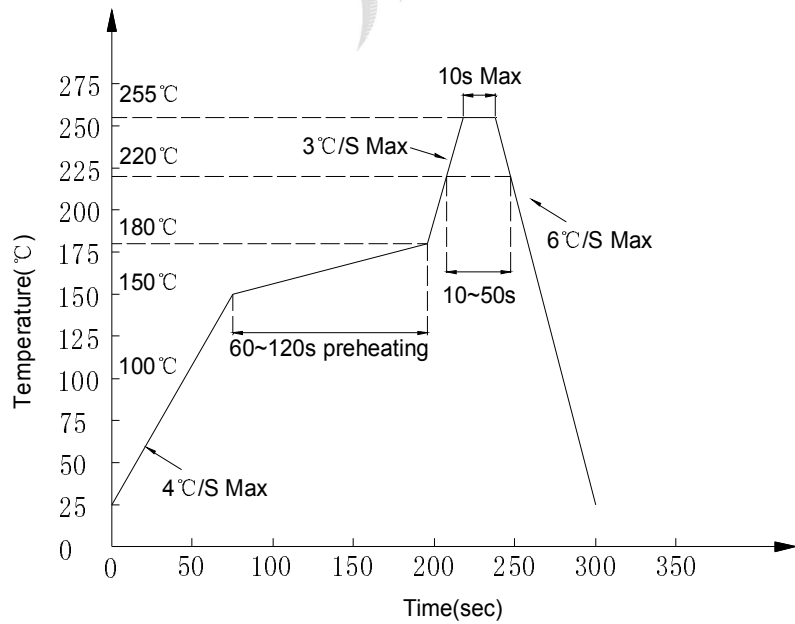

Notes:

1. Although the recommended soldering conditions are specified in above table, reflow or hand soldering at the lowest possible temperature is desired for the LEDs.
2. A rapid-rate process is not recommended for cooling the LEDs down from the peak temperature.
3. All temperatures refer to solder Pad.

● Hand Soldering

Soldering temperature	300°C Max. (25W Max.)	One time only
Soldering time	5 ±1sec	

Model No.: FYLS-3014UWCXX-0.2W

■ **Handling of Silicone Resin LEDs-**

● **Handling Indications**

When handling the product, do not touch it directly with bare hands as it may contaminate the surface and affect on optical characteristics. In the worst cases, excessive force to the product might result in catastrophic failure due to package damage and/or wire breakage.

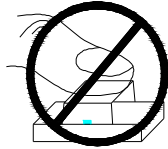

When handling the product with tweezers, LEDs should only be handled from the side and make sure that excessive force is not applied to the resin portion of the product. Failure to comply can cause the resin portion of the product to be cut, chipped, delaminated and/or deformed, and wire to be broken, and thus resulting in catastrophic failure.

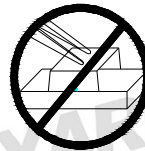
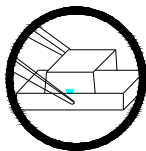

■ **Recommended circuit-**

• In designing a circuit, the current through each LED must not exceed the absolute maximum rating specified for each LED. It is recommended to use Circuit B which regulates the current flowing through each LED. In the meanwhile, when driving LED with a constant voltage in Circuit A, the current through the LEDs may vary due to the variation in forward voltage (VF) of the LEDs. In the worst case, some LED may be subjected to stresses in excess of the absolute maximum rating.

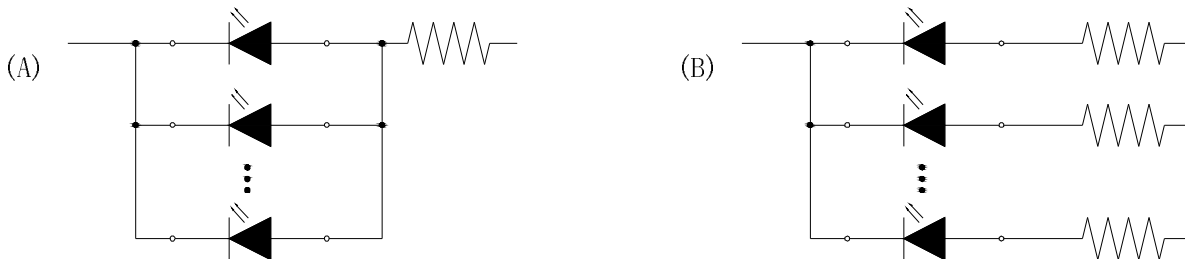

• This product should be operated in forward bias. A driving circuit must be designed so that the product is not subjected to either forward or reverse voltage while it is off. In particular, if a reverse voltage is continuously applied to the product; such operation can cause migration resulting in LED damage.

■ **Storage-**

● **Storage Conditions**

1. Unopened moisture barrier bag (MBB) shall be stored at temperature below 5°C~30°C, with humidity below 60%RH.
2. Before the MBB be opened, check if have the air leakage, if have, then need to bake at 70°C±5°C for 24hours.
3. After the MBB has been opened, the LEDs which need for reflow soldering or other soldering methods, must be used according to below:
 - a: Must finish the soldering in 12hours
 - b: Stored with the humidity below 30%RH
 - c: If not finish the soldering in 12hours, need to bake the LED again at 70°C±5°C for 24hours