

# PRODUCT SPECIFICATION

**Model No.: FYLF-1130PUR1C**

Descriptions:	
<ul style="list-style-type: none"> <li>■ Flux LED Type.</li> <li>■ Size (mm):Φ5*7.62*7.62.</li> <li>■ Emitting Color: Super Bright Red.</li> <li>■ Lens Type: Water clear.</li> <li>■ Pb-free Reflow soldering application.</li> <li>■ RoHS Compliant.</li> </ul>	

Applications:
<ul style="list-style-type: none"> <li>■ Indicators.</li> <li>■ Automotive application.</li> <li>■ Decorative lighting.</li> <li>■ Illuminations</li> </ul>



CUSTOMER APPROVED SIGNATURES	APPROVED BY	CHECKED BY	PREPARED BY

**NINGBO FORYARD OPTOELECTRONICS CO.,LTD.**

**Add:**No. 666 Jinghua Road, Hi-tech Park, Ningbo, Zhejiang, China

**Zip:**315103

**Tel:** 0086-574-87933652 87927870

**Fax:** 0086-574-87927917

**E-mail:**Sales@foryard.com (General)

**Model No.: FYLF-1130PUR1C**

**Mechanical Dimensions**

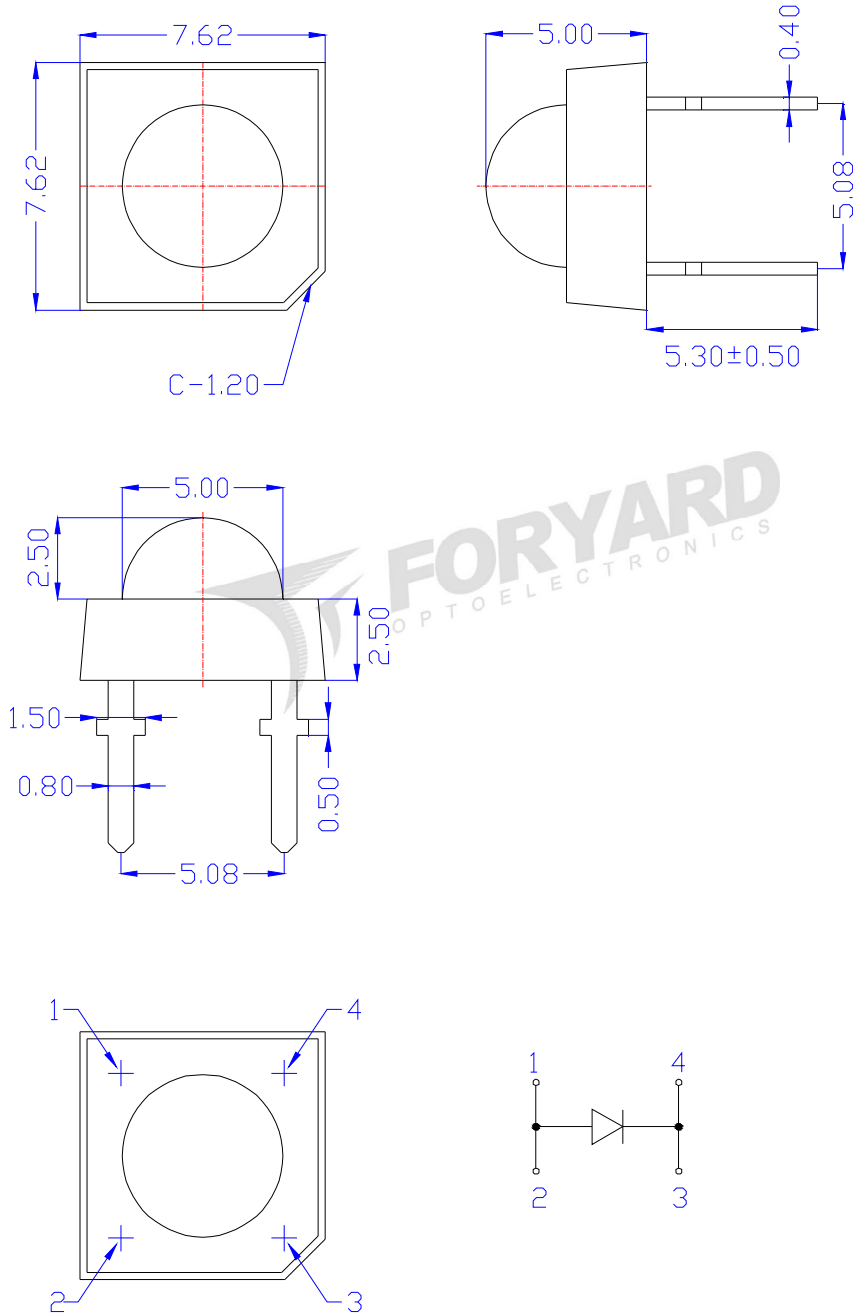

**Notes:**

1. All dimensions are millimeters (inches)
2. Tolerance is  $\pm 0.25\text{mm}$  (.010") unless otherwise noted.
3. The specifications, characteristics and technical data described in the datasheet are subject to change without prior notice.
4. The drawing is different from the actual one, please refer to the sample.

**Model No.: FYLF-1130PUR1C**

**Absolute Maximum Ratings(Ta=25°C)**

Parameter	Symbol	MAX.	Unit
Forward Current(DC)	IF	30	mA
Peak Forward Current *	IFP	100	mA
Power Dissipation	PD	130	mW
Reverse Voltage	VR	5	V
Operating Temperature Range	Topr	-30°C to +85°C	
Storage Temperature Range	Tstg	-30°C to +100°C	
Soldering Temperature	Tsol	Reflow Soldering:260°C/3sec	

\*Pulse width  $\leq$  1msec duty  $\leq$  1/10

**Typical Electrical & Optical Characteristics(Ta=25°C)**

Parameter	Symbol	Min.	Typ.	Max.	Unit	Test Condition
Luminous Intensity	$I_V$	810	1135	2225	mcd	IF=20mA
Viewing Angle	$2\theta_{1/2}$	---	90	---	Deg	
Peak Emission Wavelength	$\lambda_p$	---	630	--	nm	
Dominant Wavelength	$\lambda_d$	620	625	630	nm	
Spectral Line Half-Width	$\Delta\lambda$	---	20	--	nm	
Forward Voltage	$V_F$	1.60	2.00	2.40	V	VR=5V
Reverse Current	$I_R$	---	---	10	$\mu$ A	

**Material**

Item	Reflector	Wire	Encapsulate	Chip
Material	Iron	Gold	Epoxy	AlGaInP

Note:

- 1.Luminous Intensity is based on the Foryard standards.
- 2.Pay attention about static for InGaN

**Luminous Intensity Guide (Unit: mcd) @IF=20mA**

Code	L16	L17	L18
Luminous Intensity(mcd)	810~1135	1135~1590	1590~2225

Tolerance of measurement of luminous intensity is  $\pm$ 15%

**Dominate Wavelength Guide (Unit: nm) @IF=20mA**

Code	R2	R3
Dominate Wavelength(nm)	620~625	625~630

Tolerance for each Dominate Wavelength bin is  $\pm$ 1nm

**Forward Voltage Guide (Unit: V) @IF=20mA**

Code	V2	V3	V4	V5
Forward Voltage(V)	1.6~1.8	1.8~2.0	2.0~2.2	2.2~2.4

Tolerance of measurement of forward voltage is  $\pm$ 0.1V

**Model No.: FYLF-1130PUR1C**

**Typical Electrical/Optical Characteristics Curves(Ta=25°C Unless Otherwise Noted)**

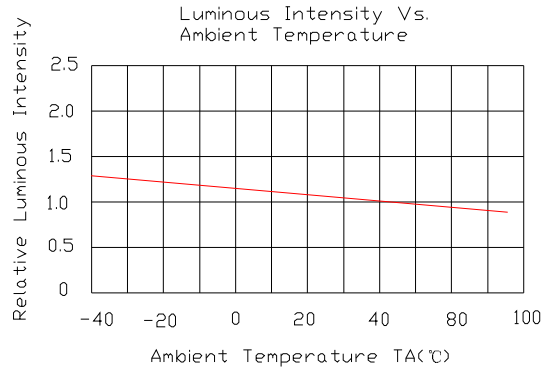
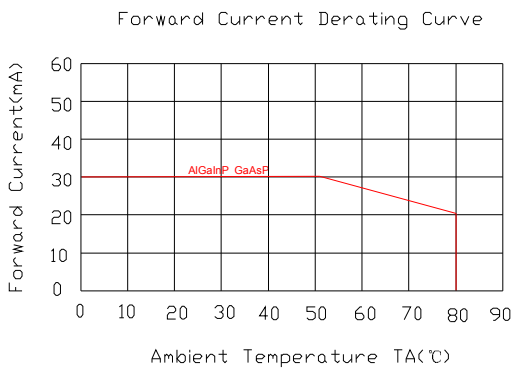
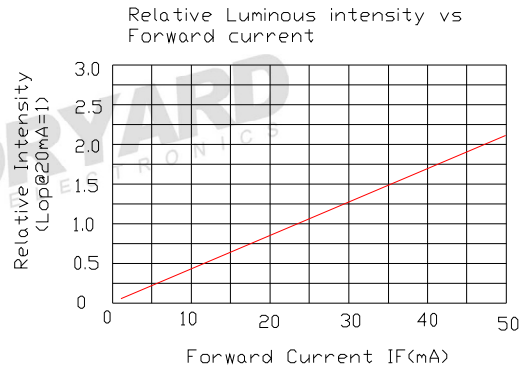
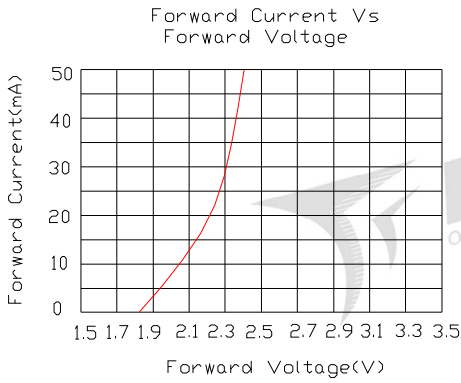
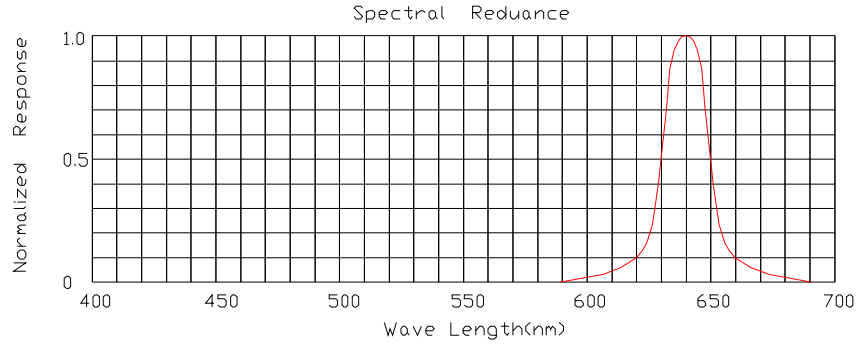

**Radiation pattern**

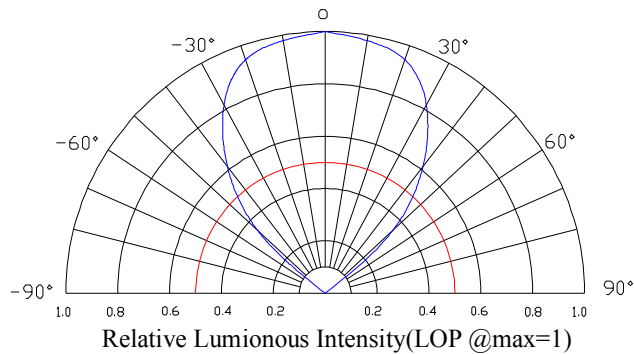

Model No.: FYLF-1130PUR1C

■ LAMP PACKING.

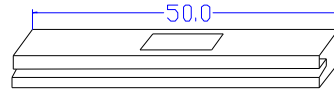
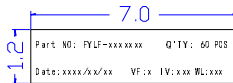
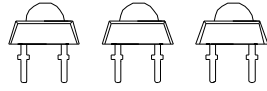

60PCS/1C TUBE

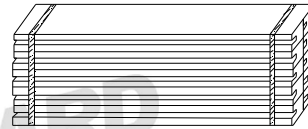

600PCS/10PCS 1C TUBE

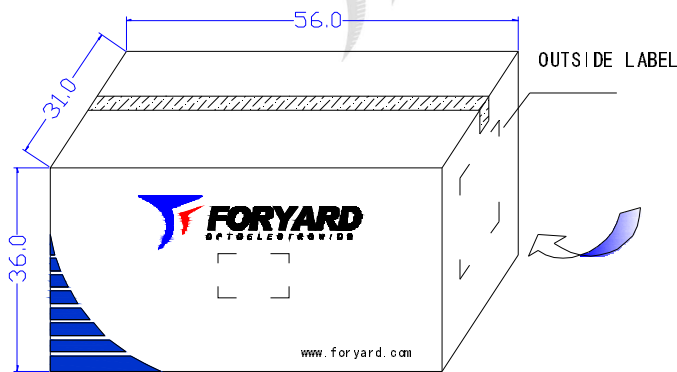

33600PCS/560PCS 1C TUBE

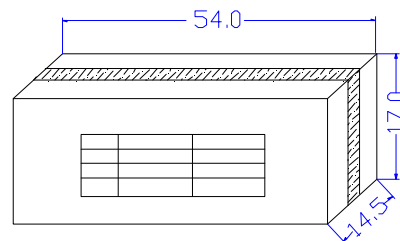

8400PCS/140PCS 1C TUBE



OUTSIDE LABEL

Note: The specifications are subject to change without notice. Please contact us for updated information.