

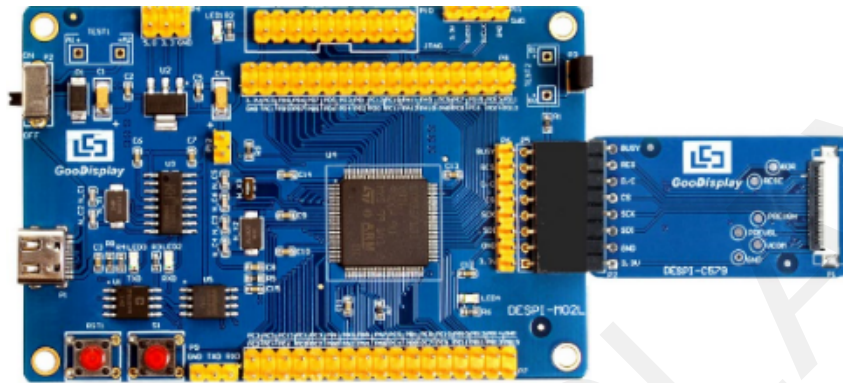

Evaluation Kit for E-Paper Display DESPI-L(C579)

Dalian Good Display Co., Ltd.

Product Specifications



Customer	Standard
Description	Evaluation Kit For E-paper Display
Model Name	DESPI-L(C579)
Date	2022/10/18
Revision	1.0

	Design Engineering		
	Approval	Check	Design
			

Zhongnan Building, No.18, Zhonghua West ST,Ganjingzi DST,Dalian,CHINA

Tel: +86-411-84619565

Email: info@good-display.com

Website: www.good-display.com

Contents

1. Overview	4
2. Mechanical Specifications	4
3. Diagram	5
4. Connection Mode and RESE Selection.....	7
5. Program Downloading	9

GOODDISPLAY

1. Overview

DESPI-L (C579) development kit can help developers to develop projects based on e-paper displays more quickly and smoothly, and is specially designed for SPI e-displays. It supports 5.79 inch e-paper display (black and white and three color), in addition, it also supports USB serial port, LED status indication, reset key, user-defined key, font library chip, Flash chip and other functions, and it is used together with supporting upper computer software.

The DESPI-L (C579) development kit includes the STM32 mainboard DESPI-M02L and the adapter board DESPI-C579.

2. Structure Specification

Parameter	Specification
Model	DESPI-L (C579)
Platform	STM32
Dimension	Mother Board: 90mm x 60mm (DESPI-M02L) Adapter : 41mm x 22mm (DESPI-C579)
Power Interface	USB Type
Example Code	Available
Operating Temp.	-20 ~70 (-4 ~158)
Main Function	Learn to drive E-paper display; Test and evaluate E-paper display; Support secondary development
Additional Function	Type-C, LED indicator light, Reset button, Font chip, Flash chip, Current detection

3. Diagram

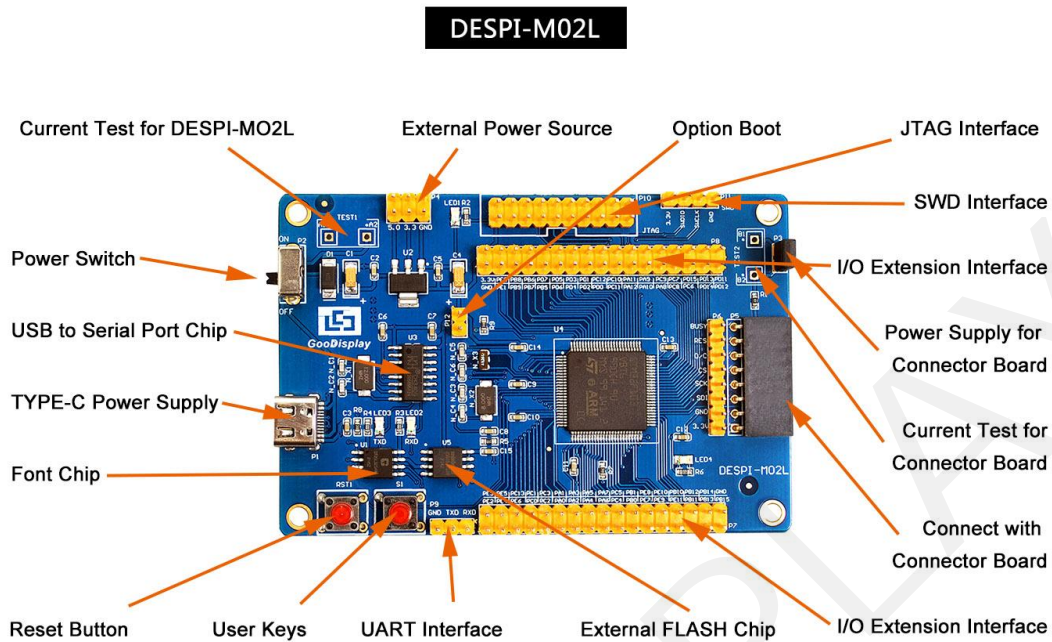

Figure 1: DESPI-M02L

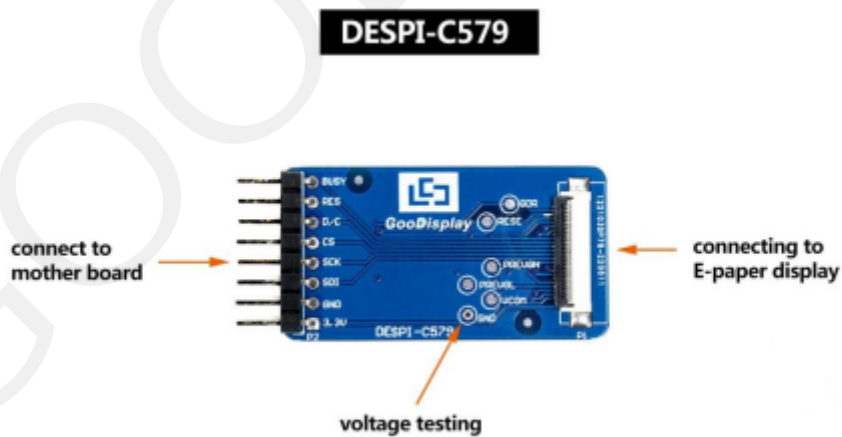

Figure 2: DESPI-C579

3.1 Power Supply

The input voltage of this board is DC5V, which is powered by the USB port.

3.2 USB to serial port

This board has USB to serial port transmission function. Please install the driver program CH340 to use it.

3.3 P3 and P12 short-circuit jumper

- 1) P3: P3 short-circuit jumper controls DESPI-C579's power supply, which is e-paper display's power supply.
- 2) P12: P12 short-circuit jumper is used to select the download mode. You need to connect it when you download a program by UART mode, and remove it after you have downloaded it, otherwise the program will not run. If you connect it, you will not be able to download program by other ways.

3.4 Current measurement

The development kit supports current measurement of DESPI-M02L and DESPI-C579.

- 1) DESPI-M02L: Power off and make series connection between ampere meter and TEST1.
- 2) DESPI-C579: Power on and take off the short-circuit jumper P3, then make series connection between ampere meter and TEST2. Put on the short-circuit jumper P3 after measurement.

3.5 I/O port extension

The I/O port of STM32 has been led out for developing.

3.6 LED indicator light

There is a indicator light reserved for developing.

3.7 Key

This board has two buttons, a reset button and a user button for testing and development.

3.8 Expanded Functions

Built-in Chinese font chip GT 30L 32S4W.

Built-in data storage chip W25Q16.

4. Connection Mode and RESE Selection

4.1 Connection between e-paper display and development board

1) Connect the main board and the adapter board as shown in Figure 3, and connect the electronic paper FPC to the connector of the adapter board as shown in Figure 4.2

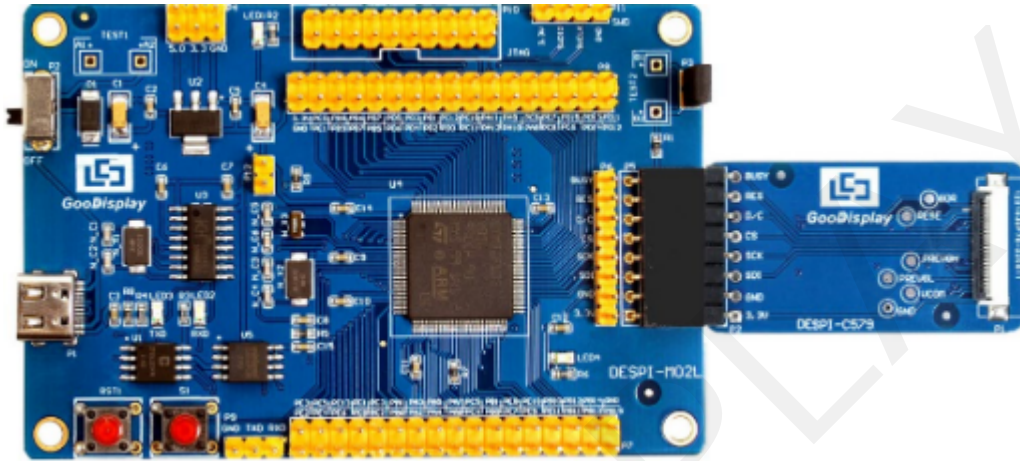

Figure 3 : Connection between main board and adapter

2) Insert the e-paper display face up into the adapter board

Note: The mirror side of the e-paper display is facing down and the display side is facing up.



Figure 4.1 Connection between DESPI-C579 and e-paper display

3) Connect the e-paper display FPC to DESPI-C579 as shown in Figure 4.2. (Pay attention to the direction of the e-paper display.) And set P8 to NC.

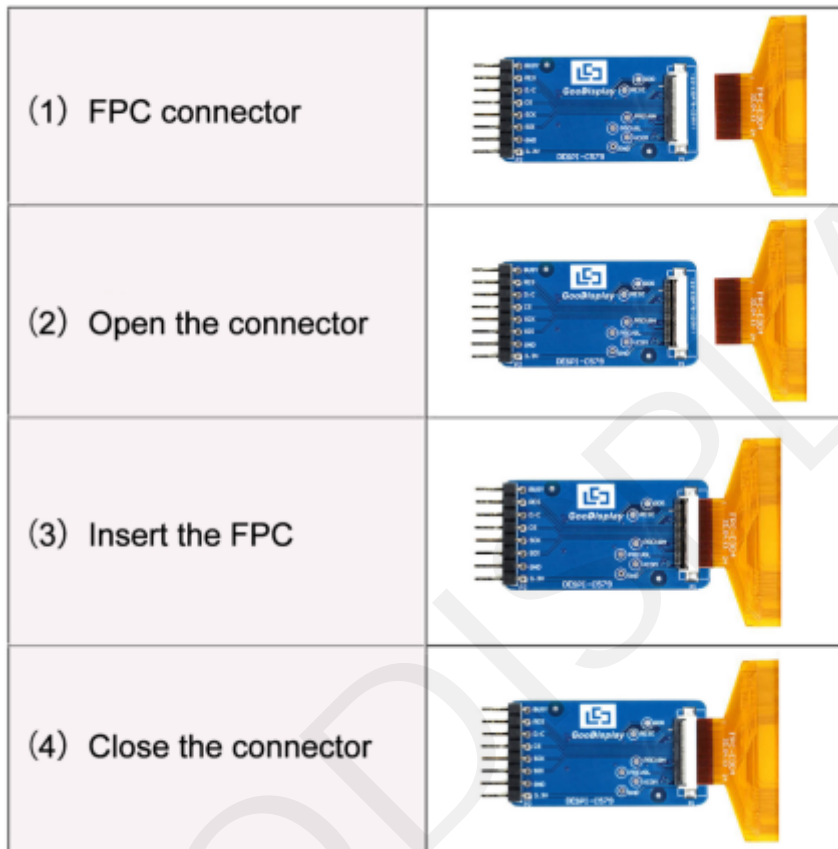

Figure 4.2 : Connection between DESPI-C579 and e-paper display

5. Program Downloading

This development board supports three ways downloading program. They are JTAG, SWD and UART. JTAG and SWD is recommended, because these two can make online downloading available for debug.

5.1 JTAG

We need to use J-link simulator and Keil4, the operation steps are as follows:

- 1) Connect the simulator to DESPI-M02's JTAG interface (align the raised part of the figure 5 simulator interface to the notch direction of the JTAG interface) and connect the computer USB port at the other end.

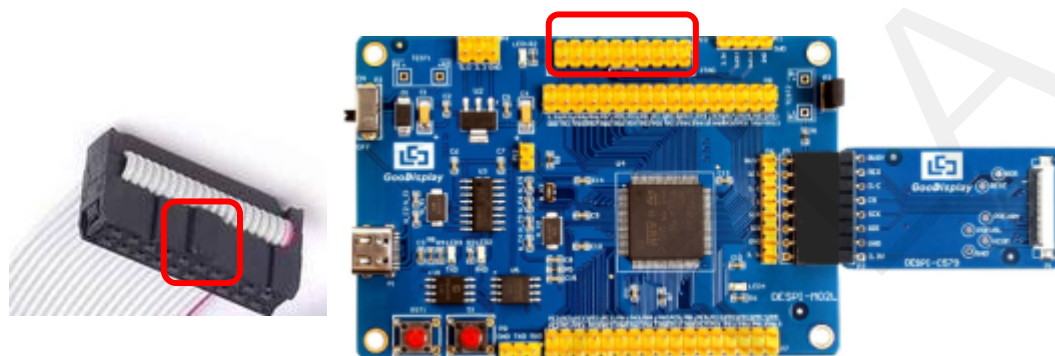

Figure 5 : Connection between JTAG and simulator

- 2) Open the "mdk.uvproj" in the program folder "Project" shown in Figure 6 with Keil4.

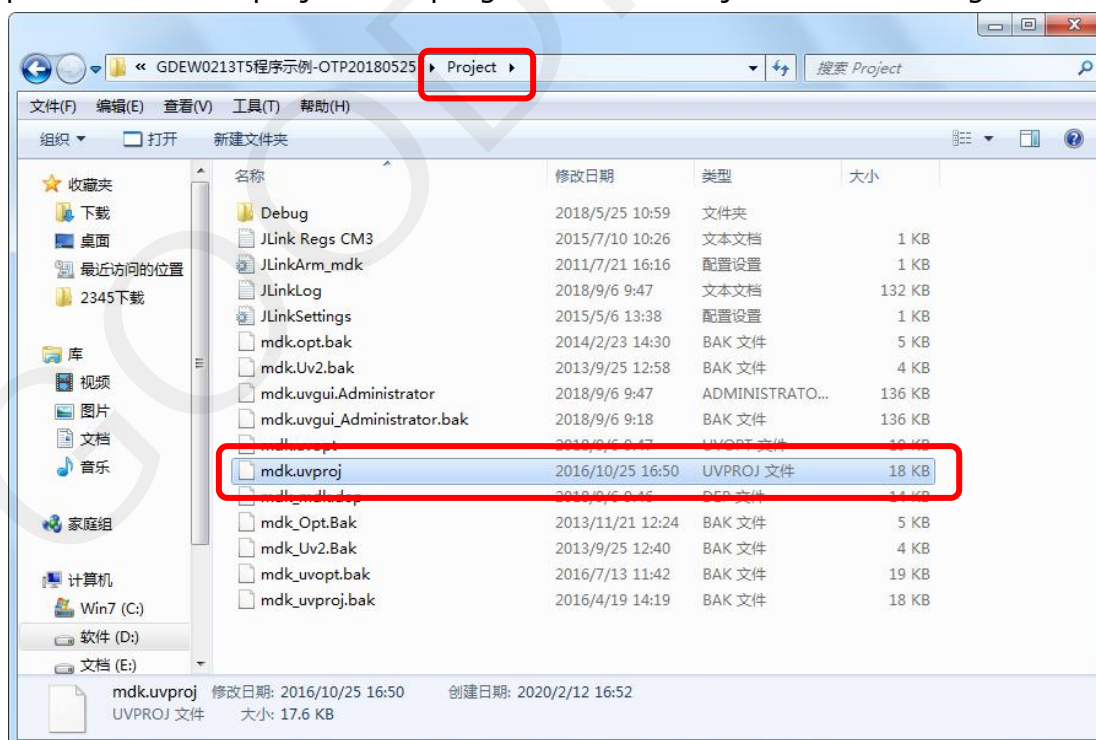



Figure 6 : Open the mdk.uvproj

3) The Keil4 toolbar is shown in Figure 7. Please click  at the first time using the simulator and a box like Figure 1 2 will pop up. Choose the simulator model of yours in the "Debug" bar, and click "OK to confirm.

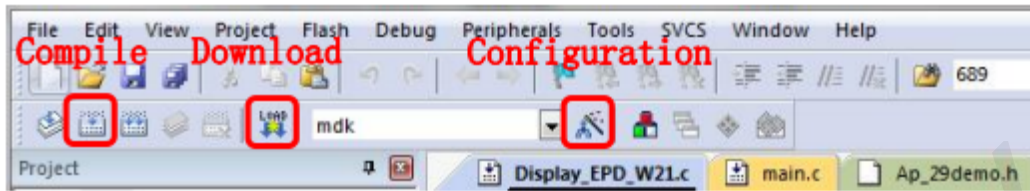

Figure 7 : Keil4 tool bar

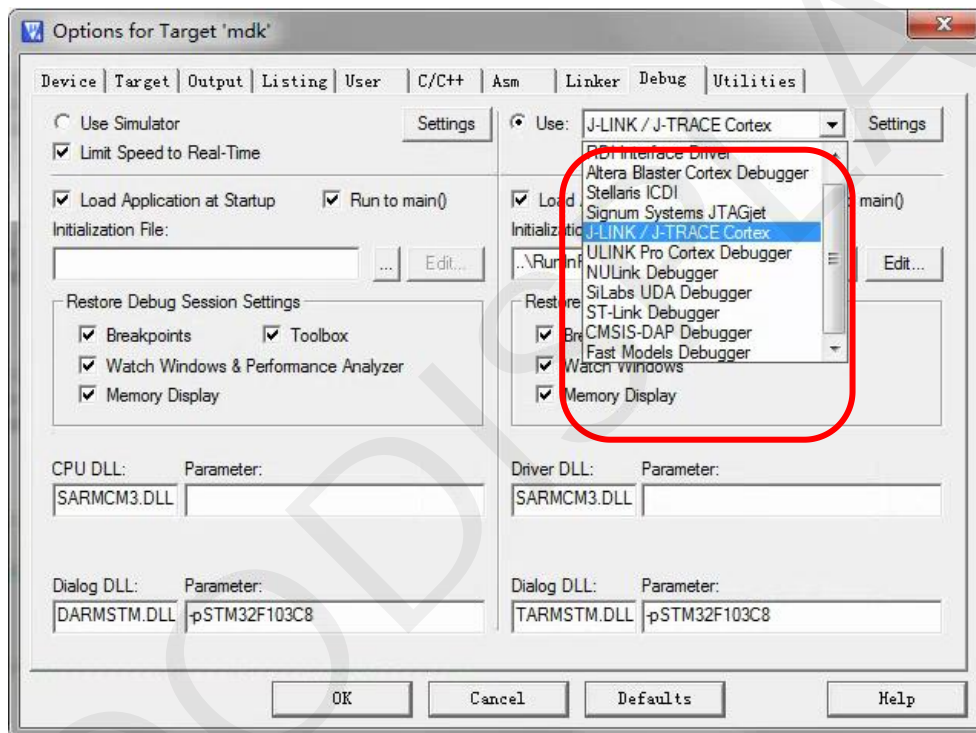

Figure 8: Choose the simulator model

4)Click Ap_29demo.h in Figure 9 to change the image data that needs to be displayed(the image data needs to be achieved by image2lcd).

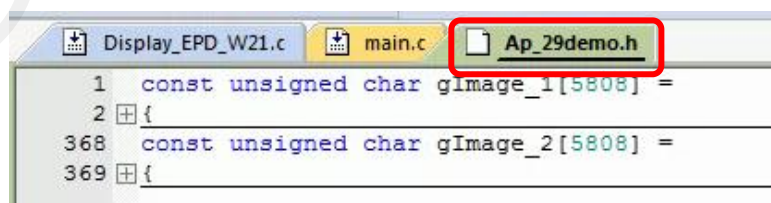



Figure 9 :change the image data

5)Click  in the toolbar in Figure 7 to compile.

6)Click  in the toolbar in Figure 7 to download.

5.2 SWD

We need to use ST-link simulator and Keil4, the operation steps are as follows:

1) As shown in figure 10, DESPI-M02L has a 4-wire SWD interface, which can be connected to the simulator interface by 4 wires and then connect the simulator to the computer.

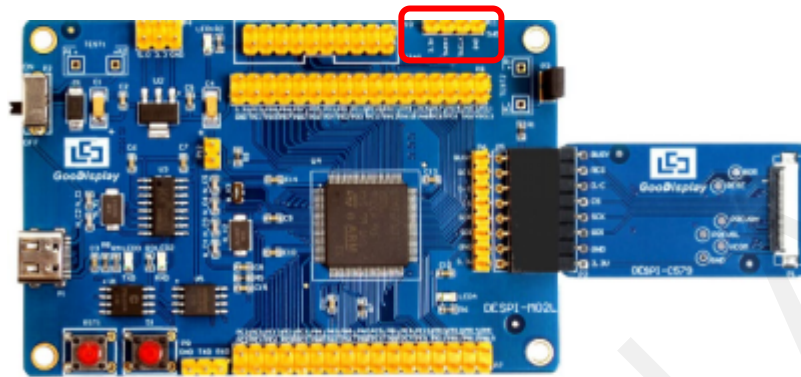

Figure 10:SWD interface

2) Download program with Keil4 by the same steps with JTAG.

5.3 UART

This development board supports USB to serial port download, which need to use Micro USB data cable, CH340 driver and FlyMcu download tool, the operation steps are as follows:

- 1) We need to install the CH340 driver on the computer before downloading for the first time.
- 2) Connect the USB port of DESPI-M02L to the computer with USB data cable.
- 3) Connect P12 with a short-circuit jumper, the position of P12 is shown in Figure 11.

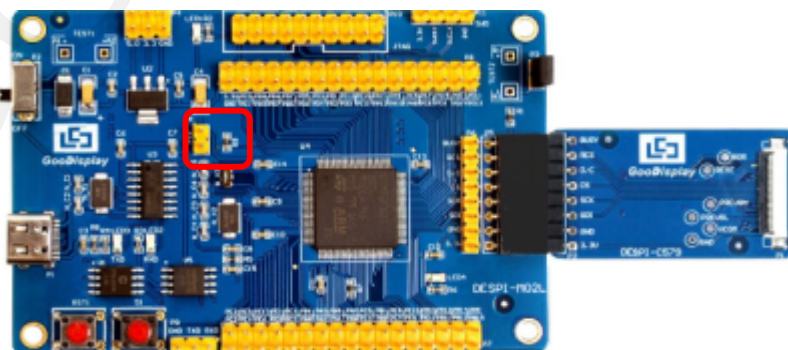

Figure 1 1 :The position of P12

Tips: When downloading a program with UART, P12 must be shorted. And the short-circuit jumper must be removed after downloading, otherwise the program cannot run.

4) Open the FlyMcu downloading tool and configure it as shown in Figure 12.

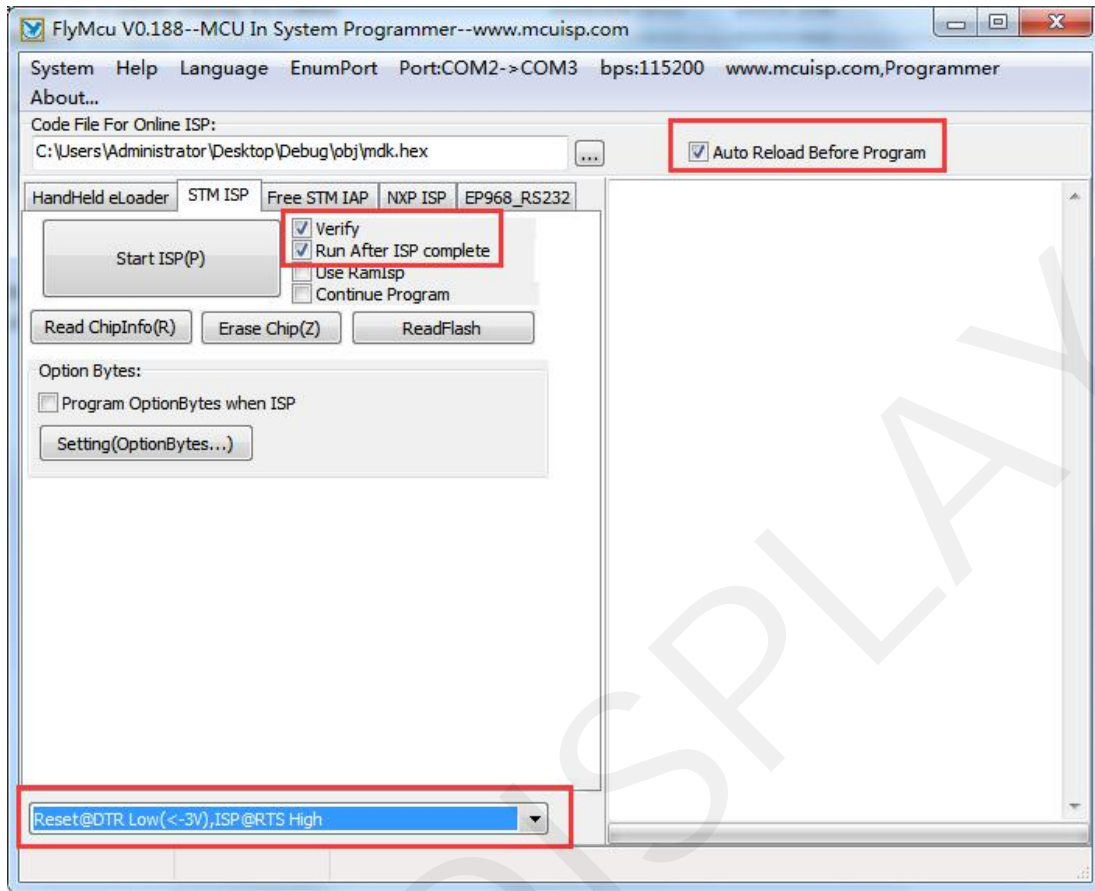

Figure 12: Configuration of Fly Mcu

- 5) Click "Search Serial Port", choose the COM port corresponding to the board, "bps" choose "115200".
- 6) Choose the program file with the file path: Project > Debug > obj > mdk.hex.
- 7) Click "Start ISP" to download.

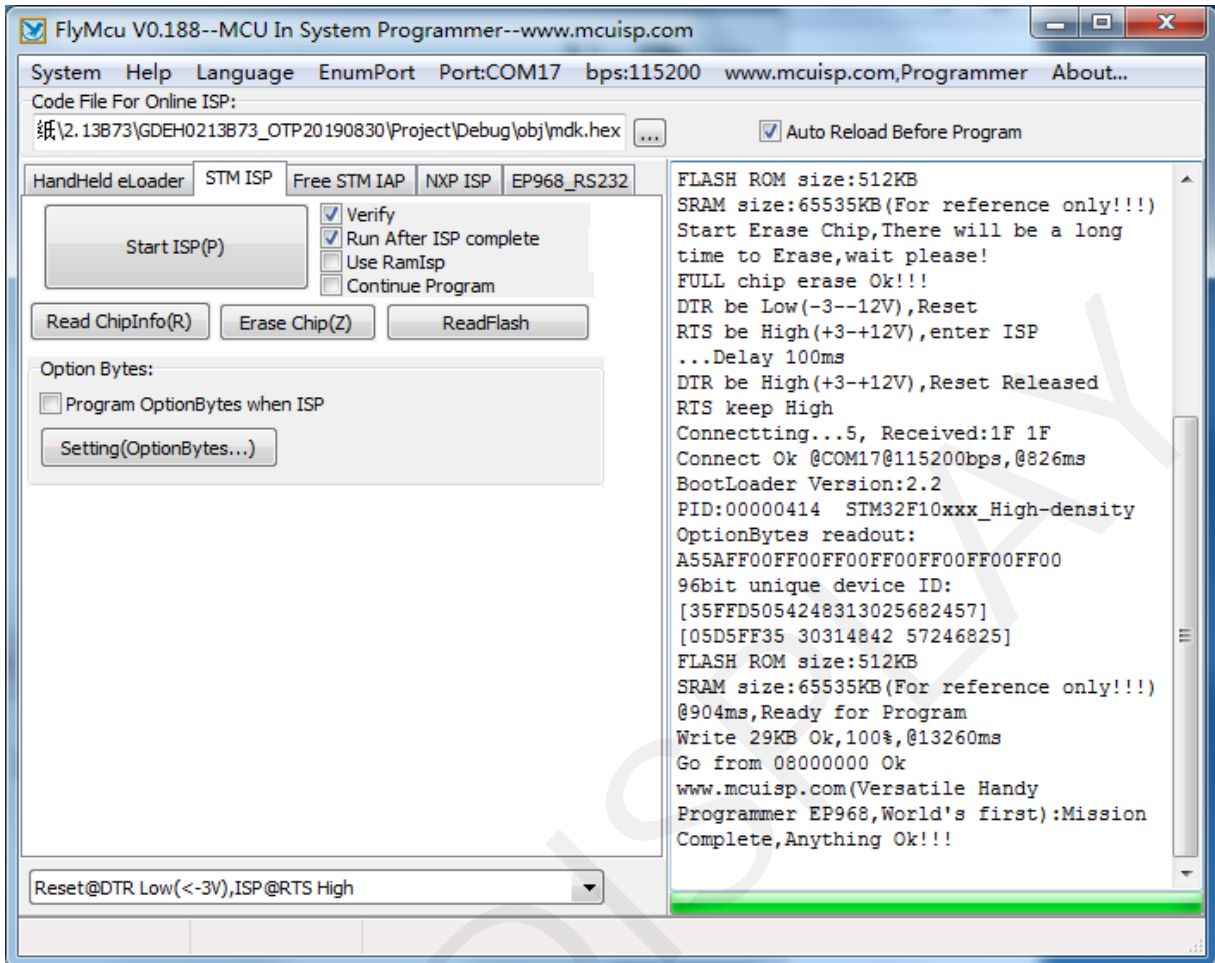

Figure 13 : FlyMcu Program Success

- 8) When download is complete, remove the short-circuit jumper of P12 and re-energize the board, then the program will run.
- 9) If you want to change a image, you need to use Keil4 to change the image data (Figure 9), compile it (Figure 7) to generate a new mdk.hex file, and then re-select the file to download it.