

KSJ®

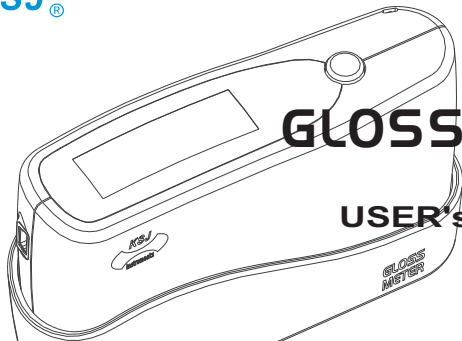

GLOSSMETER

USER'S MANUAL

Model: MG6-F1
MG6-S1

Please read the user manual in details before use. The manual will be changed and subject to the practice for technical updates and without notice.

CE

RoHS

ISO-2813
60° GLOSS

Made in China

Version:20210425

Hidea®

KSJ®

KSJ Photoelectrical Instruments Co., Ltd.

Add: 264 Huangling, Zhangban Town, Taiwanese Investment Zone,
Quanzhou, Fujian 362123, China.

Tel.: +86-595 – 22391041

Fax: +86-595 – 22391048









Website: www.ksj.cn
www.glossmeter.cn

E-mail: sales@ksj.cn
sales@hidea.cn



en.ksj.cn

Precautions	2
Brief Introduction	3
Main Technical Parameters	4
Components and Functions	6
Basic Operations	10
Operation of Mobile Software	13
Measurement with Computer	19
After-sales Service	23
Delivery List	24

-  The meter must be used under the temperature between 5°C ~ 45°C and relative humidity less than 85 % with no moisture condensation.
-  Don't stick any foreign objects to the plane of the Measurement Aperture.
-  While measuring, it is necessary to keep away from a strong EMI.
-  If there is a big difference of temperature between a meter and the environment, please wait for a temperature balance, and then recalibrate the meter for a measurement.
-  Use a battery properly to prevent from fluid leakage causing the meter damaged. Please dispose wasted batteries in accordance with Local and National Disposal Regulations.
-  Although the exterior parts of the meter are made of good quality plastic, they may not resist some chemicals, especially some strong solvents, such as acetone and so on.
-  The whole set of the meter should be kept in a dry, non-corrosive environment and under the temperature between -10°C to +60°C.
-  When stored remove a battery from the meter.
-  The limited warranty period is two years commencing on the date of purchase. We reserve the rights not to guarantee those breakdowns free in repair that are caused by inappropriate use or being taken down.

©2014 KSJ instruments. All rights reserved.

KSJ and Hidea are both registered trademarks in China and other countries.

All other trademarks are property of their respective owners.

Thanks, and welcome to use the KSJ glossmeter!

The glossmeters are designed and manufactured according to ISO 2813 and GB/T 9754 and compatible with the standards of ASTM D2457, ASTM D523, GB/T 13891, GB/T 7706, and GB/T 8807. The technical parameters conform with JJG696–2015. The gloss values can be traced to the those of the National Primary Standards in SIMT in China.

Main Applications:

- All kinds of coating and finishing surfaces, such as paints, varnishes, printing ink, etc.
- Decorative materials, such as marble, granite, polishing brick, ceramic tile and so on.
- The other kinds of materials and objects, such as plastic, woodenware, paper, etc.

Main Technical Parameters

Specifications	Unit	MG6-F1	MG6-S1
Reading Range	GU	0 ~ 199.9	0.0 ~ 199.5
Resolution	GU	0.1	0.5
Deviation	GU	≤1.2	≤2.0
Zero-point Deviation	GU	≤0.2	≤0.5
Stability	GU	≤0.4	≤1.0
Light Spot	mm	10 × 20	
Measurement Aperture	mm	14 × 30	
Incidence Angle	DEG	60 °	

☆ Note: GU is short for Gloss Unit.

Main Technical Parameters

5

Specifications	Unit	MG6-F1	MG6-S1
Operating Environment		5°C ~ 45°C, up to 85%RH, no moisture condensation.	
Storage Temperature		-10°C ~ +60°C	
Power Supply		One AA-size battery, 1.2V ~ 1.5V, Rechargeable or alkaline.	
Consumption		It's different to battery types. An alkaline battery may last the meter to work more than 58 hrs without backlight and Bluetooth.	
Main Volume	mm	123 × 65 × 38	
Main Weight	g	300	

Front

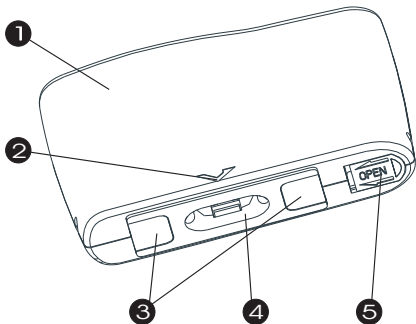

- ① Front Cover
- ② Mark for Location Incidence Direction
- ③ Info Labels
- ④ Measurement Aperture
- ⑤ Battery Cabin Cover

Rear

- 6** Display Screen
- 7** Switch Key
Long press for On/Off.
Short press for Calibration.
- 8** M Key
Long press to Switch Bluetooth.
Short press to upload data.
- 9** Mark for Location
Incidence Direction

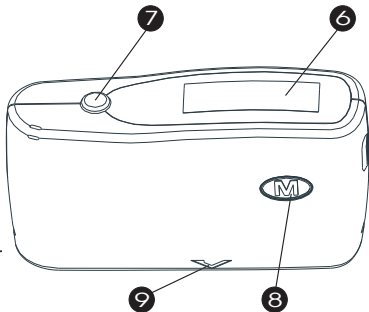

■ Holder With Calibrating Tile

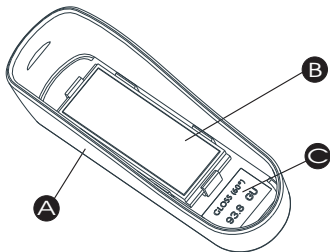

- A** Holder
- B** Calibrating Tile (Working Standard)
- C** Gloss Value Label

Battery Changing

D Front Cover

E Cabin Cover

F AA-size Battery

G Rear Cover

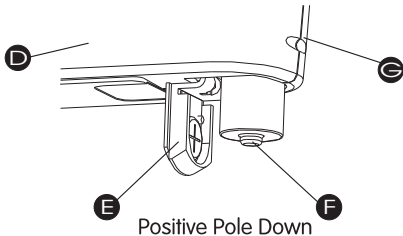

■ Startup and shutdown

After long pressing the Switch Key to turn on the meter, it will be automatically calibrated. And the meter will be shut down automatically after long pressing that key or reaching the set standby time.

☆ Notes:

1. The meter must be properly buckled into the Holder, otherwise, self-calibration cannot be performed.
2. If the E0 or E1 prompt pops up in the upper left corner of the window, the Calibrating Tile in the Holder is contaminated or damaged, and the gloss value should be lower than that of labeled.
 - E0 : The deviation is greater than 1.5GU and less than 3GU.
 - E1 : The deviation is greater than 3.0 GU.In this case, please check and clean it before use. Refer to page 11~12.
3. Please refer to page 17 for setting the standby time.

■ Meter Calibration

After starting up the meter, press the Switch Key, the meter enters the calibration state, "CA" is flashing in the upper left corner. And then, press the key again to complete the calibration.

☆ Note: The meter must be located in the holder properly.

■ Measurement

By removing the Holder and placing the Measurement Aperture of the meter just against the position at which we want to measured, the value displayed on the screen is the gloss value at that position.

☆ Note: To get an accurate measurement, the meter should be re-calibrated in time, and the Calibrating Tile should be kept clean.

■ Notes for operation

- ◆ The lens in the Measurement Aperture, the surface of the Calibrating Tile and the position measured, etc should be kept clean. If those surfaces get dirty with dust, steam of filth, fingerprint, etc, they must be cleaned lightly with lens paper or a soft cloth dipped with absolute ethanol.

- ◆ While measuring, keep environment light from directly irradiating into the Measurement Aperture.
- ◆ Calibrating and measuring should be carried out at the same ambient temperature. A large difference between the meter and the environment in temperature would bring about a big deviation.
- ◆ When the battery run out, the symbol of " " will appear on the Display Screen, replace the old battery with a new one at once.
- ◆ If the meter is not in use, please put it into the Meter Holder.
- ◆ Gloss quantity is denoted by $G_s(X)$, e.g. $G_s(60^\circ)=78GU$. The expression says that a measurement at incidence angle of 60° is 78 Gloss Unit.

The meters can be used with the KSJ Data Operator (data processing software) on the mobile end, making the measurement more convenient, data storage and processing simpler! The software on the mobile end is briefed below. For detailed instructions, please refer to the software help.

★ Hints: you can also use the software for the PC end if you download it and buy an optional Bluetooth adapter. See page 20.

■ How to get software

User can find the software for different ends on the USB disk provided with the meter or scan QR code below as per different ends to get it, or search and download it in a mainstream application store.

■ Instructions of the software

1. It should be Android 4.4 or above, and iOS 9.0 or above.
2. The storage permissions are required for accessing data when the software is installed on the mobile end.
3. User can get help from the Help menus during the use of the software. Moreover, you can also get



Android





iOS

technical support by contacting with our company via contact Information mentioned in the manual or on the Internet.

4. The meter belongs to 1st series produced by our company. The software is effective in the following operations:

- A. Online measurement is implemented between the meter and the software via Bluetooth connection.
- B. The Calibrating Standard values and the standby time of the meter can be modified on the mobile end.
- C. Look up the online measurement data and historical data uploaded on the mobile end and export it as an Excel file (data export cannot be access restriction).

■ Bluetooth connection

1. Turn on the meter and open the mobile software;
2. Turn on the Bluetooth on the meter end: Long press the M Key;
3. Click the Bluetooth symbol of the software, then click "Search Device".
4. Select the name of the device searched to implement Bluetooth connection. And then, the Bluetooth symbol on the meter stops flashing. The Bluetooth symbol on the software end is changed from  to .

☆ Explanation: Only one meter can be connected via the Bluetooth, even though several meters turn on the Bluetooth at the same time.

■ Online measurement

After connecting to Bluetooth, click "☰" on the pull-down menu in the upper right corner and click "Online". The software interface is shown on the right.

- ◆ Measure: Measured data of the meter are saved in the software immediately, and the function can be also implemented through pressing the M Key of the meter.
- ◆ New group: A new group is created for measurement. At this time, the number of measurements included in each group can be set. When the group is filled up with data, a new group is created automatically.
- ◆ Delete: Delete the measurement data saved newly.

■ Setup

Click "☰" on the pull-down menu in the upper right corner and click "Setup" for presetting. The interface settings are described as follows:

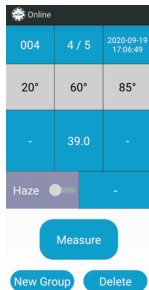

- ◆ Language: Set the software display language. There are eight languages to choose from.
- ◆ Acceptable Range: Any data beyond the limit are highlighted in red upon setting.
- ◆ Clear All: Clear data stored in the software. Please use it with caution!
- ◆ Factory Settings: Restore initial settings of the software.

■ Meter Settings

After connecting to Bluetooth, click "⋮" on the pull-down menu in the upper right corner and click "Meter Settings" for setting the meter end. The software interface is shown on the right.

- ☆ Explanation: All options in rectangular boxes are disabled for the current model.
- ◆ Modify Value: Set or modify verified gloss values of the Calibrating Tile on the Holder.
- ☆ Note: Normally, the values of the Calibrating Tile stored

Angle Mode

Group Size

Verified Values

Standby Time

Clear Memory

Language

Time Syn

LCD Backlighting

in the meter is consistent with the values marked on the Holder, which is the basis for calibrating the meter and can not be changed arbitrarily. The operation will only be implemented when the Calibrating Tile is re-evaluated after checking or a new one is used.

◆ Standby Time: Time interval for automatic shutdown without operation is set. There are four options.

☆ Hint: If you select "OFF", the meter won't be off automatically. The meter will be off by long pressing the Switch Key. Please process it with caution!

◆ LCD Back Lighting: Turn on/off the function. It is not available for MG6-S1.

■ Data search

The software can be used with multiple glossmeters manufactured by our company, which can also receive and store measured data from multiple meters. Therefore, the meter serial number (1 for this series) and the hardware number should be specified for querying. To be sure, data can be also queried with the additional time and group name.

- ◆ Press " Q " to open the search tool;
- ◆ Search by Time: It's off by default. By clicking the "Off" key to open it, the start and end time can be set for query.
- ◆ Group Name: Enter the group name or group number.

■ Export data

After connecting to Bluetooth, click " ⋮ " on the pull-down menu in the upper right corner and click "Export" to export data in the current data area to the KSJDATA folder in the mobile memory area in the format of Excel file.

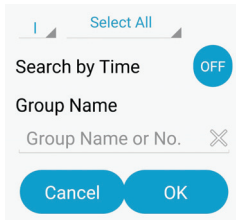

■ Introduction to KSJ Data Operator

With the software of KSJ Data Operator (only Windows version is currently available) we can establish a communication between the meter and a computer with a Bluetooth adapter and implement online measurement. In addition, the data can be stored, processed and exported.

- ☆ Hint: 1. The Bluetooth adapter is an optional accessory, and specially spaired with the meter, it should be bought separately during the meter ordering.
2. This software can run on Windows 7 or above versions. Please refer to the software help for detailed usage.

■ Acquisition and installation of KSJ Data Operator

You can obtain the software on the USB disk provided with the meter, or scan the QR code on the right and log in to the company's website for software download.

The installing and uninstalling process of the software is similar to that of the general software, just following the hints. During installation, the installation path can be changed.

- ☆ Hint: Please back up the database file KDO.mdb in the installation directory on a regular basis to prevent data loss.



■ Bluetooth adapter driver installation

The Bluetooth adapter needs to install the driver. The files of the driver and the Guide for installation of BT Adapter Driver can be find in the U disk coming with the meter. Please follow the guide and finish the installation.

☆Hint: The Bluetooth adapter and the meter are specially paired, and it is an optional accessory, so that it should be bought separately during the meter ordering.

■ Use of Bluetooth adapter

Once the software and the Bluetooth adapter driver are installed, it is easy to establish communication between the meter and the computer. Please follow the process as below.

1. Plug the Bluetooth adapter into a USB port, its LED starts blinking.
2. Turn on the meter, then press and hold the M key to start the Bluetooth function. The Bluetooth logo should appear on the meter screen, then the adapter LED stops blinking. The communication between the two has been established.

☆Hint: Certainly, some computers with the Bluetooth function can be also used for searching and pairing the meter Bluetooth.

■ Connection to the meter and measuring online

After the above work is completed, online measurement can be carried out. Please operate as following.

1. Start the software, and click the Connect button to link both of the software and the meter, then the meter ID should be recognized by the software.
2. Select Online Measurement tab, there are four buttons on it, the functions are as below:
 - ◆ Start: Start online measurement. After clicked, it turns to become Measure button.
 - ◆ Measure: Make a measurement. It is the same as the M key.
 - ◆ New Group: Create a new group.
 - ◆ End: Terminate online measurement.

☆ Hints:

1. Online measured data are uploaded to the software in chronological order.
2. Some functions of the software may not be valid for the meter.

■ About Data Processing

◆ Group Data area

This area displays group data, including name, size, measurement angle, average, standard deviation, P/F, maximum, minimum, and upload date. Of which, "P/F" is used for determining whether the average of this group is within maximum and minimum values set by the active set of reference values, displaying with "pass" or "fail".

◆ Original Data area

After checking the box before the group name, measured data of this group can be displayed in this area, which consists of group name, serial number, measured value and deviation of each measurement angle. Specifically, "deviation" refers to the difference between the measured value and the preset reference value.

◆ Search Data

After clicking the Search button on the Search tab, a search dialog box pops up, then select the series (the second digit of the meter ID) and the meter ID, and set search conditions to search data.

- ◆ The meter is warranted for two years. Please contact the dealer or our company for troubleshooting once there is any problem to the meter.
- ◆ We always provides users with spare parts and life-long maintenance services.
- ◆ We provides users with meter calibration services for free.
- ◆ We provides technical consultation at no charge.
- ◆ We provides the design and customization of gloss measuring meters in special specifications and applications.

☆ Notes:

1. Disassembly might affect the measuring accuracy of the meter and lead to maintenance difficulties.
2. Free warranty is not guaranteed for improper use or disassembly during the warranty period.
3. The warranty card is an evidence for maintaining. Please verify the information on your warranty card to protect your own rights and interests!

Delivery List

◆ Main Device	Model: MG6-F1	<input type="checkbox"/>	1 piece
	MG6-S1	<input type="checkbox"/>	1 piece
◆ Holder with Calibrating Tile (Working Standard)			1 set
◆ Checking Tile (Spare Working Standard)			1 piece
◆ Carrying Bag			1 piece
◆ U Disk (including software and files)			1 piece
◆ User Manual			1 piece
◆ Inspection Certificate			1 piece
◆ Warranty Card			1 piece
◆ Optional Accessory: Bluetooth Adapter		<input type="checkbox"/>	

☆ Hint: The Bluetooth adapter and the meter are specially paired, so that it should be bought separately during the meter ordering.