

Product Description

LF-GSD030YE series is a 30W constant current LED driver. It has DALI dimming and PUSH dimming functions. The input voltage range is 198-264Vac. The output current can be adjusted via the DIP switch from 550mA to 750mA, in steps of 50mA.

Features

- IP20
- Metal casing
- Suitable for Class I & II light fixtures
- Constant current output and the output current can be adjusted via the DIP switch
- Built-in active PFC function
- Standby power consumption <0.5W
- 0.1% dimming depth
- Supports DALI dimming and the logarithmic and the linear dimming curves can be selected via the software
- Supports PUSH dimming
- 5-year warranty (Please refer to the warranty condition.)

Applications

- Horticultural lighting
- Indoor office lighting
- Decorative lighting
- Commercial lighting
- Residential lighting



Product Naming

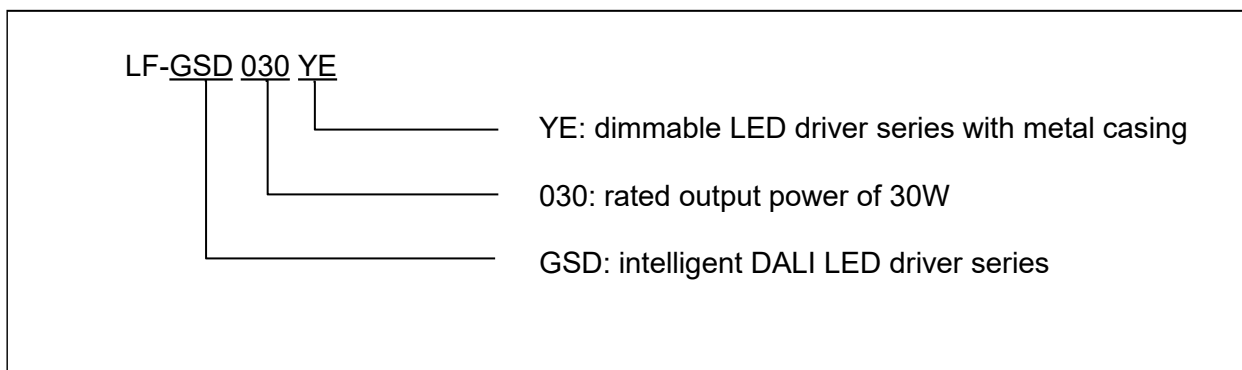

Electrical Characteristics

Model		LF-GSD030YE (0.1% dimming depth)				
Output	Output Voltage	25-42V				
	Output Current	The output current can be adjusted via the DIP switch. Please refer to the DIP switch table.				
		550mA	600mA	650mA	700mA	750mA
	Flicker Index	IEC-Pst \leq 1, CIE SVM \leq 0.4, Modulation Depth \leq 1% Conforms to the flicker free standard (IEEE Std 1789-2015)				
	Ripple Current	<5% (rated current)				
	Current Tolerance	\pm 5%				
	Temperature Drift	\pm 10%				
	Start-up Time	<1.4S @230Vac				
Input	Input Voltage	220-240Vac (voltage limit : 198-264Vac)				
	DC Input Voltage	310-340Vdc (voltage limit : 280-374Vdc)				
	Input Frequency	47-63Hz				
	Input Current	0.2A Max				
	Power Factor	\geq 0.95				
	THD	\leq 15% @230Vac (DC42V full load)				
	Efficiency	\geq 86%				
	Inrush Current	\leq 80A@350uS@230Vac (Max)				
	Load Quantity Carried by the Circuit Breaker	Circuit Breaker Model	B10	C10	B16	C16
		Quantity (pcs)	33	33	53	53
	Surge Protection	L-N: 1KV; L-N-GND: 2KV				
	Leakage Current	\leq 0.7mA				
	Stand-by Power Consumption	\leq 0.5W (when the DALI OFF signal is effective)				
Protective Features	Open-Circuit Protection	<55V				
	Short-Circuit Protection	Hiccup mode (auto-recovery)				
Environment Conditions	Operating Temperature	-30 $^{\circ}$ C ~ +50 $^{\circ}$ C				
	Operating Humidity	20-90%RH (no condensation)				
	Storage Temperature/Humidity	-30 $^{\circ}$ C ~ 80 $^{\circ}$ C (six months under class I environment); 10-90%RH (no condensation)				
	Atmospheric Pressure	86-106KPa				

Safety & Electromagnetic Compatibility	Certifications	TUV-ENEC, CCC, RCM, CE, CB
	Withstanding Voltage	I/P-O/P: 3.75KVac 5mA 60S
	Insulation Resistance	I/P-O/P (LED): 3.75KVac, O/P(LED)-O/P(DIM): 500Vac, I/P-O/P(DIM): 500Vac
	Safety Standards	ENEC: EN61347-1: 2015, EN 61347-2-13: 2014/A1: 2017, EN 62384: 2016/A1: 2009; CE-LVD: EN 61347-2-13: 2014/A1: 2017, EN 61347-1: 2015, EN 62493: 2015; RCM: AS 61347.2-13: 2018; CB: IEC 61347-1: 2015, IEC61347-2-3: 2014, IEC 61347-2-13: 2014/AMD1: 2016; CCC: GB19510.1-2009, GB19510.14-2009
	EMI	CE-EMC/RCM: EN55015, EN61000-3-2, EN61000-3-3 CCC:GB/T17743, GB17625.1, GB17625.2
	EMS	CE-EMC/RCM: EN61000-4-2, 3, 4, 5, 6, 11 CCC: GB/T17626.2, 3, 4, 5, 6, 11
Others	IP Rating	IP20
	RoHS	RoHS 2.0 (EU) 2015/863
	Warranty Condition	5 yrs (TC≤68℃)
	DALI Standard	IEC 62386-101 102 207: DALI 2.0
Remarks	<ol style="list-style-type: none"> 1. It is recommended that customer should install overvoltage and undervoltage protection devices and surge protection devices in the power supply circuits of the light fixtures to ensure safety before connecting to electricity. 2. Please disconnect the AC input before adjusting the output current via the DIP switch. 3. The PC cover, casing, end caps and other parts of the LED driver inside the LED light fixture must conform to UL94-V0 flammability standard or above. 4. As an accessory, the LED driver is not the only factor determining the EMC performance of the LED light fixture. The structure and the wiring of the light fixture are also relevant. Thus it's strongly recommended the LED light fixture manufacturer should re-confirm the EMC of the whole LED light fixture. 5. Unless otherwise stated, the parameters above are test results under these conditions: ambient temperature 25℃, humidity 50%, input voltage 230Vac and 100% load. 	

Product Characteristic Curves

■ **PF Curve**

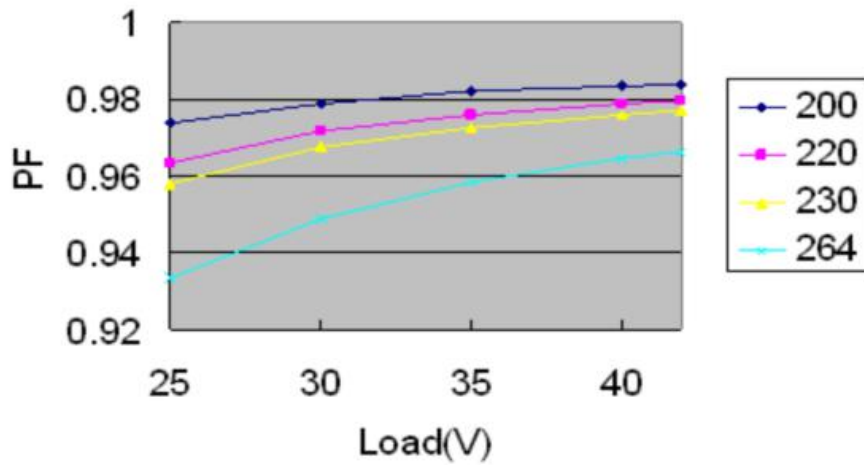

■ **Efficiency Curve**

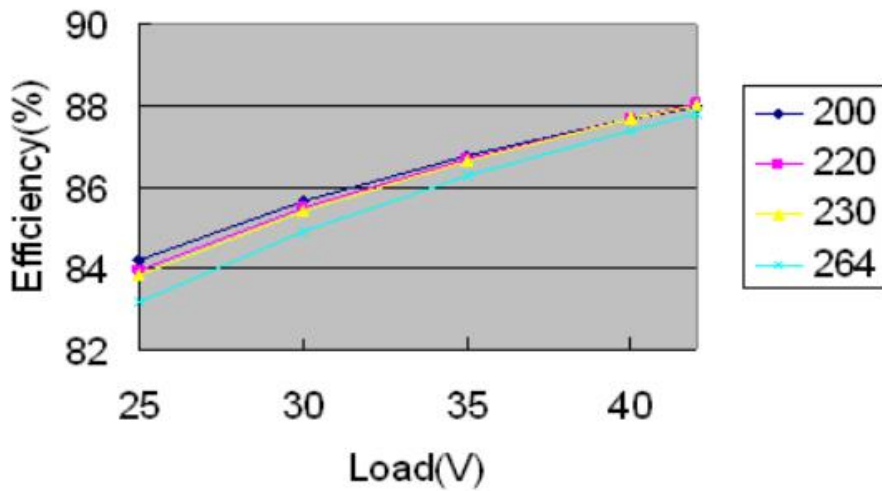

■ **Lifetime Curve**

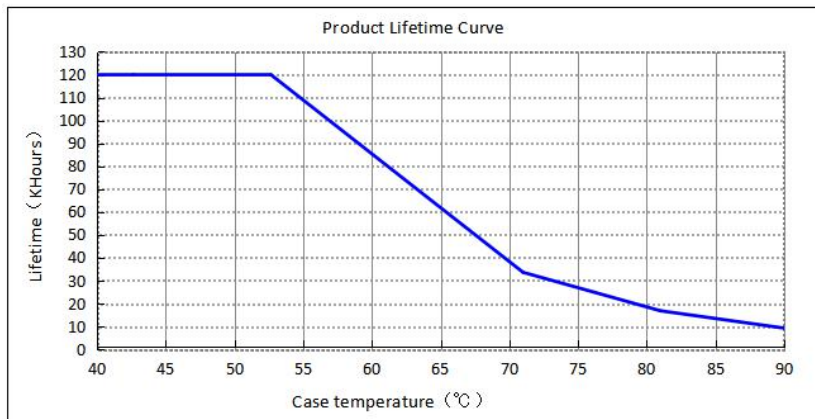

Instructions of Dimming Operation

■ Definition of the Driver's Terminals

INPUT

AC-L	Input terminal of AC live wire
AC-N	Input terminal of AC neutral wire
NC	Vacant
	Grounding wire
DA1 PUSH	Input terminal of DA1 and PUSH dimming
DA2 PUSH	Input terminal of DA2 and PUSH dimming

OUTPUT

LED+	Positive electrode output of the driver
LED-	Negative electrode output of the driver

■ Definition of the DIP Switch

I rated (CC)	1	2	3
750mA	—	—	—
700mA	—	—	ON
650mA	—	ON	—
600mA	—	ON	ON
550mA	ON	—	—

Remark: Except the settings mentioned in the table above, other DIP switch settings are default to be the maximum current 750mA.

■ Wiring Diagram of PUSH Dimming

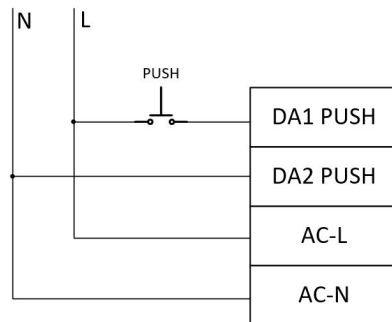

1. The PUSH switch shall be connected between AC-L and DA1 PUSH terminals and DA2 PUSH terminal shall be connected to AC-N.
2. AC-L and AC-N cannot be directly connected to DA1 PUSH and DA2 PUSH terminals.
3. Before AC power is on, please ensure that the PUSH switch is disconnected. After AC is powered on, PUSH operation can be performed.
4. Before AC power is off, please ensure that the PUSH switch is disconnected
5. If you have any questions about the above wiring and the operation methods, please confirm with FAE of our company.



Wrong wiring method or wrong operation method may cause the damage of LED driver.

■ **Instruction of PUSH dimming**

Operation	Operation Time	Function
Instant Push	0.1 ~ 0.5S	Light on / off
Long Push	0.6 ~ 10S	Dim up / down
Reset Push	> 11S	Reset to the 100% brightness

- The PUSH operation won't cause any variations if it's less than 0.05 sec.
- The minimum dimming depth of PUSH dimming is 1% (lout).
- The PUSH dimming mode has the memory function in case of any power failure. When the power supply is restored, the light will return to the exact status before power failure.
- The maximum length of the leading wire from the PUSH switch to the farthest LED driver is 135m. The wire diameter range is 16-22AWG.
- The maximum number of parallel LED drivers in DALI&PUSH mode is 64 pcs.

■ **Instruction of DALI dimming**

- Factory default setting is of 100% brightness.
- Connect the DALI signal to the DA1 and DA2 terminals.
- DALI protocol includes 16 groups and 64 IP addresses.
- The minimum dimming depth of the DALI dimming is 0.1% (lout).

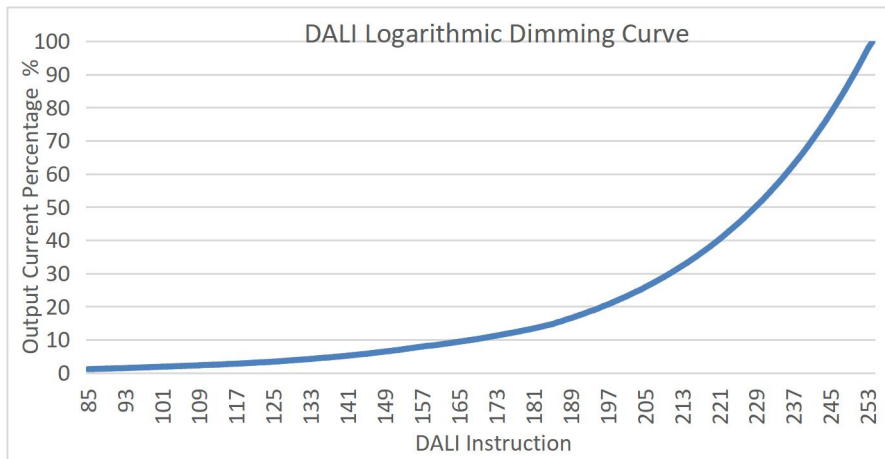
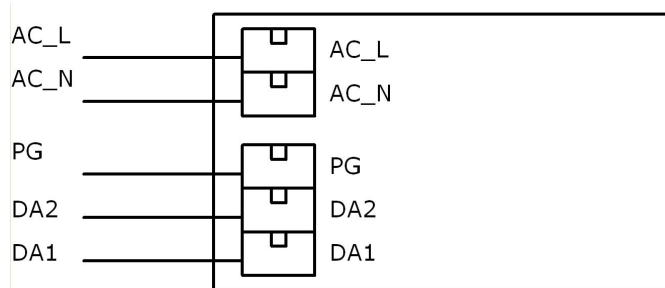

The DALI dimming function and the PUSH dimming function cannot be used at the same time, otherwise the DALI dimmer will be damaged.

Label

INPUT AC-L AC-N NC DALI PUSH DALI PUSH 0.75-1.5		Un: 220-240V ~ In: 0.2A	LED Driver Model: LF-GSD030YE For LED modules only		<table border="1"> <tr> <th>rated I_{CC}</th> <th>1</th> <th>2</th> <th>3</th> </tr> <tr> <td>550mA</td> <td>ON</td> <td>—</td> <td>—</td> </tr> <tr> <td>600mA</td> <td>—</td> <td>ON</td> <td>ON</td> </tr> <tr> <td>650mA</td> <td>—</td> <td>ON</td> <td>—</td> </tr> <tr> <td>700mA</td> <td>—</td> <td>—</td> <td>ON</td> </tr> <tr> <td>750mA</td> <td>—</td> <td>—</td> <td>—</td> </tr> </table>	rated I _{CC}	1	2	3	550mA	ON	—	—	600mA	—	ON	ON	650mA	—	ON	—	700mA	—	—	ON	750mA	—	—	—	Preparation for input and output 7.5mm www.lifud.com Made in China	OUTPUT LED+ LED- 0.5-1.0
		rated I _{CC}			1	2	3																								
		550mA			ON	—	—																								
		600mA			—	ON	ON																								
650mA	—	ON	—																												
700mA	—	—	ON																												
750mA	—	—	—																												
Fn: 50/60Hz	Output Voltage: 25-42V	Prated: 31.5W(Max)																													
U _{out} : 55V	tc: 90°C	PF: 0.9C																													
ta: 50°C																															

Dimensions (unit: mm)

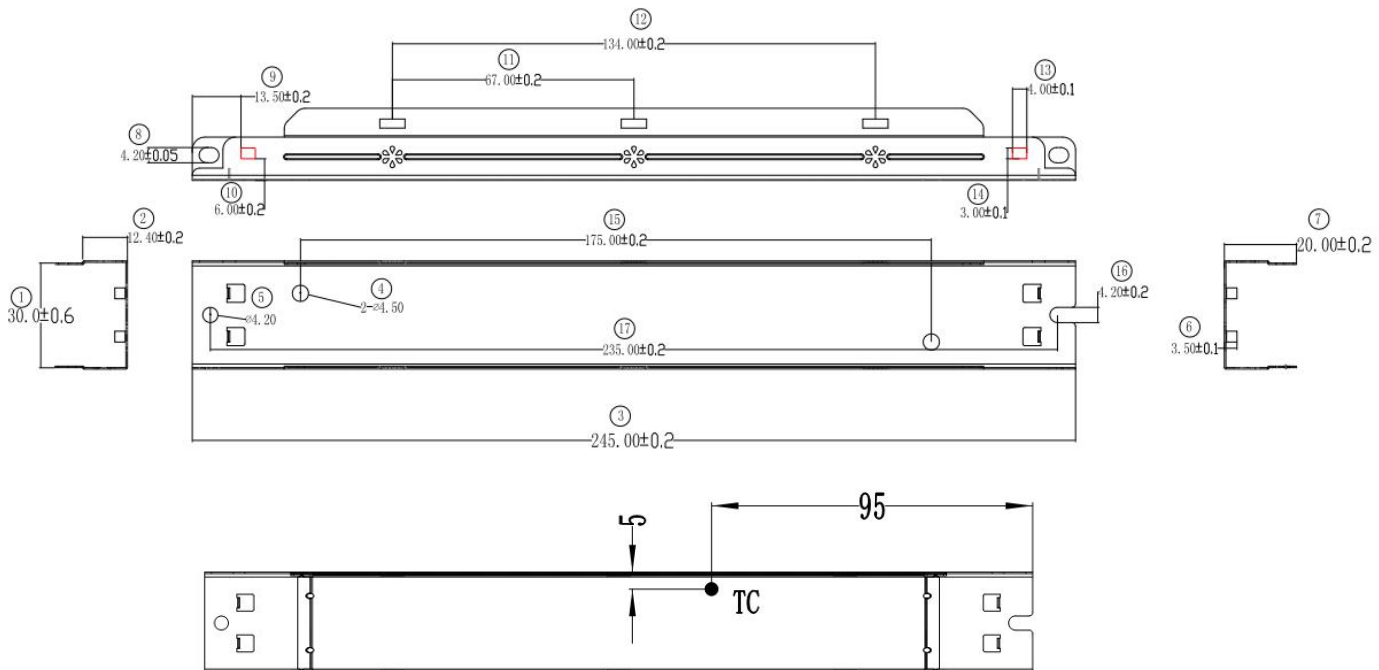

Packaging Specifications

Model	LF-GSD030YE
Packaging Dimension	375×275×280mm (L×W×H)
Quantity	8 pcs/layer; 7 layers/ctn; 56 pcs/ctn
Weight	0.180 kg/pc; 10.18 kg/ctn

Transportation & Storage

■ Transportation

- Suitable transportation means: vehicles, boats and aircraft.
- During transportation, there should be awnings for rain protection and sun protection. Civilized loading and unloading are required. There should be no severe vibration or impact.

■ Storage

- Storage in accordance with the provisions of Class I environment. For products which have been stored for more than six months, they mustn't be used until they pass the re-inspection.

Attention

- Please use this product according to its specifications otherwise there may be malfunction.
- Use light fixtures that have not been certified or are not compatible with the LED drivers may cause fire or other hazards.
- Man-made damage, any use beyond the specification and non-original-factory modification are not covered by warranty.

Remark: The final interpretation right of the contents of this data sheet belongs to Lifud Technology Co., Ltd.