

Product Description

LF-GOE200YH5500-56 series is a 200W DALI programmable constant power LED driver, specifically designed for street lights, tunnel lights, horticulture lighting and landscape lighting projects. Rated voltage: 100-277Vac (limit: 90-305Vac); output voltage: 27-56Vdc; output current: 3000-5500mA. It has features of high surge protection, high waterproof protection, low standby power consumption and low THD, and can be dimmed to off. It is also equipped with all-round protections: surge protection, over-voltage protection, short circuit protection, open circuit protection and over temperature protection, which greatly improves the product stability.

Feature

- Intelligent adaptive constant power: automatically identify the panel voltage and adjust to preset power
- Two-stage flicker free design
- 12V/200mA auxiliary power supply (optional)
- DALI2.0 intelligent control: optional logarithmic or linear dimming curve
- All-round protections: over temperature protection, over-voltage protection, short circuit protection, open circuit protection and IP67
- Surge protection: standard version and enhanced version optional
- 5yrs warranty (Please refer to the warranty description.)



Application

- Street light
- Tunnel light
- Horticulture lighting
- Landscape lighting



Product Naming

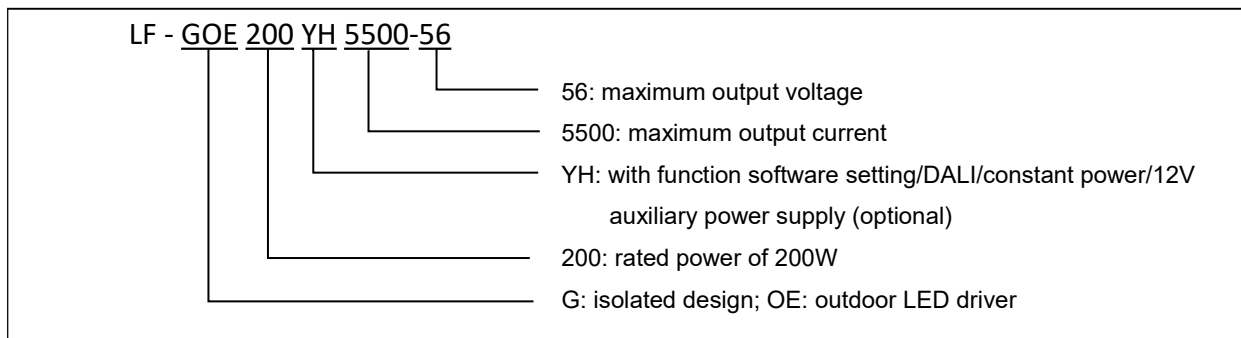

Electrical Characteristic

Model		LF-GOE200YH5500-56
Output	Output Voltage	27-56Vdc (constant power: 36-56Vdc)
	Output Current	3000mA - 5500mA (Intelligent adaptive adjustment)
	Output Power	200W max @100~277Vac
	Ripple Current	Typical: 5%; Maximum: 10%
	Current Tolerance	±5%
	Constant Power Tolerance	±2.5%
	Temperature Drift	±5%
	Start-up Time	<2S@120Vac; <1.5S@230Vac
Input	Input Voltage	100-277Vac (limit: 90-305Vac)
	DC Input Voltage	141-391Vdc (limit: 127-431Vdc)
	Input Frequency	47Hz-63Hz
	Input Current	2.4A Max@100Vac
	Power Factor	≥0.98@120Vac (full load); ≥0.95@230Vac (full load)
	THD	≤10%
	Efficiency	≥93.5% (46V full load)
	In-rush Current	≤100A@350uS
	Leakage Current	≤0.7mA
12V Auxiliary Power Supply (Optional)	Output Voltage	+12Vdc: 11-14V
	Output Current	200mA max
	Dynamic Load	Please make sure the dynamic load matches the product.
	Ripple Voltage	≤1V

Protection Characteristics	Surge Protection	<input checked="" type="checkbox"/> Standard version: L-N:6KV (2Ω), L/N-GND:10KV (12Ω) <input type="checkbox"/> Enhanced version: L-N:6KV (2Ω), L/N-GND:10KV (2Ω)
	Open Circuit Protection	≤63V
	Over Temperature Protection	If the working temperature exceeds the specified temperature, the power will decrease; the power will recover automatically after fault condition is removed.
	Short Circuit Protection	Hiccup mode (auto-recovery)
Environment Description	Operating Temperature	-40℃~+60℃ (200-277Vac); -40℃~+50℃ (100-200Vac)
	Operating Humidity	20-90%RH (no condensation)
	Storage Temperature & Humidity	-40℃~+ 80℃ (six months under class I environment); 10-90%RH (no condensation)
	Atmospheric Pressure	86~106KPa
Safety and Electromagnetic Compatibility	Certification	TUV-ENEC, CCC, CE, RCM, UL (Class P), FCC, SAA, CB
	Withstanding Voltage	I/P-O/P: 3.75kV 5mA 60S; I/P-FG: 1.5kV 5mA 60S; O/P-FG: 0.5kV, 5mA 60S
	Insulation Resistance	I/P-O/P: >100MΩ@500VDC
	Safety Standard	ENEC: EN61347-1:2015, EN 61347-2-13:2014/A1:2017, EN 62384: 2016/A1: 2009 CE-LVD: EN 61347-2-13:2014/A1:2017, EN 61347-1:2015, EN 62493:2015 CB: IEC 61347-1:2015, IEC61347-2-3:2014, IEC 61347-2-13:2014/AMD1:2016 RCM: AS 61347.2-13:2018 CCC: GB19510.1-2009, GB19510.14-2009 UL: UL8750, CSA 250.13
	EMI	CE-EMC/RCM: EN55015, EN61000-3-2, EN61000-3-3 CCC: GB/T17743, GB17625.1, GB17625.2 FCC: part 15B
	EMS	CE-EMC/RCM: EN61000-4-2,3,4,5,6,11 CCC: GB/T17626.2,3,4,5,6,11

Others	IP Rating	IP67
	RoHS	RoHS 2.0 (EU) 2015/863
	Warranty	5 years (Tc: ≤86°C)
	DALI Standard	IEC 62386-101 102 207: DALI 2.0
	MTBF	/
Remarks	<p>1. It is recommended that customer should install protection devices for surge, for over voltage and for undervoltage to ensure safety before connecting to electricity.</p> <p>2. As an accessory, the LED driver is not the only factor determining the EMC performance of the LED light fixture. The structure and the wiring of the light fixture are also relevant. Thus it's strongly recommended the LED light fixture manufacturer re-confirms the EMC of the whole LED light fixture.</p> <p>3. When adjust the output current, please make sure the total output power of the light fixture NOT exceed the maximum rated output power of the driver. ⚠</p> <p>4. Unless otherwise stated, the parameters above are test results under these conditions: ambient temperature of 25°C, humidity of 50%, 100% load and input voltage of 230Vac.</p> <p>5. In compliance with ERP2019, for using the dimmer or system that cannot be dimmed to off to ensure that the LED driver does not enter standby mode.</p>	

Product Characteristic Curve

PF Curve

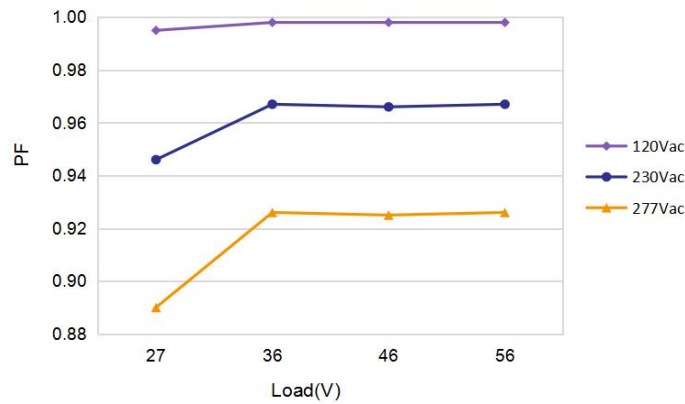

Efficiency Curve

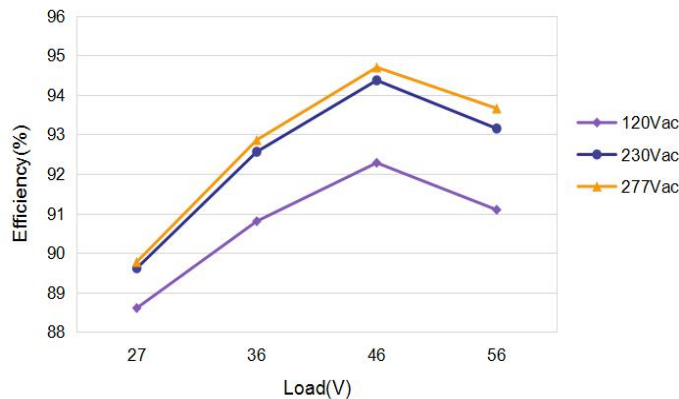

Load Derating Curve

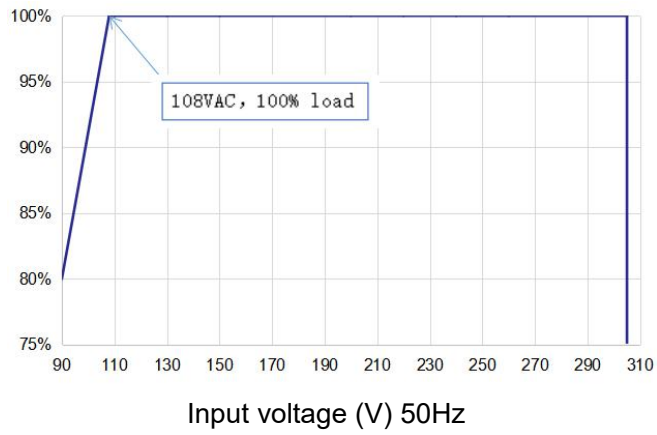

Power Curve

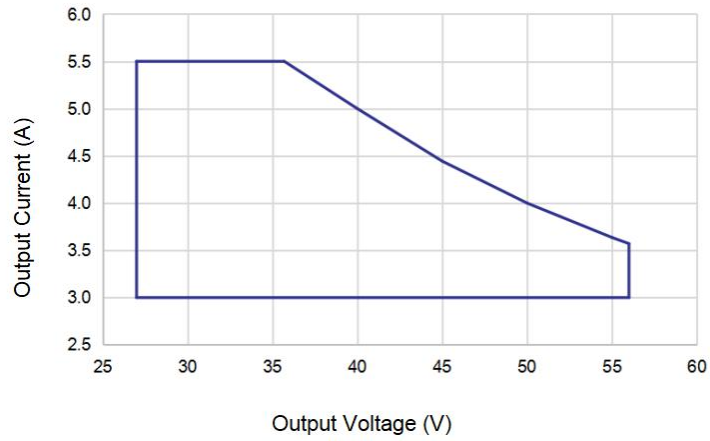

Lifetime Curve

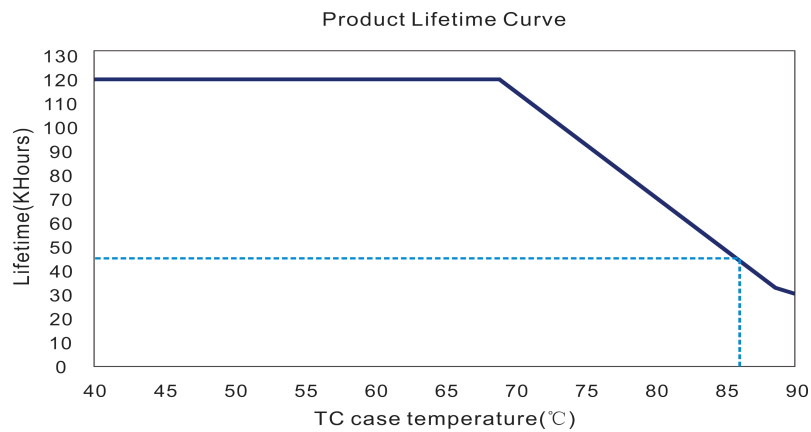

Instruction of Dimming

- Dimming Diagram

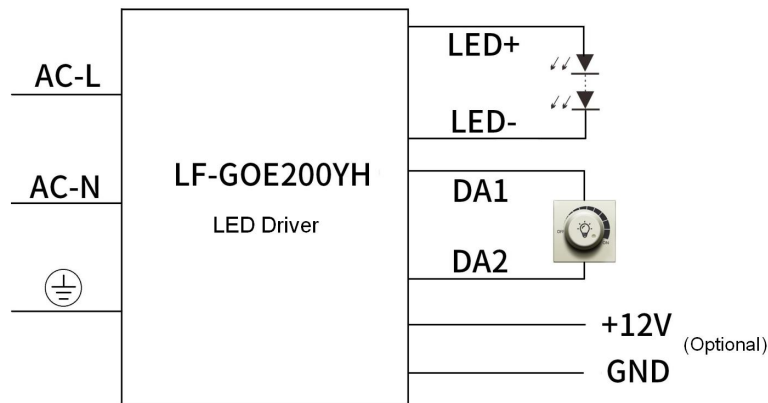

Symbol	EU & US
AC-L	BROWN
AC-N	BLUE
⊕	YELLOW/GREEN
LED+	BROWN
LED-	BLUE
DA1	PURPLE
DA2	GRAY
+12V	PINK
GND	BLACK/WHITE (reference ground of +12V)

- Operations of DALI Dimming

- Factory default setting: 100% brightness, logarithmic dimming curve
- Connect the DALI signal to the DA1 and DA2 terminals.
- DALI protocol includes 16 groups and 64 IP addresses.
- The dimming depth of the DALI dimming is 10% (lout).

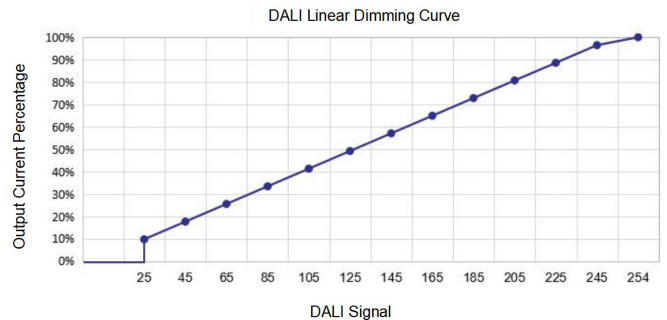
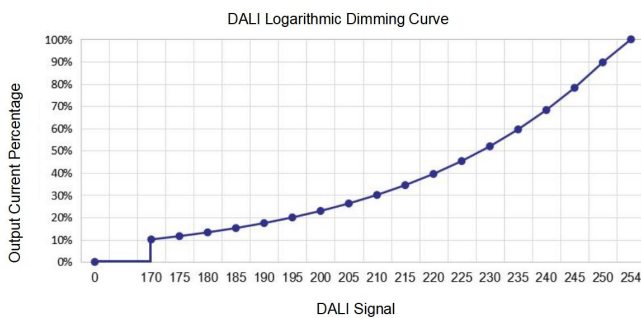

Structure & Dimensions (Unit: mm; tolerance: ±5mm)

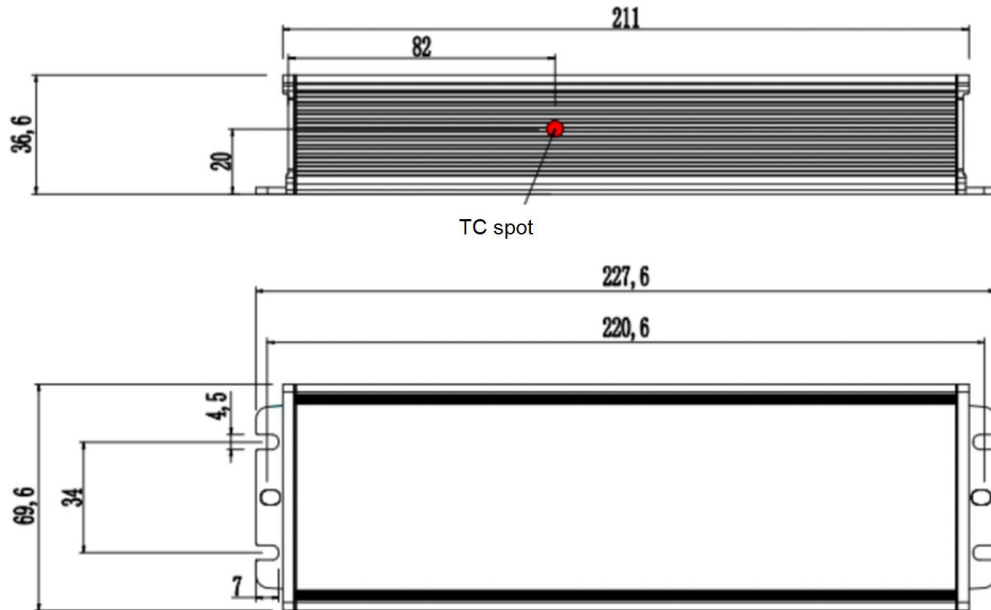

Wire Specification	Input Wire	Output Wire	Dimming&Auxiliary Power Supply Wire
EU & US	3*17AWG (1.04mm ²) Ø8.2±1mm	2*17AWG (1.04mm ²) Ø7.7±1mm	YH: 2*22AWG Ø4.5±1mm Optional: 4*22AWG Ø6.0±1mm
Color	AC-L brown; AC-N blue; GND yellow & green	LED+ brown; LED- blue	DA1 purple; DA2 gray
Length	300±10mm	220±10mm	200±10mm
Peeled	40±5mm	36±5mm	60±5mm
Tinned	10±1mm	6±1mm	10±1mm

Packaging Specification

Model	LF-GOE200YH5500-56
Carton Size	464 x 390 x 184mm (L×W×H)
Quantity	8 pcs/layer; 2 layers/ctn; 16 pcs/ctn
Weight	1.02±0.1 kg/pc; 17.1±1.6 kg/ctn

Transportation & Storage

■ Transportation

- Suitable transportation means: vehicles, boats and aircraft.
- During transportation, there should be awnings for rain protection and sun protection. Civilized loading and unloading are required. There should be no severe vibration or impact.

■ Storage

- Storage in accordance with the provisions of Class I environment. For products which have been stored for more than six months, they mustn't be used until they pass the re-inspection.

Attention

- Please use this product according to its specifications otherwise there may be malfunction.
- Use light fixtures that have not been certified or are not compatible with the LED drivers may cause fire or other hazards.
- Man-made damage, any use beyond the specification and non-original-factory modification are not covered by warranty.

Remark: The final interpretation right of the contents of this data sheet belongs to Lifud Technology Co., Ltd.